

WE TAKE BUILDING AUTO-
MATION PERSONALLY

en

MANUAL EXIGO





THANK YOU FOR CHOOSING REGIN!

Ever since Regin was established in 1947, we have developed and marketed products and systems that create good levels of indoor comfort. Today, we are an important player with one of the market's broadest ranges for building automation.

Our goal is to make real estates in the world more energy efficient. Regin is an international group and our products sells in over 90 countries. Thanks to our global presence with strong local representation, we are well aware of the requirements of the market, as well as of how our products and systems function under the most variable conditions. Every year, Regin makes substantial investments in the development of our systems and HVAC-products.

DISCLAIMER

The information in this manual has been carefully checked and is believed to be correct. Regin makes no warranties about the contents of this manual and users are requested to report errors and discrepancies to Regin, so that corrections may be made in future editions. The information in this document is subject to change without prior notification.

Some product names mentioned in this document are used for identification purposes only and may be the registered trademarks of their respective companies.

© AB Regin. All rights reserved.

Rev. D, 2019-02-12

1	Introduction.....	7
1.1	About this manual.....	7
1.2	More information.....	7
2	Information for the end user.....	8
2.1	Display, LED:s and buttons.....	8
2.1.1	Display.....	8
2.1.2	LED:s.....	8
2.1.3	Summary of the function of the buttons.....	9
2.2	Navigating the menus.....	10
2.3	Changing values.....	11
2.3.1	Editing an existing value.....	11
2.3.2	Enter a completely new value.....	12
2.3.3	Confirm the change.....	12
2.3.4	Undo an initiated change.....	12
2.4	Logging on and off.....	12
2.4.1	Log on.....	13
2.4.2	Log off.....	13
2.4.3	Change password.....	13
2.4.4	Automatic logoff.....	14
2.5	Menu structure.....	14
2.5.1	Actual.....	15
2.5.2	Setpoint.....	15
2.5.3	Temp control.....	21
2.5.4	Manual/auto.....	22
2.5.5	Status.....	22
2.5.6	Mode switch.....	22
2.5.7	Time settings.....	23
2.5.8	Inputs/Outputs.....	24
2.6	Alarm handling.....	25
2.6.1	Alarm priorities.....	25
2.6.2	Inspect alarms.....	25
2.6.3	Acknowledge, block and unblock alarms.....	26
3	Information for the specialist.....	27
3.1	Function overview.....	27
3.1.1	Configuration menu.....	28
3.2	Heating system (HS1–HS4).....	28
3.2.1	Inputs and outputs.....	29
3.2.2	Setpoints.....	31
3.2.3	Control curves / Setpoint.....	32
3.2.4	General settings / Configuration.....	35
3.2.5	Temperature control.....	36
3.2.6	Frost protection.....	37
3.2.7	Shutdown / Pumpstop.....	37
3.2.8	Optimizer / Boost.....	38
3.2.9	Delayed outdoor / Room temperature.....	39
3.2.10	Remote control unit.....	40
3.2.11	Support operation.....	40
3.2.12	Flash adaption.....	40
3.2.13	Wind compensation.....	41
3.2.14	Room compensation.....	41
3.2.15	Temperature limitation.....	42
3.2.16	Power limitation.....	44
3.2.17	Dew point / Dehumidification.....	45
3.2.18	Heating degrees.....	46
3.2.19	Universal limitation.....	46
3.2.20	Bypass.....	48

Table of Contents

3.2.21	Screed drying	48
3.2.22	Pump control	49
3.2.23	Actuator exercise	50
3.2.24	Status	51
3.2.25	Alarms	52
3.2.26	Manual mode	52
3.3	Domestic hot water (HW1, HW2)	53
3.3.1	Inputs and outputs	55
3.3.2	Setpoints	57
3.3.3	General settings / Configuration	57
3.3.4	Frost protection	59
3.3.5	Thermal disinfection	59
3.3.6	Power limitation	60
3.3.7	Blocking heat producer	61
3.3.8	Return temperature limitation	61
3.3.9	Tank control	62
3.3.10	Supply control	62
3.3.11	Circulation	63
3.3.12	Switch off delay	64
3.3.13	Actuator exercise	64
3.3.14	Status	65
3.3.15	Alarms	66
3.3.16	Manual mode	66
3.4	Buffer tank (HP1)	66
3.4.1	Inputs and outputs	67
3.4.2	Setpoints	68
3.4.3	Buffer tank configuration	69
3.4.4	Boost	69
3.4.5	Additional heat source	70
3.4.6	Block heat producer	70
3.4.7	Actuator exercise	70
3.4.8	Status	71
3.4.9	Alarms	71
3.4.10	Manual mode	71
3.5	District heating system (DHS1)	72
3.5.1	Inputs and outputs	72
3.5.2	Setpoints	73
3.5.3	General settings / Configuration	73
3.5.4	Boost	74
3.5.5	Setpoint limitation	74
3.5.6	Supply control	75
3.5.7	Supply limitation	75
3.5.8	Power limitation	76
3.5.9	Frost limitation	76
3.5.10	Return temperature limitation	76
3.5.11	Pump	77
3.5.12	Actuator exercise	78
3.5.13	Status	78
3.5.14	Alarms	79
3.5.15	Manual mode	79
3.6	Solar	79
3.6.1	Inputs and outputs	80
3.6.2	General settings / Configuration	81
3.6.3	Actuator exercise	81
3.6.4	Status	82
3.6.5	Alarms	82
3.6.6	Manual mode	82
3.7	Boiler control (HB1–HB4)	83

3.7.1	Inputs and outputs	83
3.7.2	Setpoint	85
3.7.3	Type of boiler control	87
3.7.4	Boiler settings	89
3.7.5	Starting order	91
3.7.6	Boiler exercise	92
3.7.7	Boiler return temperature	93
3.7.8	Boiler pump	94
3.7.9	Transport pump	96
3.7.10	Manual mode	96
3.8	Pump control	98
3.8.1	Inputs and outputs	98
3.8.2	Parameters	99
3.9	General functions	99
3.9.1	Building inertia	99
3.9.2	Split valve	100
3.10	Priority	100
3.10.1	Priority function	100
3.11	Refill	101
3.11.1	Inputs and outputs	102
3.11.2	Function	102
3.12	Energy / Cold water monitoring	103
3.12.1	Inputs and outputs	103
3.12.2	Pulse meter	103
3.12.3	M-Bus meter	106
3.13	Pressure control	107
3.13.1	Inputs and outputs	107
3.13.2	Setpoint	107
3.13.3	Control pressure	108
3.14	Inputs/outputs	108
3.14.1	General	108
3.15	Alarm settings	110
3.15.1	Alarm limits	110
3.15.2	Alarm delays	110
3.16	Alarm configuration	110
3.16.1	Priority	110
3.16.2	Alarm text	111
3.17	Communication	111
3.17.1	Serial port 1 and 2	111
3.17.2	TCP/IP	115
3.17.3	External display	117
3.17.4	M-Bus ports	117
3.17.5	Expansion units	117
3.17.6	External sensor	117
3.18	System	118
3.18.1	Changing language	118
3.18.2	Choose start screen	118
3.18.3	Automatic summer / winter time adjustment	120
3.18.4	Address	120
3.18.5	Address for remote communication	120
3.18.6	Automatic logoff	120
3.19	Changing the battery	120
3.19.1	24 V models (Exigo Ardo)	121
3.19.2	230 V models (Exigo Vido)	121
4	Information for the installer	122
4.1	Installation	122
4.1.1	Terminals	122

Table of Contents

4.1.2	Wiring	122
4.2	Commissioning	128
4.2.1	Configuration using Exigo tool	128
4.2.2	Configuration using the built-in display or an external display	128
Appendix A Technical data		131
A.1	Exigo Ardo	131
A.1.1	General data	131
A.1.2	Communication ports	131
A.1.3	Inputs & outputs	131
A.2	Exigo Vido	132
A.2.1	General data	132
A.2.2	Communication ports	132
A.2.3	Inputs & outputs	132
Appendix B Model overview		133
Appendix C Input and output lists		134
C.1	Analogue inputs	134
C.2	Digital inputs	136
C.3	Universal inputs	139
C.4	Analogue outputs	139
C.5	Digital outputs	139
Appendix D Alarm list		143
D.1	Heating system 1	143
D.2	Heating system 2	143
D.3	Heating system 3	144
D.4	Heating system 4	144
D.5	Hot water 1	145
D.6	Hot water 2	145
D.7	District heating	146
D.8	Boiler circuit	146
D.9	Boiler 1	147
D.10	Boiler 2	147
D.11	Boiler 3	147
D.12	Boiler 4	148
D.13	Buffer	148
D.14	Solar	148
D.15	Differential pressure	149
D.16	Consumption	149
D.17	Refill	149
D.18	Miscellaneous	149
Appendix E Terminal lists		151
E.1	Exigo Ardo (24 V models)	151
E.2	Exigo Vido (230 V models)	152

I Introduction

I.1 About this manual

This manual covers all the models in the Exigo series used with the heating application. This revision covers software revisions from 4.2.

The manual has the following main chapters:

- ✓ Information for the end user
All the information needed by the end user. How to handle the controller, including how to navigate in the menus, LED:s and indications, how to change setpoints and handle alarms etc.
- ✓ Information for the specialist
A comprehensive guide to all the functions of the controller.
- ✓ Information for the installer
Everything related to the installation of the hardware, such as wiring examples and commissioning.
- ✓ Appendix
Technical data, model overview, input and output lists, alarm list, terminal lists.

Special text formats used in the manual:



Note! This box and symbol is used to show useful tips and tricks.



Caution! This type of text and symbol is used to show cautions.



Warning! This type of text and symbol is used to show warnings.

This box is used to show formulas and mathematical calculations

This box is used to represent the display window on the controller

I.2 More information

More information about the product can be found in:

- ✓ Product sheets for Exigo Ardo and Exigo Vido
- ✓ Instructions for Exigo Ardo and Exigo Vido
- ✓ Variable lists
- ✓ Manual for Exigo tool

All the above documents are available for download from Regin's website, <http://www.regincontrols.com>.

2 Information for the end user

2.1 Display, LED:s and buttons

The controllers are available in two different hardware platforms:

- ✓ The 230 V Exigo Vido which features 5 buttons.



Figure 2-1 Exigo Vido

- ✓ The 24 V Exigo Ardo which features 7 buttons.









Figure 2-2 Exigo Ardo

2.1.1 Display

The display has 4 rows of 20 characters each. It has background illumination. The illumination is normally off, but is activated as soon as a button is pressed. The illumination will be turned off again after a period of inactivity.

2.1.2 LED:s

On the Exigo Ardo models, there are two LEDs on the front, marked with the symbols  and . For controllers with display, the alarm indication and change mode LEDs are located in the keypad area.



Symbol	Colour	Function
	Flashing red	There are one or more unacknowledged alarms.
	Fixed red	There are one or more remaining acknowledged alarms.
	Flashing yellow	You are in a dialog box where it is possible to switch to change mode. A quick blinking (2 times/s) indicates that the parameter can be changed using the current access level. A slower blinking (1 time/s) indicates that a higher access level is required to change the parameter.
	Fixed yellow	You are in change mode.



Status indication

Status indication LEDs can be found in the upper left corner of the Exigo Ardo models.

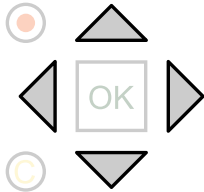
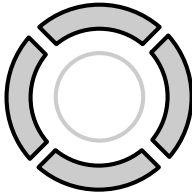
Designation	Colour	Description
P1 RxTx	Yellow/Green	Port 1, receiving/transmitting
P2 RxTx	Yellow/Green	Port 2, receiving/transmitting
TCP/IP (...W models)	Yellow/Green	Green: Connected to other network equipment Blinking green: Network traffic Blinking yellow: For identifying (for example when marking the unit in Exigo tool)
P/B (Power / Battery)	Green/Red	Power on / Battery error

2.1.3 Summary of the function of the buttons

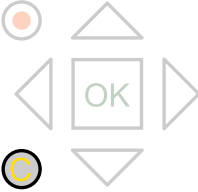
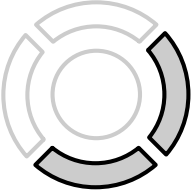
Exigo Ardo (7 buttons)	Exigo Vido (5 buttons)	Functions	Function in Alarm Mode
<p>[▲][▼][▶][◀]</p> 	<p>[▲][▼][▶][◀]</p> 	<p>Navigation buttons:</p> <ul style="list-style-type: none"> ▲ Navigate upwards. ▼ Navigate downwards. ▶ Navigate to the right. ◀ Navigate to the left. <p>In change mode:</p> <ul style="list-style-type: none"> ◀ Move cursor to the left. ▶ Move cursor to the right. ▲ Increase the value by 1. ▼ Decrease the value by 1. ▲ and ▼ Scroll among the texts when there are several alternatives. 	<ul style="list-style-type: none"> ▲ Navigate up in the alarm stack. ▼ Navigate down in the alarm stack. ◀ Exit alarm display mode.
<p>[OK]</p> 	<p>[OK]</p> 	<ul style="list-style-type: none"> ✓ Enter change mode. ✓ Confirm a new value in change mode. An input must be confirmed with this button in order to change the value in the controller. <p>When a value has been confirmed, the cursor will move to the next manoeuvrable value in the current box.</p>	<ul style="list-style-type: none"> ✓ A menu with all available maneuvers that are available for the current alarm is displayed.

Exigo Ardo (7 buttons)	Exigo Vido (5 buttons)	Functions	Function in Alarm Mode
<p>[C]</p> 	<p>[C]</p>  <p>Press both buttons simultaneously</p>	<ul style="list-style-type: none"> ✓ Enter change mode and erase the value in the display. ✓ Erase the sign at the cursor. ✓ When the current value is completely empty, the maneuver mode is cancelled and the cursor will move to the next value that will also be erased in the window. ✓ Undo (erase) the input 	<ul style="list-style-type: none"> ✓ Closes the menu containing available alarm manoeuvres without changing the state of the alarm point.
<p>[ALARM]</p> 	<p>[ALARM]</p>  <p>Press both buttons simultaneously</p>	<ul style="list-style-type: none"> ✓ Enter alarm display mode. 	<ul style="list-style-type: none"> ✓ Browse among alarms in alarm display mode.

2.2 Navigating the menus

The appearance of the start display may vary since there are several different start displays to choose from during configuration.

```

Heating controller
2017-01-08 14:29
HS1
Sp: 52.0 Act: 52.5°C
    
```

Sp and **Act** stand for Setpoint and Actual value. In the example above they are the values for HS1.

Actual value = the current measured temperature

Setpoint = the desired configured temperature

You can navigate through the menu choices at this level by pressing the [▼] and [▲] buttons.

Which menu items are shown depends on the access level of the user and the configured inputs/outputs and functions.

Below, all possible menu entries are shown.

```

HS1
HS2
HS3
HS4
HW1
HW2
Buffer
Boiler
DHS
Solar
Cooling Unit
Time settings
Pressure control
Energy/Cold water
Alarm events
Inputs/Outputs
Configuration
Access rights

```

To enter a higher menu level, press the [▶] button when the display marker is located at the menu item you wish to enter. At each level there may be several new menus through which you may browse using the [▲] and [▼] buttons.

When there are further submenus linked to a menu or menu item, it is indicated by an arrow symbol at the right-hand edge of the display. To choose one, press the [▶] button again. To return to a lower menu level, press the [◀] button.

2.3 Changing values

When you are at a position where it is possible to change one or more values, and your authority is high enough, you can edit the existing value, or enter a completely new one. After changing the value, you confirm the input with the [OK] button, or undo the change by pressing the [C]/ [▼▶] buttons for a short while until the original value reappears in the window and change mode is exited. These manoeuvres are described in detail in the following sections.

2.3.1 Editing an existing value

1. Press the [OK] button to go to change mode. A flashing cursor appears. If there are multiple editable values in one menu, press the [OK] button until the value you want to change flashes.
2. Move the cursor to the right and to the left with the navigation buttons [▶] and [◀].
3. The value at the cursor can now be changed in the following ways:
 - ✓ Erase the current digit or character with the [C]/ [▼▶] buttons.
 - ✓ Use the [▲] and [▼] buttons to increase or decrease the value at the cursor. Maneuverable texts can also be changed with this method.
 - ✓ If the character at the cursor is a decimal point, you cannot browse with the [▲] and [▼] buttons. You can however erase the decimal point with the [C]/ [▼▶] buttons.
 - ✓ If the cursor is placed to the right of the value, i.e. the character at the cursor is a space, you can add a decimal point with the [▼] button, or the figure 0 with the [▲] button.
 - ✓ If you require a negative number, move the cursor to the leftmost position and press the [▼] button to get a minus sign. Then edit the following digits to the required value.
 - ✓ Scroll up [▲] and down [▼] to browse through texts when there are several texts to choose from instead of numerical values.

2.3.2 Enter a completely new value

- ✓ Press the [C] / [▼▶] buttons to go to change mode. The value is erased in the window, and you have to enter a completely new value.
- ✓ If you require a negative number, move the cursor to the leftmost position and press the [▼] button to get a minus sign. Then edit the following digits to the required value.
- ✓ Press [▲] to begin the input with the figure 0, then browse to the required figure or character with [▲] and [▼].
- ✓ Press [▼] to get a decimal point. When the cursor is placed at a decimal point, you cannot browse with the [▲] and [▼] buttons.

2.3.3 Confirm the change

Press [OK] to confirm the change when the required value has been entered. Then the value you see in the window will be updated in the installation.

After the value has been confirmed, the cursor will move to the next maneuverable value in the current menu.



Note! As long as you don't confirm a change with the [OK] button, no change will be made in the installation.

2.3.4 Undo an initiated change



Note! As long as you don't confirm a value with the [OK] button, you can undo an initiated change by pressing the [C] / [▼▶] buttons for a short while until the original value reappears in the window and change mode is exited.

2.4 Logging on and off

The controller has four different access levels. The choice of access level determines which menus are shown, as well as which parameters can be changed in the displayed menus.

- ✓ **Normal** level does not require logging on, and only permits changes in running mode and gives read-only access to a limited number of menus.
- ✓ **Operator** level gives the same access as **Normal** level, and in addition, access to change setpoints.
- ✓ **Service** level gives the same access as **Operator** level, and in addition, access to change controller settings and manual mode.
- ✓ **Admin** level gives full read/write access to all settings and parameters in all menus.

2.4.1 Log on

1. Browse to **Access Rights** in the main menu and press [►].

```
Log on
Log off
Change password
```

2. Select **Log on** and press [►].

```
Log on
Enter password:****
Actual level:
None
```

3. Press [OK] to make a cursor marker appear at the first digit position.
4. Enter the password (4-digit code) by pressing [▲] until the correct digit is displayed. Press the [►] to move to the next position. Repeat the procedure until all four digits are displayed, and press [OK] to confirm.

2.4.2 Log off

1. Go to **Access Rights** in the main menu and press [►].
2. Select **Log off** and press [►].

```
Log off?
No
Actual level:
Admin
```

3. Select **Yes** and press [OK].

2.4.3 Change password

1. Go to **Access Rights** in the main menu and press [►].
2. Select **Change password** and press [►].

```
Change password for
level:Operator
New password: ****
```

3. Select **Yes** and press [OK]
4. Press [OK] to enter change mode.
5. Use the [▲] and [▼] buttons to browse and select the access level to change the password for, and press [OK] to confirm.

6. Enter the new password (4-digit code) by pressing [**▲**] until the correct digit is displayed. Press the [**▶**] to move to the next position. Repeat the procedure until all four digits are displayed, and press [**OK**] to confirm.

The following passwords are the default for the different access levels:

Access level	Password
Admin	1111
Service	2222
Operator	3333
Normal	5555

You can only change the password for access levels lower or equal to the presently active level, i.e. if you are logged in as **Admin** you can change all passwords, but as **Operator** you can only change the **Operator** and **Normal** passwords. There is no point in changing the **Normal** password since access to that level is granted automatically to all users.



Caution! Do not set the password for two different access levels to the same value, as this would prevent access to the higher of these two access levels. This is especially important for the **Admin** level.



Note! If the password for the **Admin** level has been changed and then lost, a temporary password can be obtained from . This code is date dependent and valid for one day only.

2.4.4 Automatic logoff

When logged in as **Operator**, **Service** or **Admin**, the user will automatically be logged off to **Normal** after a settable time of inactivity (the default is 60 seconds). It is possible to set the controller to disable the automatic logoff.

Change password to remove automatic logoff

If you want to remove the automatic logoff, change the password of the desired level to 0000. This can be very useful in certain cases if the unit is intended to be used by trained personnel or, for instance, during commissioning.



Note! Removing the automatic logoff should be done with consideration, since no alarm is continuously given that a certain level has been activated.

2.5 Menu structure

Only the configured circuits are included in the main menu.

```

HS1
HS2
HS3
HS4
HW1
HW2
Buffer
Boiler
DHS
Solar
Cooling unit
Time settings
Pressure control
Energy/Cold water
Alarm events
Inputs/Outputs
Configuration
Access rights

```

- ✓ Heating system (HS1 – HS4)
- ✓ Domestic hot water (HW1 – HW2)
- ✓ Buffer
- ✓ Boiler
- ✓ District heating system (DHS)
- ✓ Solar

Each of these circuits has up to five submenus:

```

Actual
Setpoint
Temp control
Manual/Auto
Status

```

- ✓ Actual
- ✓ Setpoint
- ✓ Temp control
- ✓ Manual/Auto
- ✓ Status

2.5.1 Actual

In this submenu, you can read all the actual values of the configured inputs of the circuit. For more information, see *chapter 3 Information for the specialist*

2.5.2 Setpoint

In this submenu, you can read and set all the setpoints for the selected circuit. You need **Operator** access level or higher to be able to change setpoints.

Heating system (HS1–HS4)

There are three different setpoint types for heating systems. Each heating system is configured as one of these setpoint types:

- ✓ Constant setpoint
- ✓ 8-point curve

- ✓ DIN-curve with slope and exponent (only for heating mode)

Only the parameters relevant for the configured setpoint type are visible in the menu.

Constant setpoint

If the setpoint type is set to constant, the setpoint is the same regardless of the outdoor temperature.

```
Heating Constant
SetP: 45.0 °C
```

8-point curve

If the setpoint type is set to 8-point curve, the setpoint depends on the outdoor temperature by means of a control curve. At 8 settable outdoor temperatures, a corresponding supply temperature is entered.

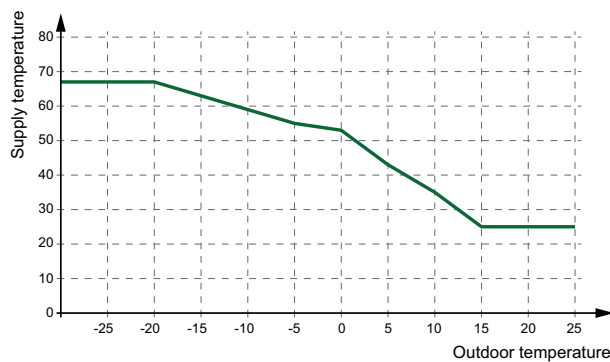

Figure 2-3 8-point curve

```
Heating Outd Comp
-20 °C = 67 °C
-15 °C = 63 °C
-10 °C = 59 °C
```

```
Heating Outd Comp
-5 °C = 55 °C
0 °C = 53 °C
5 °C = 43 °C
```

```
Heating Outd Comp
10 °C = 35 °C
15 °C = 25 °C
```

A displacement can be added to the 8-point control curve to move the entire curve up or down.

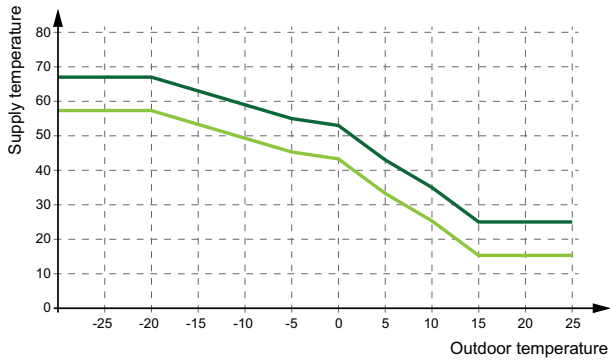

Figure 2-4 8-point curve with displacement

Heating Manual
 Displacement
 0 °C

DIN curve with slope and exponent

If the setpoint type is set to DIN curve, the setpoint depends on the outdoor temperature by means of a control curve with settable slope and an exponent which bends the curve.

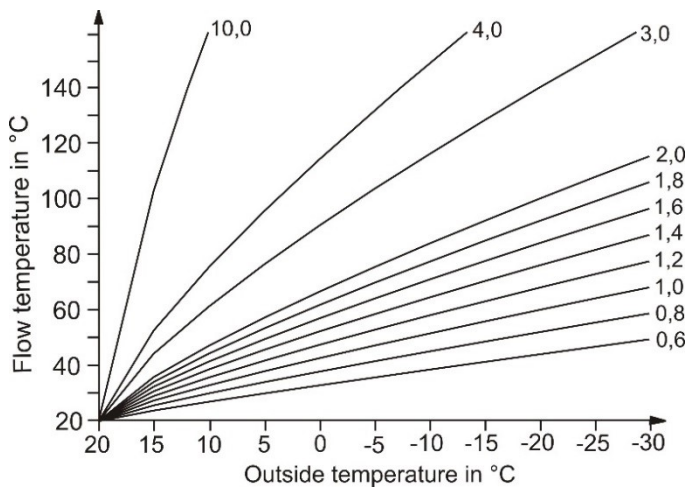

Figure 2-5 DIN curve slope

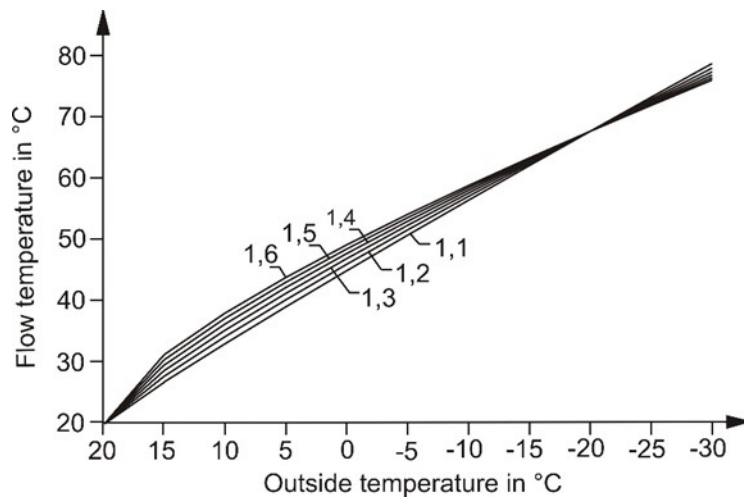

Figure 2-6 DIN curve exponent

Some commonly used exponents are:

- ✓ 1.10 underfloor heating
- ✓ 1.20 radiators
- ✓ 1.33 DIN-radiators
- ✓ 1.25...1.40 plate radiators
- ✓ 1.40...1.60 convectors

```
Heating Outd Comp
Slope: 1.4
Exponent: 1.30
```

Room setpoints can be set for the four settable Comfort times (SP-CT1...SP-CT4) and are valid for both types of heating curves. The night setpoint and the holiday setpoint are calculated as a difference (Diff-NCT or Diff-Hol) to the setpoint of the following comfort time or of comfort time 1 (during holiday or if the time to the next comfort time > 24h). The difference will decrease the setpoint in heating mode and increase it in cooling mode. How much the setpoint is changed depends on the calculated supply setpoint and on the difference between the current setpoint of the room and the basic setpoint of 21 °C.

A reduction of the heating setpoint to 0 °C or an increase of the cooling setpoint to 35 °C will stop the heating system.

For more information, see 2.5.7 *Time settings*.

```
Room
SP-CT1: 20.0 °C
SP-CT2: 20.0 °C
SP-CT3: 20.0 °C
```

```
Room
SP-CT4: 20.0 °C
```

```
Room
Diff-NCT: 5.0 °C
Diff-Night: 5.0 °C
Diff-Hol: 15.0 °C
```

Cooling mode

The same setpoints are available for cooling mode as for heating mode except that curve with slope and exponent is not available.

```
Cooling Outd Comp
20 °C = 15 °C
22 °C = 14 °C
24 °C = 13 °C
```

```
Cooling Outd Comp
26 °C = 12 °C
28 °C = 12 °C
30 °C = 11 °C
```

```
Cooling Outd Comp
32 °C = 10 °C
34 °C = 9 °C
```

```
Cooling Constant
SetP:13 °C
```

```
Cooling Manual
Displacement
0 °C
```

Dehumidification

The dehumidification function can use either a constant setpoint or a calculated setpoint. If constant setpoint is used, it can be set in the **Setpoint** menu. For more information, see *chapter 3 Information for the specialist*

```
Dehumidification
SetP: 55 %RH
```

Domestic hot water (HW1–HW2)

Each domestic hot water system has setpoints for the four settable *Comfort times* (SP-CT1...SP-CT4), a night setpoint (SP-NCT) and a holiday setpoint (SP-Hol).

```
Hot Water SetP
SP-CT1: 50 °C
SP-CT2: 50 °C
SP-CT3: 50 °C
```

```
Hot Water SetP
SP-CT4: 50 °C
SP-NCT: 2 °C
SP-Hol: 2 °C
```

Buffer

The program can control buffer tanks with one zone. The **Setpoint** menu displays the currently calculated buffer temperature setpoint **Setpoint Act** based on the demand from the internal heating circuits, the domestic hot water circuits and external heat consumers or on the **Constant Setpoint** depending on the

settings. A **Hysteresis** can also be set in order to overheat the buffer tank for switching off the heat producers.

```
Setpoint
Act: 12.0 °C
Hysteresis: 5.0 °C
```

```
Constant Setpoint
SetP: 50.0 °C
```

Boiler (HB1–HB4)

The boiler control setpoint type can be configured to one of the following alternatives, and only the parameters relevant for the configured setpoint type are visible in the menu.

```
Outd Temp: 17.0 °C
HB
Act: 5.0 °C SetP->
SetP: 20.0 °C
```

✓ Constant setpoint: A fixed settable value, **SetP**.

```
HB Setpoint
Setp: 36.0 °C
```

✓ Circuit-dependent setpoint: Can be set to any of the following options:

1. HS-dependent
2. HW-dependent
3. HP1-dependent
4. HS- and HW-dependent
5. HS- and HP1-dependent
6. HW- and HP1-dependent
7. HS-, HW- and HP1-dependent

When a circuit-dependent setpoint has been configured, the boiler control setpoint is dependent on the setpoints of other circuits. The circuit whose setpoint is currently the highest will, together with an added offset, **Man Paral Dis**, (pre-set to 5 degrees), constitute the boiler control setpoint.

```
Offset HS Setpoint
5.0 °C
HB Act: 48.6 °C
HB Setp: 35.3 °C
```

✓ Outdoor compensated setpoint = the setpoint varies with the outdoor temperature.

At 8 settable outdoor temperatures, a corresponding supply temperature is set.

```
Outd Comp Setp HB
-20.0 °C = 67 °C
-15.0 °C = 63 °C
-10.0 °C = 59 °C
```

```
Outd Comp Setp HB
-5.0 °C = 55 °C
-0.0 °C = 53 °C
5.0 °C = 43 °C
```

```
Outd Comp Setp HB
10.0 °C = 35 °C
15.0 °C = 25 °C
Man Paral Dis 0°C
```

Pressure control

This menu shows the setpoint and the actual control pressure value.

```
Pressure control
Act: 51 kPa
SetP: 50 kPa
```

2.5.3 Temp control

In this submenu, the control parameters can be read and set. It is only visible for access level **Operator** and higher, and only manoeuvrable for access level **Service** and higher. For more information, see *chapter 3 Information for the specialist*

2.5.4 Manual/auto

In this submenu, pumps, valves and other functions of the circuit can be set to manual mode. It is only visible for access level **Operator** and higher, and only manoeuvrable for access level **Service** and higher. For more information, see *chapter 3 Information for the specialist*

2.5.5 Status

In this submenu, the status of the circuit can be read. Each circuit has a main status that can have the following modes:

Status	HS	HW	DHS	Buffer	Solar	Description
Not active	✓	✓	✓	✓	✓	Circuit is not active and will do nothing. Reason: Missing sensor or Mode switch = Off
Frost	✓	✓	✓			Circuit is in frost-protection because one of the sensors is lower than the frost limit. Frost protection is not working if the status is set to <i>Not active</i> .
Switch off	✓	✓	✓	✓	✓	No control function because there is no demand, the main switch of the circuit is not active, unit shut down or switch off by the priority function. Frost protection is still active.
Support operation	✓	✓				Circuit is working with reduced setpoint because either the time channel is outside of a comfort time or reduction by the priority function.
Normal operation	✓	✓	✓	✓	✓	Normal operation, circuit is controlling the demand or comfort setpoint.
Holiday	✓	✓				Time channel is in ECO mode during a holiday period. The holiday setpoint is controlled by the circuit.
Screed drying	✓					Heating system is working in <i>Screed drying</i> mode.

Each function also has different sub-statuses. For more information, see *chapter 3 Information for the specialist*

2.5.6 Mode switch

In addition to the items in the main menu, there is also an extra menu called **Mode switch**, that is reached by pressing [▶] in the main menu. The mode switch changes the operation of the system.

Mode switch position	Heating system	Domestic hot water system	Buffer / Solar / Boiler / District heating system
0 — Off	Off-mode. No control function, valves closed, pumps off.		
1 — Auto	Automatic mode. Control function depending on timer and settings.		Automatic mode, working on demand.
2 — Summer	No heating, which means switch off operation if in heating mode, and automatic operation in cooling mode.	Same as automatic mode.	Same as automatic mode.
3 — Holiday	Holiday operation with setpoint Holiday		Same as automatic mode.
4 — Continuous	Normal operation with setpoint CT1		Same as automatic mode.

2.5.7 Time settings

The controller is equipped with a maximum of 11 week programs (time schedules) and year programs (holiday schedules). One schedule is assigned to each heating circuit and each domestic hot water circuit. Additionally, there are five extra schedules that can be used for multiple purposes, for example to control lighting or door locks etc.

The extra schedules can be assigned to output terminals. These switch on/off in accordance with up to four specified comfort times (switched on during the specified comfort times, switched off in between the comfort times).

The **Time settings** menu contains the submenus **Time/Date**, **Time schedule** and **Holiday schedule**.

Time/date

This menu displays time, date and weekday, and it permits the setting of time and date.

Time is shown in 24 hour format. Date is shown in the format YY:MM:DD.

Time schedule

In the time schedules, four comfort times are available for each day of the week. Also, four comfort times are available for days that are configured as holidays in the holiday schedule. During the comfort times the assigned circuit is working with the corresponding setpoint (CTx setpoint). Outside of a comfort time the Eco setpoint is valid or the night setpoint will be activated.

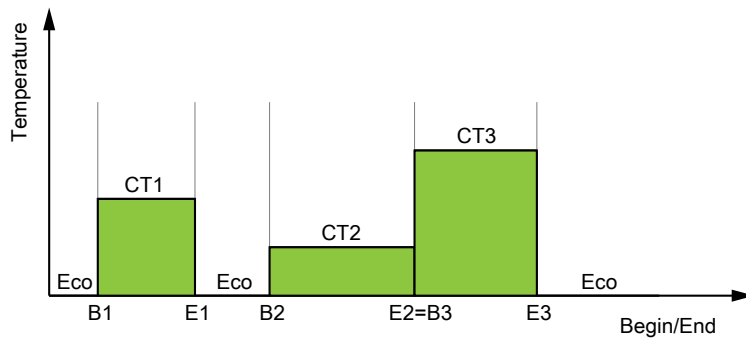

Figure 2-7 Time schedule

The above figure shows an example of comfort time (CTx) states. As shown, the end of an comfort time is followed either by a non-operating time (Eco) or by the beginning of a new comfort time (see E2=B3 in the figure). It is not possible for comfort times to overlap each other.

Parameters

Name	Unit	Min	Max	Default	Description
Monday Per.1 Start	hh:mm	00:00	24:00	07:00	Start of comfort time 1 Mondays.
Monday Per.1 End	hh:mm	00:00	24:00	16:00	End of comfort time 1 Mondays.
Monday Per.2 Start	hh:mm	00:00	24:00	00:00	Start of comfort time 2 Mondays.
Monday Per.2 End	hh:mm	00:00	24:00	00:00	End of comfort time 2 Mondays.
Monday Per.3 Start	hh:mm	00:00	24:00	00:00	Start of comfort time 3 Mondays.
Monday Per.3 End	hh:mm	00:00	24:00	00:00	End of comfort time 3 Mondays.
Monday Per.4 Start	hh:mm	00:00	24:00	00:00	Start of comfort time 4 Mondays.
Monday Per.4 End	hh:mm	00:00	24:00	00:00	End of comfort time 4 Mondays.
...					

Name	Unit	Min	Max	Default	Description
Holiday Per.1 Start	hh:mm	00:00	24:00	07:00	Start of comfort time 1 holidays.
Holiday Per.1 End	hh:mm	00:00	24:00	16:00	End of comfort time 1 holidays.
Holiday Per.2 Start	hh:mm	00:00	24:00	00:00	Start of comfort time 2 holidays.
Holiday Per.2 End	hh:mm	00:00	24:00	00:00	End of comfort time 2 holidays.
Holiday Per.3 Start	hh:mm	00:00	24:00	00:00	Start of comfort time 3 holidays.
Holiday Per.3 End	hh:mm	00:00	24:00	00:00	End of comfort time 3 holidays.
Holiday Per.4 Start	hh:mm	00:00	24:00	00:00	Start of comfort time 4 holidays.
Holiday Per.4 End	hh:mm	00:00	24:00	00:00	End of comfort time 4 holidays.

Holiday schedule

The system operator can define specific periods of operation or non-operation throughout the year. During these defined periods, the settings in the week schedule do not apply. The holiday schedule provides 10 periods for each timer module. All holiday periods of a time schedule are working with a special day plan with a maximum of 4 comfort times. During these comfort times, the assigned circuit is working with the corresponding setpoint (**Setpoint CTx**). Outside of a comfort time, **Setpoint Holiday** is in use or **Night Setback holiday** will be activated.

Name	Unit	Min	Max	Default	Description
Holiday Per.1 Start	MM:DD	01.01	31.12	00.00	The start date of holiday period 1.
Holiday Per.1 End	MM:DD	01.01	31.12	00.00	The end date of holiday period 1.
...					
Holiday Per.10 Start	MM:DD	01.01	31.12	00.00	The start date of holiday period 10.
Holiday Per.10 End	MM:DD	01.01	31.12	00.00	The end date of holiday period 10.

2.5.8 Inputs/Outputs

This is a read-only menu showing the current values for all inputs and outputs. If correction factors have been applied to the input values, the corrected values are shown.

```
AI/UAI
WAI
DI/UDI
AO
DO
```

Analogue inputs

```
AI1-2.9 UAI1 1.0
AI2 20.3 UAI2-3.2
AI3 28.2 UAI3 22.3
AI4 19.9 UAI4 14.4
```

Wireless inputs

```
WAI1-0.9 WAI5 21.5
WAI2 3.7 WAI6 22.9
WAI3 1.5 WAI7 17.3
WAI4 2.1 WAI8 16.8
```



```

WAI9 -0.9 WAI13 21.5
WAI10 3.7 WAI14 22.9
WAI11 1.5 WAI15 17.3
WAI12 2.1 WAI16 16.8

```

Digital inputs

```

DI1 Off  DI5 Off
DI2 Off  DI6 On
DI3 On   DI7 On
DI4 Off  DI8 Off

```

```

UDI1 Off
UDI2 Off
UDI3 Off
UDI4 Off

```

Analogue outputs

```

AO1 10.0  AO5 2.3
AO2 0.0
AO3 5.7
AO4 3.8

```

Digital outputs

```

DO1 Off  DO5 On
DO2 Off  DO6 Off
DO3 On   DO7 On
DO4 Off

```

2.6 Alarm handling

If an alarm condition occurs, an alarm is logged in an alarm list. The list shows the type of alarm, the alarm date and time and the alarm priority (A, B or C alarm).

2.6.1 Alarm priorities

Alarms can be given different priority levels: A alarm, B alarm, C alarm or not active. There are three digital outputs that can be used as alarm outputs: Sum alarm, Sum alarm A and Sum Alarm B/C.

A, B and C alarms all activate the sum alarm output, if it has been configured.

Class A alarms also activate sum alarm A, and class B/C alarms activate sum alarm B/C.

Class C alarms are removed from the alarm list when the alarm input resets even if the alarm has not been acknowledged.

2.6.2 Inspect alarms

- ✓ Press the alarm buttons [ALARM] / [◀▲] to display the alarms.

- ✓ If there is more than one alarm at the same time, this is indicated by up/down arrow symbols at the right-hand edge of the display. You can browse among them in two ways:
 1. By using the navigation buttons [▼] and [▲].
 2. By pressing the alarm buttons [ALARM] / [◀▲] several times.
- ✓ Press [◀] to exit alarm handling and return to the previous menu.

2.6.3 Acknowledge, block and unblock alarms

- ✓ Press the [OK] button to get a menu with the available alarm maneuvers for the currently displayed alarm.
- ✓ Select the required alarm maneuver with the buttons [▼] and [▲].
- ✓ Press the [OK] button to execute the maneuver.

At the left end of the bottom display line the alarm status is shown. For active, unacknowledged alarms the space is blank. Alarms that have been reset are indicated by the text Acknowledged. Active or blocked alarms are indicated by the text Acknowledged or Blocked.

Acknowledged alarms will remain on the alarm list until the alarm input signal resets.

Blocked alarms remain on the alarm list until the alarm has been reset and the block has been removed. New alarms of the same type will not be activated as long as the block remains.



Caution! Blocking alarms can be potentially dangerous. A high log on authority is therefore required to block alarms.

Alarm events

In the **Alarm Events** menu, there is an alarm log which contains the 40 latest alarm events. The latest event is shown at the top of the list. The alarm log is only used to view alarm history, which may simplify troubleshooting of the installation.

3 Information for the specialist

3.1 Function overview

The temperature controllers are PI-controllers for control of heating, cooling, boilers and PID for domestic hot water control. A number of different control functions, as well as analogue and digital inputs and outputs, can be added to these controllers. The user can freely decide which functions to use. The only restriction is the number of physical inputs and outputs of the different models.

Among other things, the program includes the following functions:

Heating system

The controller can be equipped with up to 4 heating systems for heating and cooling. The basic function of the heating systems is outdoor temperature and/or room temperature-dependent control of the supply or return temperature.

Hot water system

The controller can be configured for one or two domestic hot water systems, HW1 and HW2. There are six different types of domestic hot water systems available, flow through system as well as different storage loading systems.

District heating system

The controller can control a District heating circuit. This function permits demand-based control of a district heating unit with or without a heat exchanger (direct heat supply).

Boiler

For control of 1-4 boilers in sequence, 1-step, 2-step or modulating burners. It is possible to choose between either a fixed or an outdoor compensated setpoint, or to use the highest setpoint in any other heating systems that have been configured.

Buffer tank

A buffer tank has many positive effects on a system, including reducing starts and stops from a boiler. The temperature in the buffer tank is controlled according to the demands of the heating systems and domestic hot water systems, as well as external demand via 0...10 V.

Solar

The solar system can be used either for heating the domestic hot water storage tank or in order to heat up the buffer tank. The basic function of the solar circuit is to control the temperature difference between the collector sensor and the storage sensor.

Time channel

A maximum of 11 time schedules are available. One time schedule is assigned to each heating system and domestic hot water system. Additionally, there are 5 free time schedules which can be used for multiple purposes.

Differential pressure control

One constant differential pressure control circuit.

Priority

The priority function permits defining if and how the HW or HS should have priority over the other heat consumers, when heat is required. This function is needed when the heat producer is unable to simultaneously supply heat to all heat consumers.

Monitoring

Monitoring the energy and water consumption via digital pulse input or M-Bus-meter.

3.1.1 Configuration menu

The different functions are configured from the **Configuration** menu, which can be found in the main menu. To access this menu, you have to be logged in as **Admin**.

The configuration menu contains the following items:

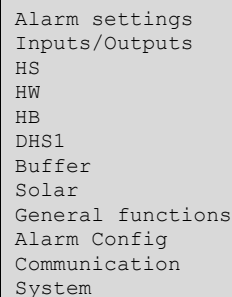

```
Alarm settings
Inputs/Outputs
HS
HW
HB
DHS1
Buffer
Solar
General functions
Alarm Config
Communication
System
```

- ✓ Alarm settings: Configuration of alarm limits and delays
- ✓ Inputs/Outputs: Configuration of inputs and outputs
- ✓ HS: Configuration of heating systems (HS1-4)
- ✓ HW: Configuration of domestic hot water systems (HW1, HW2)
- ✓ HB: Configuration of boilers
- ✓ DHS1: Configuration of district heating system (DHS1)
- ✓ Buffer: Configuration of a buffer tank
- ✓ Solar: Configuration of a solar circuit
- ✓ General functions: Configuration of the *Priority* function, general heating parameters that are mutual for all 4 heating systems and configuration of the *Energy/Cold water monitoring* function
- ✓ Alarm Config: Configuration of the alarm priority for each alarm
- ✓ Communication: Configuration of communication ports
- ✓ System: Configure language, start screen and other system settings

3.2 Heating system (HS1–HS4)

There are two different types of heating circuits, mixed and unmixed. Both types can work in heating or cooling mode.

1. Mixed heating circuit

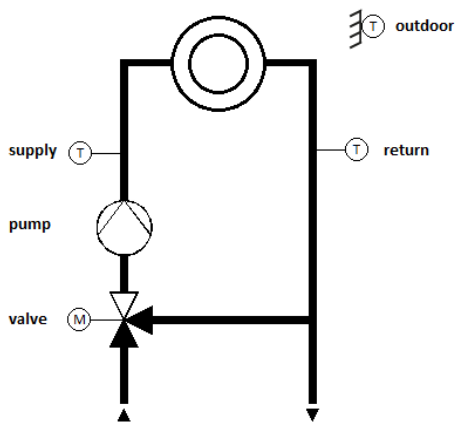

Figure 3-1 Mixed heating circuit

2. Unimixed heating circuit

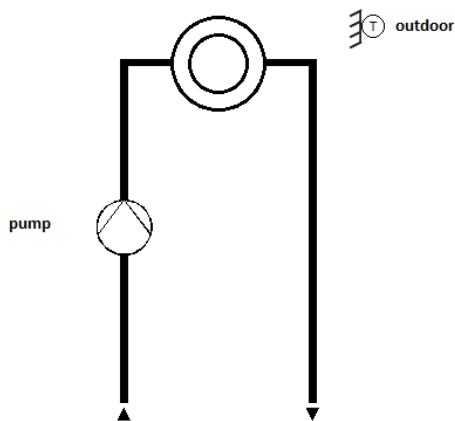

Figure 3-2 Unimixed heating circuit

Different control strategies can be used depending on the configuration of the inputs:

Input				Control strategy used	Setpoint	Demand
Outdoor sensor	Supply sensor	Return sensor	Room sensor			
✓	✓	✓	✓	Supply temp control or return temp control	Curve + adaption	Supply control: setpoint Return control: setpoint + offset
✓	✓	✓	-		Curve	
-	✓	✓	✓		Constant + adaption	
-	✓	✓	-		Constant	
✓	-	-	✓	Room temp	Constant	Curve + adaption
✓	-	-	-	Pump only	-	Curve
-	-	-	✓	Room temp	Constant	Setpoint if control signal > 0%

3.2.1 Inputs and outputs

The following inputs and outputs are used for heating systems.

Analogue inputs

Name	Unit	Description
Outdoor temperature	°C	Frost protection, calculation of curve-setpoint.
Supply temperature	°C	Control sensor at supply control or limitation sensor at return control.
Room temperature	°C	Control sensor in room control mode or used for room adaption.
Return temperature	°C	Used as control sensor at return control, as limitation sensor at supply control and for the HP-Return temperature limitation.
Primary return temperature	°C	Used for the return temperature limitation.
Limitation sensor	°C	Used for the universal limitation.
Shift sensor	°C	Used for the universal limitation to shift the limit depending on this input.
Heat capacity	kW	For primary limitation of heating capacity; function capacity limitation.
Wind speed	m/s	For a parallel adjustment of the curve.
Room humidity	%RH	Humidity in the room.
Differential pressure	kPa	Differential pressure at the pump.
Extra sensor 1	°C	Extra sensor that can be used by the remote control unit function.
Extra sensor 2	°C	Extra sensor that can be used by the remote control unit function.
Extra sensor 3	°C	Extra sensor that can be used by the remote control unit function.
Extra sensor 4	°C	Extra sensor that can be used by the remote control unit function.
Extra sensor 5	°C	Extra sensor that can be used by the remote control unit function.

Digital inputs

Name	Unit	Description
Main switch	Off/On	To shut off the system; change the status between Auto and Switch Off .
Extended run	Off/On	Extended run of the heating system.
ChangeOver	Off/On	Change to Cooling mode. 0 = Auto 1 = Cooling
CoolStart	Off/On	"Cooling water" in the system, heating system can start cooling or must stop heating.
Thermostat	Off/On	To let the heating system work in "Thermostat mode".
Run indication / alarm pump A	Off/On; Normal/ Error	Feedback from circulation pump A depending on the type of feedback. Motor protection: 0 = Okay 1 = Error Run indication: 0 = Off 1 = Running
Run indication / alarm pump B	Off/On; Normal/ Error	Feedback from circulation pump B (optional for motor protection). If there is no input configured, the function will use input for pump A for both pumps.
Heating closed	Off/On	Feedback that the actuator to connect to heating is closed.
Cooling closed	Off/On	Feedback that the actuator to connect to cooling is closed.
High supply temperature	Off/On	Input to activate the alarm for high supply temperature.
Condensation	Off/On	Input to stop cooling in case of condensation.

Analogue outputs

Name	Unit	Description
Valve continuous	%	Used to control an actuator with continuous control.
Pump continuous	%	Used to control a pump with continuous control.

Digital outputs

Name	Unit	Description
Valve open	Off/On	Used to control an actuator with open/close control.
Valve close	Off/On	Used to control an actuator with open/close control.
Pump A	Off/On	Used to control a single pump or the first pump of a double pump.
Pump B	Off/On	Used to control the second pump of a double pump.
Dehumidification	Off/On	Used to control a humidifier.
Bypass	Off/On	Used to bypass the cooling system.
Heating start	Off/On	Output to connect the system to the heating system.
Cooling start	Off/On	Output to connect the system to the cooling system.

3.2.2 Setpoints

It is possible to change the room setpoint for the different operation times and the night setback.

The room setpoints are used in three different functions:

1. As a starting point of the DIN-curve to calculate the output of the curve.
2. To do a parallel adjustment of the 8-point curve depending on the difference between the setpoint and the default value of 21 °C.
3. As an input of the room compensation if a room sensor is configured.

Room setpoints can be set for the four settable comfort times (**Room SP-CT1**...**Room SP-CT4**) and are valid for both types of heating curves. The NCT setpoint, the night setpoint and the holiday setpoint are calculated as a difference (**Room Diff-NCT**, **Room Diff-Night** or **Room Diff-Hol**) to the setpoint of the following comfort time or of comfort time 1 (during holiday or if the time to the next comfort time > 24h). The difference will decrease the setpoint in heating mode and increase it in cooling mode. How much the setpoint is changed depends on the calculated setpoint. A reduction of the heating setpoint to 0 °C or an increase of the cooling setpoint to 35 °C will stop the heating system.

Room Diff-NCT is valid between the different comfort times during the day. **Room Diff-Night** is valid between the last comfort time of the day and the first comfort time the next day.

Parameters

Name	Unit	Min	Max	Default	Description	Menu path
Room Temperature Setp	°C	0.0	50.0	-	Calculated room setpoint.	HSx ▶ Actual ▶
Supply Temperature Setp	°C	0.0	160.0	-	Calculated supply setpoint.	HSx ▶ Actual ▶
RoomSP-CT1	°C	0.0	50.0	21.0	Setpoint for Comfort Time 1.	HSx ▶ Setpoint ▶
RoomSP-CT2	°C	0.0	50.0	21.0	Setpoint for Comfort Time 2.	HSx ▶ Setpoint ▶
RoomSP-CT3	°C	0.0	50.0	21.0	Setpoint for Comfort Time 3.	HSx ▶ Setpoint ▶
RoomSP-CT4	°C	0.0	50.0	21.0	Setpoint for Comfort Time 4.	HSx ▶ Setpoint ▶
Room Diff-NCT	°C	0.0	50.0	5.0	NCT setpoint difference. Decreases the setpoint in heating mode, and increases the setpoint in cooling mode.	HSx ▶ Setpoint ▶

Name	Unit	Min	Max	Default	Description	Menu path
Room Diff-Night	°C	0.0	50.0	5.0	Night setpoint difference. Decreases the setpoint in heating mode, and increases the setpoint in cooling mode.	HSx ► Setpoint ►
Room Diff-Hol	°C	0.0	50.0	5.0	Holiday setpoint difference. Decreases the setpoint in heating mode, and increases the setpoint in cooling mode.	HSx ► Setpoint ►

3.2.3 Control curves / Setpoint

The control curve is used to calculate the supply / return setpoint and / or the demand for the heat producer. There are different kinds of control curves / setpoint calculations:

1. Constant setpoint
2. 8-point curve
3. DIN-curve with slope and exponent (only for heating mode)

Both curve types are outdoor temperature compensated curves.

Constant setpoint

If the setpoint type is set to constant, the setpoint is the same regardless of the outdoor temperature.

8-point curve

If the setpoint type is set to 8-point curve, the setpoint depends on the outdoor temperature by means of a control curve. At 8 settable outdoor temperatures, a corresponding supply temperature is entered.

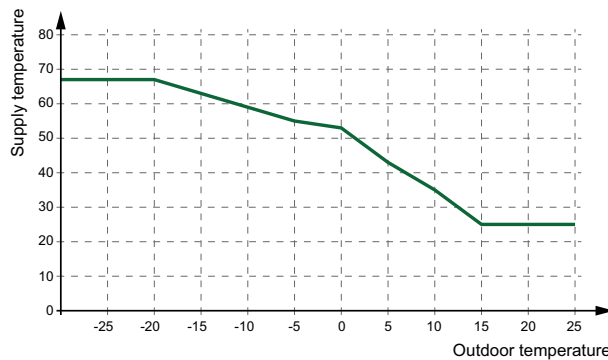

Figure 3-3 8-point curve

A displacement can be added to the 8-point control curve to move the entire curve up or down.

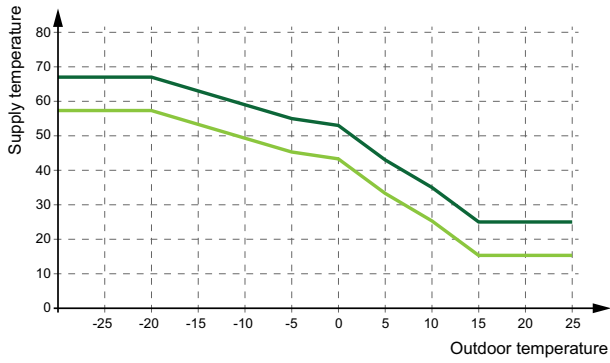

Figure 3-4 8-point curve with displacement

DIN-curve with slope and exponent

If the setpoint type is set to DIN-curve, the setpoint depends on the outdoor temperature by means of a control curve with settable slope and an exponent which bends the curve.

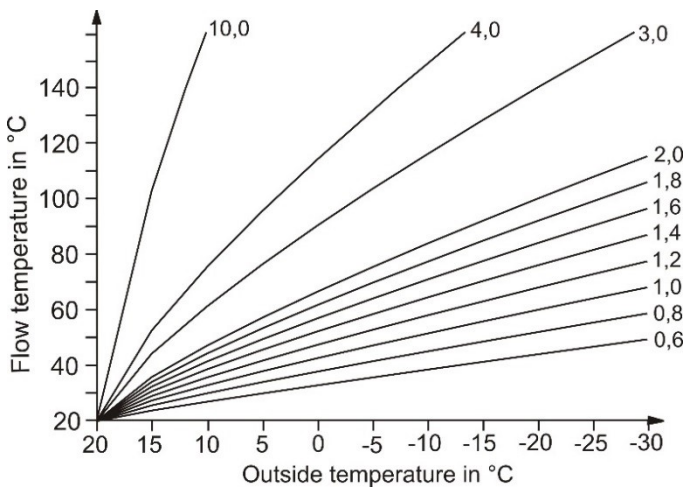

Figure 3-5 DIN-curve slope

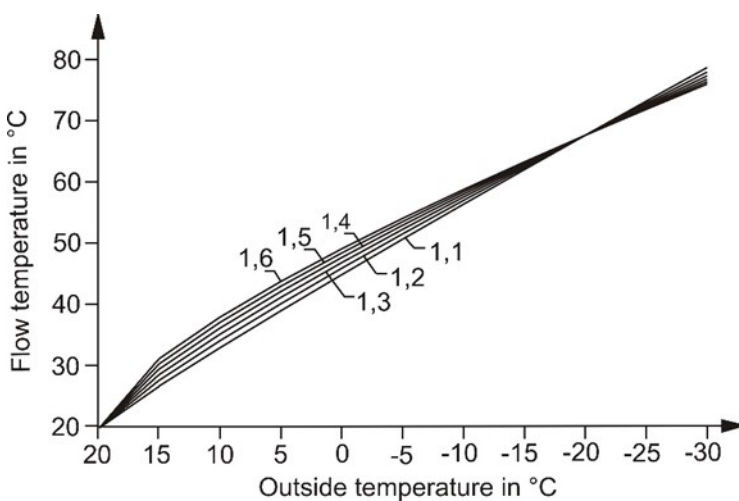

Figure 3-6 DIN-curve exponent

Some commonly used exponents are:

- ✓ 1.10 underfloor heating

- ✓ 1.20 radiators
- ✓ 1.33 DIN-radiators
- ✓ 1.25...1.40 plate radiators
- ✓ 1.40...1.60 convectors

Parameters

Name	Unit	Min	Max	Default	Description	Menu path
Heating Constant SetP	°C	2.0	90.0	45.0	Constant heating setpoint.	HSx ▶ Setpoint ▶
Heating Outd Comp Outdoor Temp 1	°C	-40.0	30.0	-20.0	Outdoor temperature 1 for 8–point heating curve.	HSx ▶ Setpoint ▶
Heating Outd Comp Outdoor Temp 2	°C	-40.0	30.0	-15.0	Outdoor temperature 2 for 8–point heating curve.	HSx ▶ Setpoint ▶
Heating Outd Comp Outdoor Temp 3	°C	-40.0	30.0	-10.0	Outdoor temperature 3 for 8–point heating curve.	HSx ▶ Setpoint ▶
Heating Outd Comp Outdoor Temp 4	°C	-40.0	30.0	-5.0	Outdoor temperature 4 for 8–point heating curve.	HSx ▶ Setpoint ▶
Heating Outd Comp Outdoor Temp 5	°C	-40.0	30.0	0.0	Outdoor temperature 5 for 8–point heating curve.	HSx ▶ Setpoint ▶
Heating Outd Comp Outdoor Temp 6	°C	-40.0	30.0	5.0	Outdoor temperature 6 for 8–point heating curve.	HSx ▶ Setpoint ▶
Heating Outd Comp Outdoor Temp 7	°C	-40.0	30.0	10.0	Outdoor temperature 7 for 8–point heating curve.	HSx ▶ Setpoint ▶
Heating Outd Comp Outdoor Temp 8	°C	-40.0	30.0	15.0	Outdoor temperature 8 for 8–point heating curve.	HSx ▶ Setpoint ▶
Heating Outd Comp Curve Output 1	°C	2.0	100.0	67.0	Value at outdoor temperature 1 for 8–point heating curve.	HSx ▶ Setpoint ▶
Heating Outd Comp Curve Output 2	°C	2.0	100.0	63.0	Value at outdoor temperature 2 for 8–point heating curve.	HSx ▶ Setpoint ▶
Heating Outd Comp Curve Output 3	°C	2.0	100.0	59.0	Value at outdoor temperature 3 for 8–point heating curve.	HSx ▶ Setpoint ▶
Heating Outd Comp Curve Output 4	°C	2.0	100.0	55.0	Value at outdoor temperature 4 for 8–point heating curve.	HSx ▶ Setpoint ▶
Heating Outd Comp Curve Output 5	°C	2.0	100.0	53.0	Value at outdoor temperature 5 for 8–point heating curve.	HSx ▶ Setpoint ▶
Heating Outd Comp Curve Output 6	°C	2.0	100.0	43.0	Value at outdoor temperature 6 for 8–point heating curve.	HSx ▶ Setpoint ▶
Heating Outd Comp Curve Output 7	°C	2.0	100.0	35.0	Value at outdoor temperature 7 for 8–point heating curve.	HSx ▶ Setpoint ▶
Heating Outd Comp Curve Output 8	°C	2.0	100.0	25.0	Value at outdoor temperature 8 for 8–point heating curve.	HSx ▶ Setpoint ▶
Heating Outd Comp Slope	-	0.1	10.0	1.4	DIN-curve slope.	HSx ▶ Setpoint ▶
Heating Outd Exponent	-	1.10	1.60	1.30	DIN-curve exponent.	HSx ▶ Setpoint ▶
Heating Manual Displacement	°C	-10.0	10.0	0.0	Manual displacement of the heating curve, only used for 8-point curve setpoint.	HSx ▶ Setpoint ▶
Supply Offset Heating	°C	-10.0	10.0	0.0	Offset for demand if the circuit is return temperature controlled.	Configuration ▶ HS ▶ System ▶ Return Temperature Control ▶
Cooling Constant SetP	°C	2.0	25.0	13.0	Constant cooling setpoint.	HSx ▶ Setpoint ▶
Cooling Outd Comp Outdoor Temp 1	°C	10.0	40.0	20.0	Outdoor temperature 1 for 8–point cooling curve.	HSx ▶ Setpoint ▶

Name	Unit	Min	Max	Default	Description	Menu path
Cooling Outd Comp Outdoor Temp 2	°C	10.0	40.0	22.0	Outdoor temperature 2 for 8–point cooling curve.	HSx ▶ Setpoint ▶
Cooling Outd Comp Outdoor Temp 3	°C	10.0	40.0	24.0	Outdoor temperature 3 for 8–point cooling curve.	HSx ▶ Setpoint ▶
Cooling Outd Comp Outdoor Temp 4	°C	10.0	40.0	26.0	Outdoor temperature 4 for 8–point cooling curve.	HSx ▶ Setpoint ▶
Cooling Outd Comp Outdoor Temp 5	°C	10.0	40.0	28.0	Outdoor temperature 5 for 8–point cooling curve.	HSx ▶ Setpoint ▶
Cooling Outd Comp Outdoor Temp 6	°C	10.0	40.0	30.0	Outdoor temperature 6 for 8–point cooling curve.	HSx ▶ Setpoint ▶
Cooling Outd Comp Outdoor Temp 7	°C	10.0	40.0	32.0	Outdoor temperature 7 for 8–point cooling curve.	HSx ▶ Setpoint ▶
Cooling Outd Comp Outdoor Temp 8	°C	10.0	40.0	34.0	Outdoor temperature 8 for 8–point cooling curve.	HSx ▶ Setpoint ▶
Cooling Outd Comp Curve Output 1	°C	2.0	25.0	15.0	Value at outdoor temperature 1 for 8–point cooling curve.	HSx ▶ Setpoint ▶
Cooling Outd Comp Curve Output 2	°C	2.0	25.0	14.0	Value at outdoor temperature 2 for 8–point cooling curve.	HSx ▶ Setpoint ▶
Cooling Outd Comp Curve Output 3	°C	2.0	25.0	13.0	Value at outdoor temperature 3 for 8–point cooling curve.	HSx ▶ Setpoint ▶
Cooling Outd Comp Curve Output 4	°C	2.0	25.0	12.0	Value at outdoor temperature 4 for 8–point cooling curve.	HSx ▶ Setpoint ▶
Cooling Outd Comp Curve Output 5	°C	2.0	25.0	12.0	Value at outdoor temperature 5 for 8–point cooling curve.	HSx ▶ Setpoint ▶
Cooling Outd Comp Curve Output 6	°C	2.0	25.0	11.0	Value at outdoor temperature 6 for 8–point cooling curve.	HSx ▶ Setpoint ▶
Cooling Outd Comp Curve Output 7	°C	2.0	25.0	10.0	Value at outdoor temperature 7 for 8–point cooling curve.	HSx ▶ Setpoint ▶
Cooling Outd Comp Curve Output 8	°C	2.0	25.0	9.0	Value at outdoor temperature 8 for 8–point cooling curve.	HSx ▶ Setpoint ▶
Cooling Manual Displacement	°C	-10.0	10.0	0.0	Manual displacement of the cooling curve, only used for 8-point curve setpoint.	HSx ▶ Setpoint ▶
Supply Offset Cooling	°C	0.0	20.0	5.0	Offset for demand if the circuit is return temperature controlled.	Configuration ▶ HS ▶ System ▶ Return Temperature Control ▶

3.2.4 General settings / Configuration

Depending on the **Control type**, the heating system can work as a heating circuit, a cooling circuit or change between both. If the **Control type** is set to *ChangeOver*, the circuit changes to cooling if the outdoor temperature exceeds the limit **Change Over Cooling** or if the input **ChangeOver** is set to 1 (Cooling). The circuit changes back to heating if the outdoor temperature is falling below the limit **Change Over Heating** and the input **ChangeOver** is set to 0 (Auto). If the input **CoolStart** is configured, the circuit can start to cool if the input is 1 and start to heat if the input is 0. If there is a supply sensor and a return sensor configured, the system can control the return temperature instead of the supply temperature by setting the parameter **Return Temperature Control** to 1.

Parameters

Name	Unit	Min	Max	Default	Description	Menu path
Control type	-	0	2	0	0 = Heating 1 = Cooling 2 = Change Over	Configuration ► HS ► HSx ► System ►
Change Over Heating	°C	10	50	17	If the outdoor temperature is lower than Change Over Heating , the circuit changes to heating mode.	Configuration ► HS ► HSx ► System ► Control Type ►
Change Over Cooling	°C	10	50	24	If the outdoor temperature is higher than Change Over Cooling the circuit changes to cooling mode.	Configuration ► HS ► HSx ► System ► Control Type ►
Return Temperature Control	-	0	1	0	The system controls the return temperature instead of the supply temperature when set to 1.	Configuration ► HS ► HSx ► System ►
Type of Heating Setpoint	-	0	2	1	0 = Constant 1 = 8-point curve 2 = DIN-curve	Configuration ► HS ► HSx ► System ►
Type of Cooling Setpoint	-	0	1	0	0 = Constant 1 = 8-point curve	Configuration ► HS ► HSx ► System ►
Design Temp	°C	-40	10	-12	If the outdoor temperature is lower than the design temperature, night setback is stopped.	HSx ► Setpoint ►
Max supply temperature	°C	0	100	100	The maximum supply temperature.	Configuration ► HS ► Alarm settings ► Alarm Limits ►
Pump Type	-	0	1	0	Type of pump. 0 = Single pump 1 = Double pump	Configuration ► HS ► HSx ► System ►
Pump Ind	-	0	1	0	Type of feedback for the pump. 0 = motor protection 1 = run indication	Configuration ► HS ► HSx ► System ►
Pump Delay	s	0	200	10	Delay time of the pump indication.	Configuration ► HS ► HSx ► System ►
Pump Runtime	h	0	1000	100	Runtime of the pump, only used for double pumps.	Configuration ► HS ► HSx ► System ►
Actuator Type Valve	-	1	4	1	Type of actuator 1 = 0-10 V 2 = 2-10 V 3 = 10-2 V 4 = 10-0 V	Configuration ► HS ► HSx ► System ►
Actuator Runtime	s	0	600	120	Runtime of the actuator of the control valve.	Configuration ► HS ► HSx ► System ►
Actuator Runtime Heat->Cool	s	0	600	120	Runtime of the actuator that is used to switch between heating and cooling.	Configuration ► HS ► HSx ► System ►

3.2.5 Temperature control

This menu shows all parameters necessary for the configuration of the PI controller of the heating circuit.

Parameters

Name	Unit	Min	Max	Default	Description	Menu path
Heating P-band	°C	1	1000	100	P-band heating.	HSx ► Temp control ►
Heating I-time	s	0	9999	100	I-time heating.	HSx ► Temp control ►
Heating Output	%	0	100	-	Controller output.	HSx ► Temp control ►

Name	Unit	Min	Max	Default	Description	Menu path
Cooling P-band	°C	1	1000	20	P-band cooling.	HSx ▶ Temp control ▶
Cooling I-time	s	0	9999	60	I-time cooling.	HSx ▶ Temp control ▶
Cooling Output	%	0	100	-	Controller output.	HSx ▶ Temp control ▶

3.2.6 Frost protection

In order to prevent damage to the heating circuit, the Frost protection function is always active (unless the controller is in *Non-active* or *Manual* mode). There are three different parameters that can make the circuit change to frost mode.

- ✓ **Frost Limit Outdoor:** This parameter permits setting the outdoor temperature at which the pump of the heating circuit will be started. The water in the pipes is kept in motion even if the heating circuit does not require any heat, thereby preventing freezing. This should prevent freezing of pipes running at the outdoor wall of the building. The frost protection mode stops when the outdoor temperature is 1 K above the limit.
- ✓ **Frost Limit Supply:** This parameter permits setting the supply temperature at which the circuit changes to frost protection mode. The frost protection mode stops when the supply temperature is 10 K above the limit.
- ✓ **Frost Limit Room:** This parameter permits setting the room temperature at which the circuit changes to frost protection mode. The frost protection mode stops when the room temperature is 1 K above the limit.

During frost protection mode (activated by **Frost Limit Supply** or **Frost Limit Room**), the setpoint and the heat demand is set to the maximum setpoint.

Parameters

Name	Unit	Min	Max	Default	Description	Menu path
Frost Limit Supply	°C	-30.0	50.0	5.0	The supply temperature at which the circuit changes to frost protection mode.	Configuration ▶ HS ▶ HSx ▶ Frost ▶
Frost Limit Room	°C	-30.0	50.0	5.0	The room temperature at which the circuit changes to frost protection mode.	Configuration ▶ HS ▶ HSx ▶ Frost ▶
Frost Limit Outdoor	°C	-30.0	50.0	2.0	The outdoor temperature at which the pump of the heating circuit will be started.	Configuration ▶ HS ▶ HSx ▶ Frost ▶

3.2.7 Shutdown / Pumpstop

The *Shutdown/Pumpstop* function performs the same function that a building caretaker would perform; monitoring outdoor temperature and switching the heating circuit off. There are different temperatures for day and night. The night temperatures are valid if the timer of the heating system is in Eco- or holiday-mode. The start and stop of the system can be delayed by the parameters **Degree minutes stop** and **Degree minutes start**. With the parameters **Stop date** and **Start date** it is possible to define a heating season/period or a cooling season/period. When in shut-off-mode, the function only attempts to protect the building by preventing clogging or blocking of pumps and valves and watching for frost.

Parameters

Name	Unit	Min	Max	Default	Description	Menu path
Mode	-	0	1	1	Turns the <i>Pump stop</i> function on or off. 0 = Off 1 = On	Configuration ► HS ► HSx ► Shutdown/ Pumpstop ►
Shut Off Heating Day Temp	°C	0	50	17	Outdoor temperature to shut off heating mode during day (within comfort times).	Configuration ► HS ► HSx ► Shutdown/ Pumpstop ►
Shut Off Heating Night Temp	°C	0	50	15	Outdoor temperature to shut off heating mode during night (outside of comfort times).	Configuration ► HS ► HSx ► Shutdown/ Pumpstop ►
Shut Off Cooling Day Temp	°C	0	50	20	Outdoor temperature to shut off cooling mode during day (within comfort times).	Configuration ► HS ► HSx ► Shutdown/ Pumpstop ►
Shut Off Cooling Night Temp	°C	0	50	22	Outdoor temperature to shut off cooling mode during night (outside of comfort times).	Configuration ► HS ► HSx ► Shutdown/ Pumpstop ►
Hysteresis	°C	0	20	2	Hysteresis of the Shut Off temperature.	Configuration ► HS ► HSx ► Shutdown/ Pumpstop ►
Degree minutes Stop	°Cmin	0	1000	0		Configuration ► HS ► HSx ► Shutdown/ Pumpstop ►
Degree minutes Start	°Cmin	0	1000	0		Configuration ► HS ► HSx ► Shutdown/ Pumpstop ►
Stop date heating	-	00.00	31.12	00.00		Configuration ► HS ► HSx ► Shutdown/ Pumpstop ►
Start date heating	-	00.00	31.12	00.00		Configuration ► HS ► HSx ► Shutdown/ Pumpstop ►
Stop date cooling	-	00.00	31.12	00.00		Configuration ► HS ► HSx ► Shutdown/ Pumpstop ►
Start date cooling	-	00.00	31.12	00.00		Configuration ► HS ► HSx ► Shutdown/ Pumpstop ►
Switch Off Delay	min	0	60	1	Switch off delay of the pump.	Configuration ► HS ► HSx ► Pump Control ►

3.2.8 Optimizer / Boost

The *Optimizer* function is used in order to reach the set room temperature when comfort time is activated after a period of night set-back. How far in advance the supply temperature is to be increased is calculated as below:

$$\text{Optimization time} = (\text{Setpoint Room} - \text{Actual value Room}) / \text{Heating capacity}$$

The heating capacity has a minimum and a maximum value (default minimum value is 0.02°C/min, maximum value is 0.1°C/min). The average of the min. and max. capacities is used as the start value for the function. Then the capacity is converted as below:

$$\text{Heating capacity} = (\text{Heating capacity} + \text{Temperature boost} / \text{Optimization time}) / 2$$

Here, the temperature boost is equal to the difference in room temperature when the optimization was stopped and when it was started.

When outdoor compensation of the start time optimization is active, the compensated capacity is calculated as below:

$$\text{Outdoor compensated capacity} = \text{capacity} * (1 + \text{Outdoor compensation} / 100 * \text{Outdoor temperature diff})$$

The outdoor compensation is a settable percentage between 0...100 % (0 % = no compensation). The factory setting is 3 %.

Outdoor temperature diff is the difference between the actual outdoor temperature and the outdoor temperature at the latest optimization. This function is used in order to reach the set room temperature when comfort time is activated after a period of night set-back.

Boost: Boost is used to speed up the raising of the indoor temperature when switching from night set back temperature to normal comfort temperature. This is done by temporarily displacing the supply temperature setpoint curve. The following conditions must be met:

- ✓ Average outdoor temperature must be lower than 17°C
- ✓ Supply set-point value must be higher than 25°C
- ✓ Night set-back must be more than 2°C (room temperature)

Parameters

Name	Unit	Min	Max	Default	Description	Menu path
Mode	-	0	1	1	Turns the <i>Optimizer</i> function on or off. 0 = Off 1 = On	Configuration ▶ HS ▶ HSx ▶ Optimizer ▶
Heating Capacity Min	°C/min	0.02	0.1	0.02	Minimum heating capacity, see the function description above.	Configuration ▶ HS ▶ HSx ▶ Optimizer ▶
Heating Capacity Max	°C/min	0.02	0.1	0.1	Maximum heating capacity, see the function description above.	Configuration ▶ HS ▶ HSx ▶ Optimizer ▶
Outdoor Compensating Factor	%	0	100	3	Compensating factor, see the formula above.	Configuration ▶ HS ▶ HSx ▶ Optimizer ▶
Boost Factor	h	0.0	10.0	0.0	How long time the heating system will increase the demand to heat up faster.	Configuration ▶ HS ▶ HSx ▶ Optimizer ▶
Start Optimizer Time Until Start	min	0	1440	-	Calculated time until start.	HSx ▶ Actual ▶

3.2.9 Delayed outdoor / Room temperature

Every building has the capacity to store energy. The amount of energy that a building can store is described in the **Building inertia** parameter. This value is dependent on the construction of the building (e.g. the thickness of its outdoor walls, insulation, type of windows, etc.).

If **Building inertia** is activated (value > 0), the outdoor temperature will be delayed by this value. The delayed outdoor temperature will then be used instead of the real value.

The parameter **Mode** defines how the delayed outdoor temperature will be calculated. **Mode** = 0 means that the function is not active, **Mode** = 1 means that the temperature will be delayed all the time and **Mode** = 2 means that the temperature will be delayed on falling temperatures and not delayed on rising temperatures.

If a room sensor is configured, the measured value at the sensor can be delayed by the value of **Average**. If no room sensor is configured but the building inertia is activated, a virtual room temperature will be calculated.

The calculation of the virtual room temperature is depending on the latest room setpoint, the outdoor temperature and the building inertia and simulates the natural cool down of a building.

Parameters

Name	Unit	Min	Max	Default	Description	Menu path
Mode	-	0	2	0	Defines how the delayed outdoor temperature will be calculated.	
Building inertia	h	0.0	24.0	0.0	Delay of the outdoor temperature.	Configuration ► General Functions ► Heating ►
Average	Min	0.0	60.0	5.0	Delay of the measured room temperature.	Configuration ► HS ► HSx ► Room average ►

3.2.10 Remote control unit

The *Remote control unit* function permits configuring the influence of the remote control unit. If the remote control unit is equipped with a setpoint potentiometer, the signal of the potentiometer can be connected to the analogue inputs **Extra Sensor 1 - 5**.

If the remote control unit is equipped with a button, the button can be used to extend the day-mode or insert a day-period with the length of **Extended Run**.

Parameters

Name	Unit	Min	Max	Default	Description	Menu path
Mode	-	0	5	0	Turns the <i>Remote control unit</i> function on or off. 0 = Off 1 = Extra sensor 1 2 = Extra sensor 2 3 = Extra sensor 3 4 = Extra sensor 4 5 = Extra sensor 5	Configuration ► HS ► HSx ► Remote control ►
Extended Run	min	0.0	600.0	120.0	Extended run-time.	HSx ► Actual ►

3.2.11 Support operation

If a room temperature sensor is configured or a virtual room temperature is calculated, the additional function *Support operation* can be used to switch off the pump and close the valve during non-comfort time until the NCT setpoint is reached. Then the controller starts and controls the non-comfort setpoint.

Parameters

Name	Unit	Min	Max	Default	Description	Menu path
Support Operation Active	-	0	1	0	Turns the <i>Support operation</i> function on or off. 0 = Off 1 = On	Configuration ► HS ► HSx ► Support operation ►

3.2.12 Flash adaption

The *Flash adaption* function switches off the heating as soon as the room temperature exceeds the setpoint by the settable **Limit** parameter.

Heating starts again if the room temperature is lower than switch-off point minus 1°C.

Parameters

Name	Unit	Min	Max	Default	Description	Menu path
Mode	-	0	1	0	Turns the <i>Flash adaption</i> function on or off. 0 = Off 1 = On	Configuration ► HS ► HSx ► Flash adaption ►
Limit	°C	0	10	2	The <i>Flash adaption</i> function switches off the heating as soon as the room temperature exceeds the setpoint by this amount.	Configuration ► HS ► HSx ► Flash adaption ►

3.2.13 Wind compensation

The *Wind compensation* function can generate a setpoint displacement to compensate for wind chilling if a wind sensor is connected. The function has a settable displacement factor (°C per m/s).

Parameters

Name	Unit	Min	Max	Default	Description	Menu path
Mode	-	0	1	0	Turns the <i>Wind compensation</i> function on or off. 0 = Off 1 = On	Configuration ► HS ► HSx ► Wind compensation ►
Displacement	°C/(m/s)	0.0	2.0	0.1	Displacement factor to compensate for wind.	Configuration ► HS ► HSx ► Wind compensation ►

3.2.14 Room compensation

If the *Room compensation* function is activated, the calculated setpoint or demand is corrected by means of a PI controller according to the control deviation in the room.

Parameters

Name	Unit	Min	Max	Default	Description	Menu path
Mode	-	0	1	0	Turns the <i>Room compensation</i> function on or off. 0 = Off 1 = On	Configuration ► HS ► HSx ► Room compensation ►
Heat Max Pos Corr	°C	0.0	100.0	20.0	Max. positive correction of the setpoint in heating mode.	Configuration ► HS ► HSx ► Room compensation ►
Heat Max Neg Corr	°C	-100.0	0.0	-20.0	Max. negative correction of the setpoint in heating mode.	Configuration ► HS ► HSx ► Room compensation ►
Cool Max Pos Corr	°C	0.0	100.0	5.0	Max. positive correction of the setpoint in cooling mode.	Configuration ► HS ► HSx ► Room compensation ►
Cool Max Neg Corr	°C	-100.0	0.0	-5.0	Max. negative correction of the setpoint in cooling mode.	Configuration ► HS ► HSx ► Room compensation ►
Room Comp Heating P-Band	°C	1	100	100	P-band of heating mode.	HSx ► Temp control ►
Room Comp Heating I-time	s	0	9999	0	I-time of heating mode.	HSx ► Temp control ►
Room Comp Heating Output	°C	-	-	-	Controller output.	HSx ► Temp control ►

Name	Unit	Min	Max	Default	Description	Menu path
Room Comp Cooling P-Band	°C	1	100	100	P-band of cooling mode.	HSx ▶ Temp control ▶
Room Comp Cooling I-time	s	0	9999	0	I-time of cooling mode.	HSx ▶ Temp control ▶
Room Comp Cooling Output	°C	-	-	-	Controller output.	HSx ▶ Temp control ▶

3.2.15 Temperature limitation

The heating systems have individually settable min. and max. temperature limits on the supply and return. There are different settings for heating and cooling.

If control of supply temperature is selected and the return temperature is not within the set limits, the supply setpoint will be adjusted with a settable limitation factor (**Return Lim. Heating Scale** or **Return Lim. Cooling Scale**) to eliminate the error. However, the supply setpoint will never fall below/exceed the set min./max. setpoint.

If control of return temperature is selected, the supply temperature will be limited by adjusting the return setpoint.

The displacement minimum limitation is calculated according to:

$$\text{Displacement} = (\text{Min Limit} - \text{temperature}) * \text{Limitation factor}$$

This displacement can only provide a positive displacement; otherwise the displacement will be 0.

The displacement maximum limitation is calculated according to:

$$\text{Displacement} = (\text{Max Limit} - \text{temperature}) * \text{Limitation factor}$$

This displacement can only provide a negative displacement; otherwise the displacement will be 0.

Primary and secondary return temperature limits

The primary return temperature must not be more than 3 degrees (settable parameter **Max Delta-T**) higher than the secondary return temperature. When the difference exceeds this value, the control signal to the valve will be overridden to close the valve, i.e. decrease the flow, which will lower the return temperature.

Parameters, Return limitation heating

Name	Unit	Min	Max	Default	Description	Menu path
Min Return Lim. Heating Mode	-	0	1	0	Activates return limitation at the min. temperature limit for heating mode.	Configuration ▶ HS ▶ HSx ▶ Temperature limit. ▶
Min Return Lim. Heating Limit	°C	2.0	160.0	2.0		Configuration ▶ HS ▶ HSx ▶ Temperature limit. ▶
Max Return Lim. Heating Mode	-	0	1	0	Activates return limitation at the max. temperature limit for heating mode.	Configuration ▶ HS ▶ HSx ▶ Temperature limit. ▶
Max Return Lim. Heating Limit	°C	2.0	160.0	160.0		Configuration ▶ HS ▶ HSx ▶ Temperature limit. ▶
Return Lim. Heating Scale	-	0.0	10.0	1.0		Configuration ▶ HS ▶ HSx ▶ Temperature limit. ▶

Parameters, Supply limitation heating

Name	Unit	Min	Max	Default	Description	Menu path
Min Supply Lim. Heating Mode	-	0	1	0	Activates supply limitation at the min. temperature limit for heating mode.	Configuration ► HS ► HSx ► Temperature limit. ►
Min Supply Lim. Heating Limit	°C	2.0	160.0	2.0		Configuration ► HS ► HSx ► Temperature limit. ►
Max Supply Lim. Heating Mode	-	0	1	0	Activates supply limitation at the max. temperature limit for heating mode.	Configuration ► HS ► HSx ► Temperature limit. ►
Max Supply Lim. Heating Limit	°C	2.0	160.0	160.0		Configuration ► HS ► HSx ► Temperature limit. ►
Supply Lim. Heating Scale	°C	0.0	10.0	1.0		Configuration ► HS ► HSx ► Temperature limit. ►

Parameters, Return limitation cooling

Name	Unit	Min	Max	Default	Description	Menu path
Min Return Lim. Cooling Mode	-	0	1	0	Activates return limitation at the min. temperature limit for cooling mode.	Configuration ► HS ► HSx ► Temperature limit. ►
Min Return Lim. Cooling Limit	°C	2.0	160.0	2.0		Configuration ► HS ► HSx ► Temperature limit. ►
Max Return Lim. Cooling Mode	-	0	1	0	Activates return limitation at the max. temperature limit for cooling mode.	Configuration ► HS ► HSx ► Temperature limit. ►
Max Return Lim. Cooling Limit	°C	2.0	160.0	160.0		Configuration ► HS ► HSx ► Temperature limit. ►
Return Lim. Cooling Scale	°C	0.0	10.0	1.0		Configuration ► HS ► HSx ► Temperature limit. ►

Parameters, Supply limitation cooling

Name	Unit	Min	Max	Default	Description	Menu path
Min Supply Lim. Cooling Mode	-	0	1	0	Activates supply limitation at the min. temperature limit for cooling mode.	Configuration ► HS ► HSx ► Temperature limit. ►
Min Supply Lim. Cooling Limit	°C	2.0	160.0	2.0		Configuration ► HS ► HSx ► Temperature limit. ►
Max Supply Lim. Cooling Mode	-	0	1	0	Activates supply limitation at the max. temperature limit for cooling mode.	Configuration ► HS ► HSx ► Temperature limit. ►
Max Supply Lim. Cooling Limit	°C	2.0	160.0	160.0		Configuration ► HS ► HSx ► Temperature limit. ►
Supply Lim. Cooling Scale	-	0.0	10.0	1.0		Configuration ► HS ► HSx ► Temperature limit. ►

Parameters, Setpoint limitation

Name	Unit	Min	Max	Default	Description	Menu path
Minimum Setp	°C	2.0	160.0	2.0		Configuration ► HS ► HSx ► Temperature limit. ►
Maximum Setp	°C	2.0	160.0	80.0		Configuration ► HS ► HSx ► Temperature limit. ►

Parameters, Delta-T control

Name	Unit	Min	Max	Default	Description	Menu path
Mode	-	0	1	0	Activation of Delta-T control.	Configuration ► HS ► HSx ► Temperature limit. ►
Max Delta-T	°C	0.0	100.0	3.0	Max. difference between HP-return and HSx-return sensor.	Configuration ► HS ► HSx ► Temperature limit. ►
Return Temp P-Band	°C	1	1000	100	P-band.	HSx ► Temp control ►
Return Temp I-Time	s	0	9999	100	I-time.	HSx ► Temp control ►
Return Temp Output	%	0	100	-	Controller output.	HSx ► Temp control ►

3.2.16 Power limitation

The *Power limitation* function permits limitation of the capacity output to the heating circuit. This function requires a heat meter to be installed and connected, providing the currently used capacity. Limitation affects the signal to the valve of the heating circuit.

Parameters

Name	Unit	Min	Max	Default	Description	Menu path
Type of limit	-	0	1	0	0 = constant 1 = curve	Configuration ► HS ► HSx ► Power limitation ►
Limit	kW	0	10000	10000	Max. limit of the consumed heat capacity. Used when Type of limit is set to constant.	Configuration ► HS ► HSx ► Power limitation ►
Outdoor Temp 1	°C	-40.0	30.0	-20.0	Used when Type of limit is set to curve.	Configuration ► HS ► HSx ► Power limitation ►
Outdoor Temp 2	°C	-40.0	30.0	-15.0	Used when Type of limit is set to curve.	Configuration ► HS ► HSx ► Power limitation ►
Outdoor Temp 3	°C	-40.0	30.0	-10.0	Used when Type of limit is set to curve.	Configuration ► HS ► HSx ► Power limitation ►
Outdoor Temp 4	°C	-40.0	30.0	-5.0	Used when Type of limit is set to curve.	Configuration ► HS ► HSx ► Power limitation ►
Outdoor Temp 5	°C	-40.0	30.0	0.0	Used when Type of limit is set to curve.	Configuration ► HS ► HSx ► Power limitation ►
Outdoor Temp 6	°C	-40.0	30.0	5.0	Used when Type of limit is set to curve.	Configuration ► HS ► HSx ► Power limitation ►
Outdoor Temp 7	°C	-40.0	30.0	10.0	Used when Type of limit is set to curve.	Configuration ► HS ► HSx ► Power limitation ►

Name	Unit	Min	Max	Default	Description	Menu path
Outdoor Temp 8	°C	-40.0	30.0	15.0	Used when Type of limit is set to curve.	Configuration ▶ HS ▶ HSx ▶ Power limitation ▶
Limit output 1	kW	0.0	10000.-0	10000.-0	Used when Type of limit is set to curve.	Configuration ▶ HS ▶ HSx ▶ Power limitation ▶
Limit output 2	kW	0.0	10000.-0	10000.-0	Used when Type of limit is set to curve.	Configuration ▶ HS ▶ HSx ▶ Power limitation ▶
Limit output 3	kW	0.0	10000.-0	10000.-0	Used when Type of limit is set to curve.	Configuration ▶ HS ▶ HSx ▶ Power limitation ▶
Limit output 4	kW	0.0	10000.-0	10000.-0	Used when Type of limit is set to curve.	Configuration ▶ HS ▶ HSx ▶ Power limitation ▶
Limit output 5	kW	0.0	10000.-0	10000.-0	Used when Type of limit is set to curve.	Configuration ▶ HS ▶ HSx ▶ Power limitation ▶
Limit output 6	kW	0.0	10000.-0	10000.-0	Used when Type of limit is set to curve.	Configuration ▶ HS ▶ HSx ▶ Power limitation ▶
Limit output 7	kW	0.0	10000.-0	10000.-0	Used when Type of limit is set to curve.	Configuration ▶ HS ▶ HSx ▶ Power limitation ▶
Limit output 8	kW	0.0	10000.-0	10000.-0	Used when Type of limit is set to curve.	Configuration ▶ HS ▶ HSx ▶ Power limitation ▶
Power Limit P-Band	kW	1	1000	100	P-band.	HSx ▶ Temp control ▶
Power Limit I-Time	s	0	9999	100	I-time.	HSx ▶ Temp control ▶
Power Limit Output	%	0	100	-	Controller output.	HSx ▶ Temp control ▶

3.2.17 Dew point / Dehumidification

Dew point control is used in order to avoid condensation in the cooling pipe system, especially when chilled beams are connected. The *Dew point* function increases the supply temperature setpoint of the cooling circuit depending on the present dew point in the room. A combined humidity and temperature transmitter must be connected and configured.

The function calculates the actual dew point temperature and adds it to a settable setpoint displacement (default 1°C). Then the sum is compared with the present setpoint. The highest value will be used as supply temperature setpoint for the cooling system.

The *Dehumidification* function controls the **Dehumidifier** output depending on the humidity in the room.

It has two different operation modes; constant or calculated setpoint.

- ✓ Constant setpoint: **Dehumidifier** is switched on if the humidity is higher than the setpoint and switched off if the humidity is lower than setpoint – hysteresis.
- ✓ Calculated setpoint: **Dehumidifier** is switched on if the dew point temperature is higher than supply temperature – hysteresis and switched off if the dew point temperature is lower than supply temperature – hysteresis – 1K.

The function can be set to work permanently or depending on the time schedule.

Parameters, Dew point

Name	Unit	Min	Max	Default	Description	Menu path
Mode	-	0	1	0	Turns the <i>Dew point</i> function on or off. 0 = Off 1 = On	Configuration ► HS ► HSx ► Dewpoint control ►
SetP Offset	°C	0	10.0	1	The difference between dew point temperature and supply temperature.	Configuration ► HS ► HSx ► Dewpoint control ►
Min SetP	°C	0	100.0	0	Min limitation of setpoint.	Configuration ► HS ► HSx ► Dewpoint control ►
Max SetP	°C	0.1	100.0	100.0	Max limitation of setpoint.	Configuration ► HS ► HSx ► Dewpoint control ►

Parameters, Dehumidifier

Name	Unit	Min	Max	Default	Description	Menu path
Mode	-	0	2	0	Turns the <i>Dehumidification</i> function on, off or time program controlled. 0 = Off 1 = Always on 2 = Time program controlled	Configuration ► HS ► HSx ► Dehumidification ►
Type of Setpont	-	0	1	0	0 = Constant 1 = Calculated	Configuration ► HS ► HSx ► Dehumidification ►
Dehumidification SetP	%RH	0	100	55	Only used for constant setpoint.	HSx ► Setpoint ►
Start Diff	°C	0.0	100.0	1.0	Start difference, only used for calculated setpoint.	Configuration ► HS ► HSx ► Dehumidification ►
Stop Hyst	%RH	0.0	100.0	2.5	Stop hysteresis, only used for constant setpoint.	Configuration ► HS ► HSx ► Dehumidification ►

3.2.18 Heating degrees

The *Heating degrees* function is used to calculate the heating degrees of the current year and store the historical value of the last year.

Heating degrees is the accumulated difference of the mean room temperature of 20°C and the daily average of the outdoor temperature at all days with heating demand.

Parameters

Name	Unit	Min	Max	Default	Description	Menu path
Heating degrees Act	h	0	10000	-	Current heating degrees	Configuration ► HS ► HSx ► Actual ►
Heating degrees Last year	h	0	10000-	-	Heating degrees last year	Configuration ► HS ► HSx ► Actual ►

3.2.19 Universal limitation

The *Universal limitation* function requires a limitation sensor to be configured.

Depending on the type of limitation, the function can be used optionally for maximum or minimum limitation and the actuator can either open or close in case of limit violation.

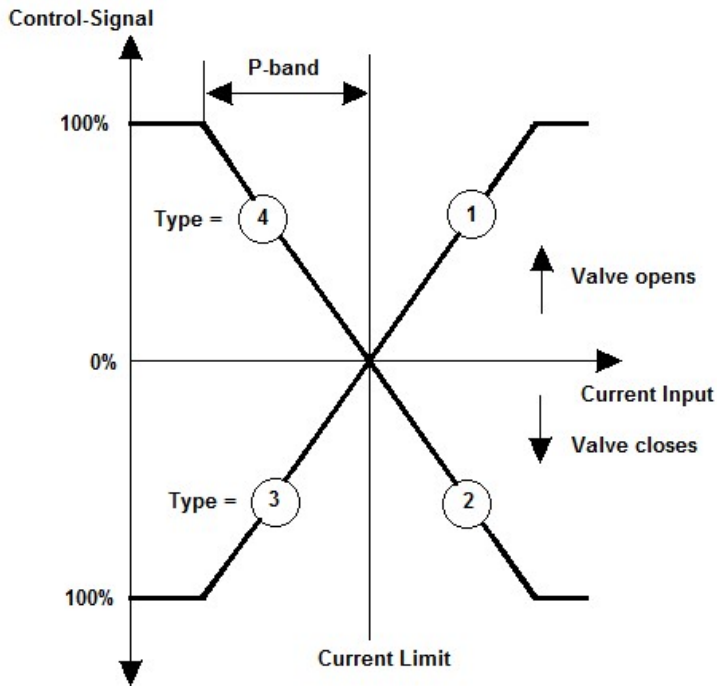

Figure 3-7 Universal limitation

Type 1: Maximum limitation, open valve.

Type 2: Maximum limitation, close valve.

Type 3: Minimum limitation, close valve.

Type 4: Minimum limitation, open valve.

The limit can be defined as fixed value or as shifting value with a variable shifting curve according to the value of the shift sensor.

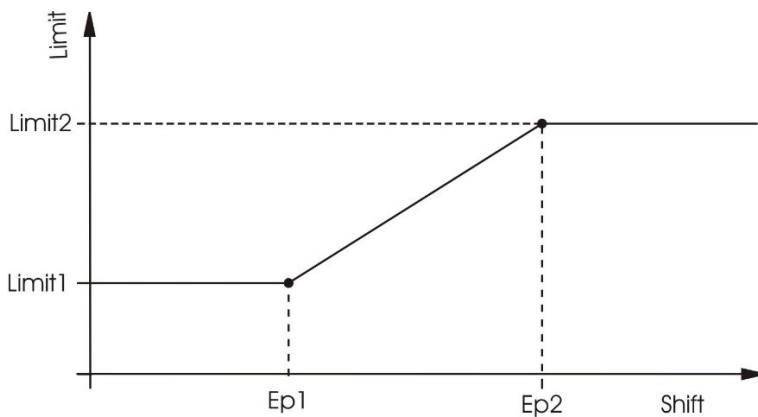

Figure 3-8 Variable shifting curve

Parameters

Name	Unit	Min	Max	Default	Description	Menu path
Active	-	0	1	1	Turns the <i>Universal limitation</i> function on or off. 0 = Off 1 = On	Configuration ► HS ► HSx ► Universal limit. ►
Type	-	1	4	2	1 = Max limitation, open valve 2 = Max limitation, close valve 3 = Min limitation, close valve 4 = Min limitation, open valve	Configuration ► HS ► HSx ► Universal limit. ►
Shift	-	0	1	0	Limit defined as a shifting value (shift sensor required)	Configuration ► HS ► HSx ► Universal limit. ►
Limit1	°C	2.0	160.0	80.0	The limit at Entry point 1 .	Configuration ► HS ► HSx ► Universal limit. ►
EntryPoint1	°C	-50.0	50.0	0.0	Point 1 of the shift curve.	Configuration ► HS ► HSx ► Universal limit. ►
Limit2	°C	2.0	160.0	60.0	The limit at Entry point 2 .	Configuration ► HS ► HSx ► Universal limit. ►
EntryPoint2	°C	-50.0	50.0	20.0	Point 2 of the shift curve.	Configuration ► HS ► HSx ► Universal limit. ►
Universal Limit P-Band	°C	1	1000	100	P-band.	HSx ► Temp control ►
Universal Limit I-Time	s	0	9999	60	I-time.	HSx ► Temp control ►
Universal Limit Output	%	0	100	-	The calculated signal to the valve.	HSx ► Temp control ►
Universal Limit Setp	°C	2.0	160.0	-	The calculated limit.	HSx ► Actual ►

3.2.20 Bypass

In a cooling system, a digital output can be used to control a bypass valve. The conditions for the bypass valve to open are for the outdoor temperature to fall below 3°C and for the control valve to be closed (0 %). The bypass valve closes if the outdoor temperature is higher than 5°C or the control valve opens.

3.2.21 Screed drying

The *Screed drying* function is used in order to support the drying of concrete floors in which an underfloor heating system is installed. The function influences the supply temperature to optimize drying time and prevent the possibility of cracks in the floor.

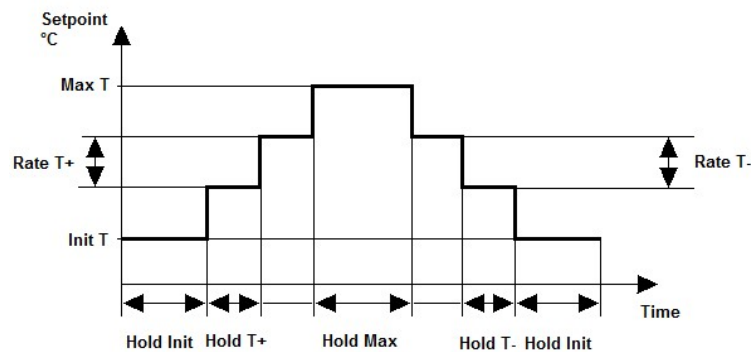

Figure 3-9 Screed drying

Parameters

Name	Unit	Min	Max	Default	Description	Menu path
Mode	-	1	1	0	Turns the <i>Screed drying</i> function on or off. 0 = Off 1 = On	Configuration ► HS ► HSx ► Screed Drying ►
Init Temp	°C	2.0	80.0	25.0	The supply temperature with which the screed drying phase will start.	Configuration ► HS ► HSx ► Screed Drying ►
Hold Init Temp	days	0	10	1	The duration that the controller will hold the Init Temp .	Configuration ► HS ► HSx ► Screed Drying ►
Rate Temp +	°C	1.0	80.0	5.0	The increase of the supply temperature after Time+ .	Configuration ► HS ► HSx ► Screed Drying ►
Time+	days	1	50	1	The duration the controller will hold the temperature of the heat-up period.	Configuration ► HS ► HSx ► Screed Drying ►
Max Temp	°C	2.0	80.0	45.0	The maximum supply temperature during the phase.	Configuration ► HS ► HSx ► Screed Drying ►
Time Max	days	0	10	3	The time, during which the controller will hold the Max Temp , after which the temperature will slowly decrease.	Configuration ► HS ► HSx ► Screed Drying ►
Rate Temp -	°C	1.0	80.0	5.0	The decrease of the supply temperature after Time- .	Configuration ► HS ► HSx ► Screed Drying ►
Time-	days	1	50	1	The duration the controller will hold the temperature of the cool-down period.	Configuration ► HS ► HSx ► Screed Drying ►
Opt Power Fail	-	2	2	0	This parameter permits establishing how the controller should react if a power failure occurs during the screed drying period: 0: Restart current step 1: Restart completely 2: Stop	Configuration ► HS ► HSx ► Screed Drying ►
Max Xw	°C	0.0	50.0	50.0	Maximum control deviation, that if exceeded, an alarm will be set.	Configuration ► HS ► HSx ► Screed Drying ►
Duration Xw	h	0	5	5	Delay of the Max Xw alarm.	Configuration ► HS ► HSx ► Screed Drying ►
Reset	-	1	1	0	Restarts the function.	Configuration ► HS ► HSx ► Screed Drying ►

3.2.22 Pump control

The pump can run with a constant or variable speed. The variable speed can be controlled by differential pressure or differential temperature. The setpoint of the speed, controlled by the differential pressure, is settable for comfort period and night/holiday. The setpoint of the temperature will be calculated by an outdoor compensated curve, the current value is the difference between supply and return temperature.

Parameters

Name	Unit	Min	Max	Default	Description	Menu path
Type Pump Control	-	0	2	0	0 = constant 1 = temperature 2 = pressure	Configuration ► HS ► HSx ► System ►
Outdoor Temp 1	°C	-40.0	30.0	-20.0	Only used for Type = 1	Configuration ► HS ► HSx ► Pump Control ►
Outdoor Temp 2	°C	-40.0	30.0	-15.0	Only used for Type = 1	Configuration ► HS ► HSx ► Pump Control ►
Outdoor Temp 3	°C	-40.0	30.0	-10.0	Only used for Type = 1	Configuration ► HS ► HSx ► Pump Control ►
Outdoor Temp 4	°C	-40.0	30.0	-5.0	Only used for Type = 1	Configuration ► HS ► HSx ► Pump Control ►

Name	Unit	Min	Max	Default	Description	Menu path
Outdoor Temp 5	°C	-40.0	30.0	0.0	Only used for Type = 1	Configuration ► HS ► HSx ► Pump Control ►
Outdoor Temp 6	°C	-40.0	30.0	5.0	Only used for Type = 1	Configuration ► HS ► HSx ► Pump Control ►
Outdoor Temp 7	°C	-40.0	30.0	10.0	Only used for Type = 1	Configuration ► HS ► HSx ► Pump Control ►
Outdoor Temp 8	°C	-40.0	30.0	15.0	Only used for Type = 1	Configuration ► HS ► HSx ► Pump Control ►
Difference 1	°C	0.0	50.0	10.0	Only used for Type = 1	Configuration ► HS ► HSx ► Pump Control ►
Difference 2	°C	0.0	50.0	10.0	Only used for Type = 1	Configuration ► HS ► HSx ► Pump Control ►
Difference 3	°C	0.0	50.0	10.0	Only used for Type = 1	Configuration ► HS ► HSx ► Pump Control ►
Difference 4	°C	0.0	50.0	10.0	Only used for Type = 1	Configuration ► HS ► HSx ► Pump Control ►
Difference 5	°C	0.0	50.0	10.0	Only used for Type = 1	Configuration ► HS ► HSx ► Pump Control ►
Difference 6	°C	0.0	50.0	10.0	Only used for Type = 1	Configuration ► HS ► HSx ► Pump Control ►
Difference 7	°C	0.0	50.0	10.0	Only used for Type = 1	Configuration ► HS ► HSx ► Pump Control ►
Difference 8	°C	0.0	50.0	10.0	Only used for Type = 1	Configuration ► HS ► HSx ► Pump Control ►
Differential pressure Day	kPa	0.0	100.0	20.0	Only used for Type = 2	Configuration ► HS ► HSx ► Pump Control ►
Differential pressure Night	kPa	0.0	100.0	20.0	Only used for Type = 2	Configuration ► HS ► HSx ► Pump Control ►
Pump speed Min	%	10.0	100.0	10.0	Only used for Type = 1 or 2	Configuration ► HS ► HSx ► Pump Control ►
Pump control P-band	°C / kPa	0.0	1000.0	100.0		HSx ► Temp control ►
Pump control I-time	min	0.0	1000.0	100.0		HSx ► Temp control ►

3.2.23 Actuator exercise

The *Actuator exercise* function automatically detects if the actuators (pump, valve) have moved due to having undertaken any control tasks since the last run of the function. If this is not the case, the pumps, followed by the valve, are triggered for an adjustable interval at a settable weekday and time, thereby preventing blocking in the actuator and the pump.

The sequence of exercise is the following, but depending on the type of system:

- ✓ Pump A
- ✓ Pump B (only for double pumps)
- ✓ Valve

Parameters

Name	Unit	Min	Max	Default	Description	Menu path
Mode	-	1	1	0	Turns the <i>Actuator exercise</i> function on or off. 0 = Off 1 = On	Configuration ► HS ► HSx ► Actuator Exercise ►
Day	-	0	7	0	0 = Daily 1 = Monday ... 7 = Sunday	Configuration ► HS ► HSx ► Actuator Exercise ►
Time	hh:mm	00:00	23:59	02:00	Time for actuator exercise.	Configuration ► HS ► HSx ► Actuator Exercise ►
Duration	s	0	600	120	Duration of the actuator exercise.	Configuration ► HS ► HSx ► Actuator Exercise ►

3.2.24 Status

Each circuit has the following sub statuses. For more information about the different main statuses, see *chapter 2 Information for the end user*.

Name	Description
Main Status	0 = Not active 1 = Frost 2 = Switch Off 3 = Support operation 4 = Normal operation 5 = Holiday 6 = Screed drying
Sub Status Frost Outdoor	0 = Off 1 = On
Sub Status Optimizer	0 = Off 1 = On
Sub Status Extended Run	0 = Off 1 = On
Sub Status Flash Adaption	0 = Off 1 = On
Sub Status Support Op.	0 = Off 1 = On
Sub Status Room Comp.	0 = Off 1 = On
Sub Status Boost	0 = Off 1 = On
Sub Status Wind	0 = Off 1 = On
Sub Status Delta-T	0 = Off 1 = On
Sub Status Universal Lim	0 = Off 1 = On
Sub Status Power Lim	0 = Off 1 = On
Sub Status Limitation	0 = Off 1 = On
Sub Status Dewpoint Lim	0 = Off 1 = On

Name	Description
Sub Status Delay Pump	0 = Off 1 = On
Sub Status Exercise	0 = Off 1 = On
Screed Drying Status	1 = Hold Init Temp 2 = Hold Max Temp 3 = Increase to Max 4 = Decrease to Init Temp 5 = Hold Init Temp 6 = Stop
Screed Drying Timer	The current duration of the actual status.
Nr Power Fail	Number of power failures.
Operating Hours Pump A	Counts the operating hours for pump A. Can be reset by the user.
Operating Hours Pump B	Counts the operating hours for pump B. Can be reset by the user.

3.2.25 Alarms

For more information about the alarms used by the heating systems, see the full alarm list in *Appendix D Alarm list*.

3.2.26 Manual mode

Setting parameters to manual mode is a very useful feature during commissioning or when troubleshooting.



Caution! Leaving any output in manual control means that the normal control will be suspended. Therefore, an alarm will be generated as soon as any output is set to any mode other than **Auto**.

The following parameters can be set to manual mode for the heating systems:

Parameters

Name	Unit	Min	Max	Default	Description	Menu path
Manual/Auto Valve	-	0	2	Auto	0 = Off 1 = Manual 2 = Auto	HSx ► Manual/Auto ►
Manual SetP	%	0	100	-	0-100%	HSx ► Manual/Auto ►
Manual/Auto Pump	-	0	3	Auto	0 = Manual Off 1 = Manual On Pump A 2 = Manual On Pump B 3 = Auto	HSx ► Manual/Auto ►
Manual/Auto PumpCont	%	0	100	Auto	0-100%	HSx ► Manual/Auto ►
Manual/Auto Dehumidification Output	-	0	2	Auto	0 = Manual Off 1 = Manual On 2 = Auto	HSx ► Manual/Auto ►
Manual/Auto Bypass Output	-	0	2	Auto	0 = Manual Off 1 = Manual On 2 = Auto	HSx ► Manual/Auto ►

Name	Unit	Min	Max	Default	Description	Menu path
Manual/Auto Heating	-	0	3	Auto	0 = Off 1 = On 2 = Auto	HSx ► Manual/Auto ►
Manual/Auto Cooling	-	0	3	Auto	0 = Off 1 = On 2 = Auto	HSx ► Manual/Auto ►

3.3 Domestic hot water (HW1, HW2)

The controller can be configured for one or two domestic hot water systems, HW1 and HW2.

There are six different types of domestic hot water systems available as shown below.

1. PI controlled valve for controlling the supply temperature (flow-through system)

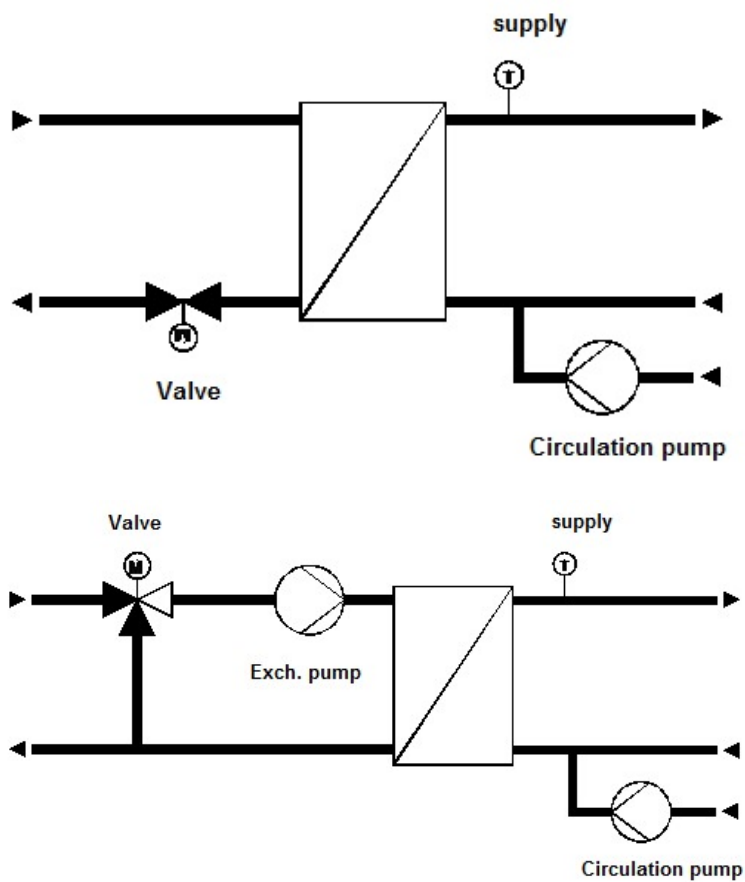

Figure 3-10 PI controlled valve for controlling the supply temperature

2. System with storage tank and tank charging pump or two-point valve

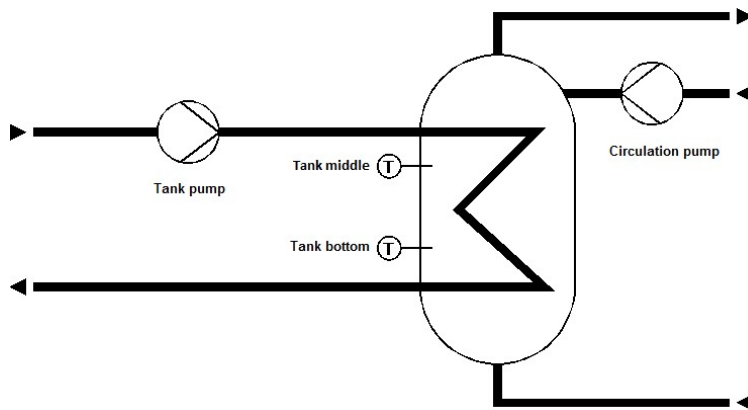

Figure 3-11 System with storage tank and tank charging pump or two-point valve

3. System with storage tank and tank charging pump plus valve

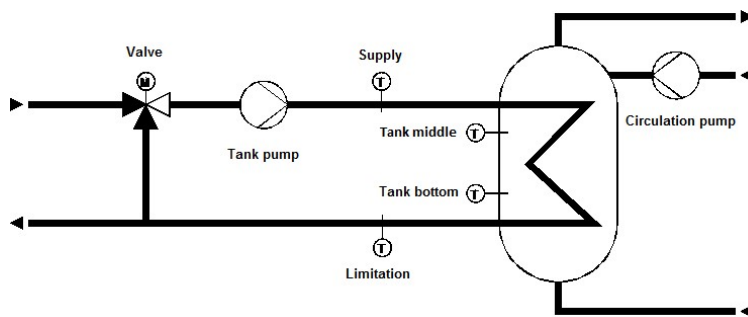

Figure 3-12 System with storage tank and tank charging pump plus valve

4. Storage tank charging systems with two point controlled tank and PI controlled load supply temperature

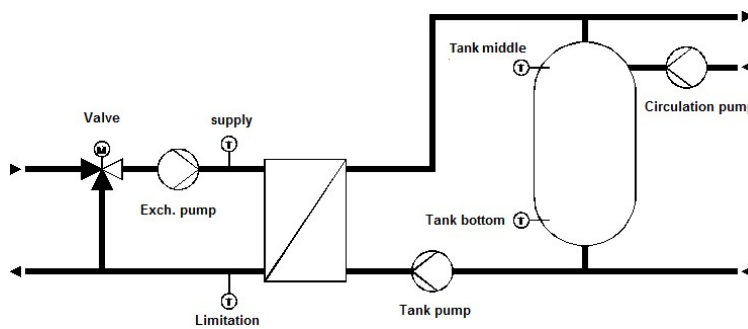

Figure 3-13 Storage tank charging systems with two point controlled tank and PI controlled load supply temperature

5. Storage tank charging systems with two-point controlled tank and PI controlled tank supply temperature

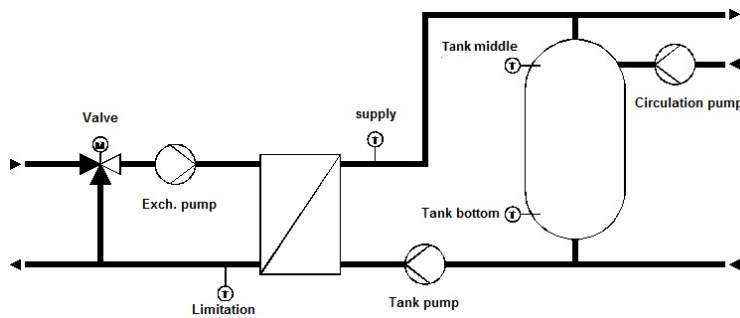

Figure 3-14 Storage tank charging systems with two-point controlled tank and PI controlled tank supply temperature

6. Storage tank charging system with two-point controlled tank and two-point controlled tank supply temperature

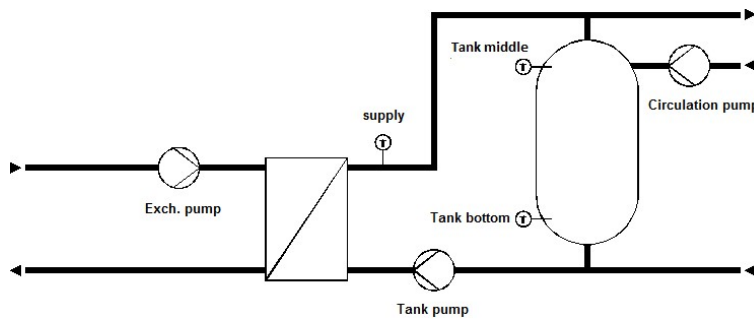

Figure 3-15 Storage tank charging system with two-point controlled tank and two-point controlled tank supply temperature

3.3.1 Inputs and outputs

The following inputs and outputs are used for domestic hot water systems.

Analogue inputs

Name	Unit	Description
Tank sensor middle	°C	Main sensor placed in the middle of the tank (system type 2-6).
Tank sensor bottom	°C	Additional sensor placed in the bottom of the tank (system type 2-6).
Supply temperature	°C	Supply temperature (system type 1) Load supply (system type 3-4) Tank supply temperature (system type 5-6)
Solar tank temperature	°C	Separate sensor for solar panel systems. If there is no solar tank sensor, the circuit will use the lowest temperature in the tank as solar tank temperature.
Circulation return temperature	°C	Used for circulation control (circulation type 3: temperature control) and in the thermal disinfection function.
Outdoor temperature	°C	Used for the frost protection function to start the circulation pump.
Limitation sensor	°C	Separate sensor for the return temperature limitation function.
External setpoint	°C	External setpoint.
Heat capacity	kW	Used for the power limitation function.

Digital inputs

Name	Unit	Description
Main switch	Off/Auto	Used to switch off the system.
Flow switch	Off/Auto	Used in system type 1 with electrical heater to shut off the output if there is no flow.
Start disinfection	-	Used to manually start thermal disinfection independently of the weekly plan. 0 = Auto 1 = Start disinfection
Feedback tank pump A	-	Feedback from tank pump A depending on the type of feedback. Motor protection: 0 = Okay 1 = Error Run indication: 0 = Off 1 = Running
Feedback tank pump B	-	Feedback from tank pump B (optional for motor protection). If there is no input configured, the function will use input for pump A for both pumps.
Feedback exchanger pump A	-	Feedback from exchanger pump A depending on the type of feedback. Motor protection: 0 = Okay 1 = Error Run indication: 0 = Off 1 = Running
Feedback exchanger pump B	-	Feedback from exchanger pump B (optional for motor protection). If there is no input configured, the function will use input for pump A for both pumps.
Feedback circulation pump A	-	Feedback from circulation pump A depending on the type of feedback. Motor protection: 0 = Okay 1 = Error Run indication: 0 = Off 1 = Running
Feedback circulation pump B	-	Feedback from circulation pump B (optional for motor protection). If there is no input configured, the function will use input for pump A for both pumps.

Analogue outputs

Name	Unit	Description
Valve continuous	%	Used to control an actuator with continuous control.

Digital outputs

Name	Unit	Description
Valve open	Off/On	Used to control an actuator with open/close control.
Valve close	Off/On	Used to control an actuator with open/close control.
Tank pump A	Off/On	Used to control a single pump or the first pump of a double pump.
Tank pump B	Off/On	Used to control the second pump of a double pump.
Exchanger pump A	Off/On	Used to control a single pump or the first pump of a double pump.
Exchanger pump B	Off/On	Used to control the second pump of a double pump.
Circulation pump A	Off/On	Used to control a single pump or the first pump of a double pump.
Circulation pump B	Off/On	Used to control the second pump of a double pump.

Name	Unit	Description
Thermal disinfection	Off/On	Used to signal that the Thermal disinfection is working.
Thermal cleaning	Off/On	Used to control the flushing of the pipes.

3.3.2 Setpoints

The following parameters are the needed and calculated setpoints for domestic hot water systems. There is one setpoint per period, and it is possible to change the setpoint for the different comfort times, the night setback and the holiday period. The boost values are used to calculate the setpoint of the control circuit depending on the tank/supply setpoint.

Parameters

Name	Unit	Min	Max	Default	Description	Menu path
Tank SetP	°C	0.0	100.0	-	Calculated tank setpoint (system type 2-6).	HWx ► Actual ►
Supply Temperature SetP	°C	0.0	100.0	-	Calculated supply setpoint (system type 1, 3-6).	HWx ► Actual ►
Hot Water Setp SP- CT1	°C	0.0	100.0	50.0	Comfort setpoint, time period 1.	HWx ► Setpoint ►
Hot Water Setp SP- CT2	°C	0.0	100.0	50.0	Comfort setpoint, time period 2.	HWx ► Setpoint ►
Hot Water Setp SP- CT3	°C	0.0	100.0	50.0	Comfort setpoint, time period 3.	HWx ► Setpoint ►
Hot Water Setp SP- CT4	°C	0.0	100.0	50.0	Comfort setpoint, time period 4.	HWx ► Setpoint ►
Hot Water Setp SP- NCT	°C	0.0	50.0	2.0	Night/Eco mode setpoint.	HWx ► Setpoint ►
Hot Water Setp SP-Hol	°C	0.0	50.0	2.0	Holiday setpoint.	HWx ► Setpoint ►
Boost Demand	°C	0.0	50.0	10.0	Boost to calculate demand (system type 3-4).	HWx ► Setpoint ►
Boost Supply	°C	0.0	50.0	5.0	Boost for tank supply (system type 5-6).	HWx ► Setpoint ►

Setpoint calculation

System type 1:

$$\text{Setpoint supply} = \text{Setpoint CTx, night or holiday}$$

System type 2–6:

$$\text{Setpoint tank} = \text{Setpoint CTx, night or holiday}$$

System type 3–4:

$$\text{Setpoint supply} = \text{Setpoint tank} + \text{Boost demand}$$

System type 5–6:

$$\text{Setpoint supply} = \text{Setpoint tank} + \text{Boost tank supply}$$

3.3.3 General settings / Configuration

To adjust the controller program to the structure of the hot water system, the type of hot water system can be configured. Depending on the type of hot water system, the valve output and the pumps can also be configured.

Parameters

Name	Unit	Min	Max	Default	Description	Menu path
Type	-	1	6	1	Type of domestic hot water system: 1 = PI controlled valve for controlling the supply temperature (flow-through system). 2 = System with storage tank and tank charging pump or two-point valve. 3 = System with storage tank and tank charging pump plus valve. 4 = Storage tank charging systems with two point controlled tank and PI controlled load supply temperature. 5 = Storage tank charging systems with two-point controlled tank and PI controlled tank supply temperature. 6 = Storage tank charging system with two-point controlled tank and two-point controlled tank supply temperature.	Configuration ► HW ► HWx ► System ►
Actuator Type Valve		1	4	1	Type of actuator: 1 = 0-10 V 2 = 2-10 V 3 = 10-2 V 4 = 10-0 V	Configuration ► HW ► HWx ► System ►
Actuator Runtime	s	0	600	120	Runtime of 3-point actuator.	Configuration ► HW ► HWx ► System ►
Tank Pump Type	-	0	1	0	Type of pump: 0 = Single 1 = Double	Configuration ► HW ► HWx ► System ►
Tank Pump Ind	-	0	1	0	Type of feedback for the pump. 0 = motor protection 1 = run indication	Configuration ► HW ► HWx ► System ►
Tank Pump Delay	s	0	200	10	Delay time of the pump indication	Configuration ► HW ► HWx ► System ►
Tank Pump Runtime	h	0	1000	100	Runtime of the pump, only used for double pumps.	Configuration ► HW ► HWx ► System ►
Exchanger Pump Type	-	0	1	0	Type of pump: 0 = Single 1 = Double	Configuration ► HW ► HWx ► System ►
Exchanger Pump Ind	-	0	1	0	Type of feedback for the pump. 0 = motor protection 1 = run indication	Configuration ► HW ► HWx ► System ►
Exchanger Pump Delay	s	0	200	10	Delay time of the pump indication.	Configuration ► HW ► HWx ► System ►
Exchanger Pump Runtime	h	0	1000	100	Runtime of the pump, only used for double pumps.	Configuration ► HW ► HWx ► System ►
Circulation Pump Type	-	0	1	0	Type of pump: 0 = Single 1 = Double	Configuration ► HW ► HWx ► System ►
Circulation Pump Ind	-	0	1	0	Type of feedback for the pump. 0 = motor protection 1 = run indication	Configuration ► HW ► HWx ► System ►
Circulation Pump Delay	s	0	200	10	Delay time of the pump indication.	Configuration ► HW ► HWx ► System ►

Name	Unit	Min	Max	Default	Description	Menu path
Circulation Pump Runtime	h	0	1000	100	Runtime of the pump, only used for double pumps.	Configuration ► HW ► HWx ► System ►
Nr Sensor NCT		0	1	0	Only used if both tank sensors are configured. 0 = Both sensors used during NCT. 1 = Only tank top sensor is used during NCT.	Configuration ► HW ► HWx ► Tank sensor ►

3.3.4 Frost protection

The *Frost protection* function is always active (unless the controller is in non-active or manual mode) in order to prevent damage (frozen pipes) to the hot water circuit. It consists of three parts:

- ✓ Frost protection tank:
Heats up the tank one time. The tank setpoint is calculated as **Frost Limit Tank** + 15°C. Hysteresis is 10 K.
- ✓ Frost protection supply:
Starts the controller for system type 1 or the loading process for system type 3-6. The supply setpoint is calculated as **Frost Limit Supply** + 15°C. Hysteresis is 1 K.
- ✓ Frost protection outdoor:
Starts the circulation pump. Hysteresis is 1 K.

Parameters

Name	Unit	Min	Max	Default	Description	Menu path
Frost Limit Tank	°C	2.0	50.0	5.0	The temperature at which the tank is heated up.	Configuration ► HW ► HWx ► Frost ►
Frost Limit Supply	°C	2.0	50.0	5.0	The temperature at which the loading system is started.	Configuration ► HW ► HWx ► Frost ►
Frost Limit Outdoor	°C	-50.0	50.0	2.0	The temperature at which the circulation pump is started.	Configuration ► HW ► HWx ► Frost ►

3.3.5 Thermal disinfection

The *Thermal disinfection* function prevents the build-up of bacteria (*Legionella*) in the water by heating up the temperature in the storage tank to at least 60°C.

If required, the storage tank setpoint, **Setpoint tank**, and the supply setpoint, **Setpoint supply**, can be adjusted in order to achieve shorter heat-up times or higher storage tank temperatures.

When activated, thermal disinfection will be performed at regular intervals, according to the configuration of the parameters **Day** (day of the week, 0 = daily) and **Time** (start time). The disinfection can also be activated by the input **Start Disinfection**.

During thermal disinfection, the switch output **Thermal Disinfection** is triggered in order to, for example, switch an additional heat source on (electric heating, magnet valve for additional volume). If the storage temperature reaches the specified setpoint, a **Hold time** can be used to hold this temperature level for a defined time. This **Hold time** is necessary if the setpoint is lower than 70°C and the bacteria are not killed directly. After the disinfection of the tank, all fittings (taps, shower heads, etc.) should be cleaned. For this purpose, the thermal disinfection triggers the switch output **Thermal Cleaning** for the running time set in the parameter **Cleaning time**. By opening a magnetic valve, automatic cleaning is possible. Alternatively, a warning device (lamp, horn, etc.) can request cleaning. During the cleaning process, the storage tank setpoint of the thermal disinfection remains effective. If required, the storage tank will be reloaded.

If the circulation pump is supposed to run during thermal disinfection, the circulation pump has to be activated (see 3.3.11 *Circulation*) with the parameter **Release TD** = 1. If there is a Circulation Return Sensor configured, the temperature at the sensor must be at least at a temperature of **SP Tank** – 10 K.

The current storage tank temperature **Last temp** and the related **Last time** and **Last date** are stored.

If the specified storage tank setpoint is not reached within the **Max time** after start of this function, an alarm is triggered with the status “thermal disinfection” and the function is interrupted.

Parameters

Name	Unit	Min	Max	Default	Description	Menu path
Mode	-	0	1	0	Activates or deactivates the <i>Thermal disinfection</i> function. 0 = Off 1 = On	Configuration ► HW ► HWx ► Disinfection ►
SP Tank	°C	60.0	100.0	70.0	Setpoint tank during thermal disinfection.	Configuration ► HW ► HWx ► Disinfection ►
SP Supply	°C	60.0	100.0	75.0	Setpoint supply during thermal disinfection.	Configuration ► HW ► HWx ► Disinfection ►
Day	-	0	7	0	Weekday for thermal disinfection. 0 = Daily 1-7 = Monday, ..., Sunday	Configuration ► HW ► HWx ► Disinfection ►
Time	-	00:00	23:59	1:00	Time for thermal disinfection.	Configuration ► HW ► HWx ► Disinfection ►
Clean Time	min	0	240	0	Running time for thermal cleaning.	Configuration ► HW ► HWx ► Disinfection ►
Hold Time	min	0	120	0		Configuration ► HW ► HWx ► Disinfection ►
Max Time	min	0	600	240	Max time for thermal disinfection.	Configuration ► HW ► HWx ► Disinfection ►
Thermal Disinfect Last Temp	°C	60.0	100.0	-	The tank temperature for the last thermal disinfection. Read only.	HWx ► Status ►
Thermal Disinfect Last Time	-	00:00	23:59	-	The time when the last thermal disinfection occurred. Read only.	HWx ► Status ►
Thermal Disinfect Last Day	-	01.01.-00	31.12.-99	-	The date when the last thermal disinfection occurred. Read only.	HWx ► Status ►
Thermal Disinfect Hold timer	min	0	120	-	Current value of the thermal disinfection hold time.	HWx ► Status ►
Thermal Disinfect Clean Timer	min	0	240	-	Current value of the thermal cleaning run time.	HWx ► Status ►
Thermal Disinfect Max Timer	min	0	600	-	Current value of the thermal disinfection max time.	HWx ► Status ►

3.3.6 Power limitation

The *Power limitation* function permits limitation of the capacity output to the domestic hot water circuit. The function will be active if a **Heat capacity** input is assigned. This function requires a heat meter to be installed and connected to provide the currently used capacity.

The limitation affects the signal to the valve of the hot water circuit by closing the valve.



Note! The function doesn't work for HW of type 2 or 6, since there is no continuous control of supply temperature for these systems.

Parameters

Name	Unit	Min	Max	Default	Description	Menu path
Limit	kW	0	10000	10000	Max limit of the consumed heat capacity.	Configuration ► HW ► HWx ► Power limitation ►
Power Limit P-Band	kW	1	1000	100	P-band.	HWx ► Temp control ►
Power Limit I-time	s	0	9999	0	I-time.	HWx ► Temp control ►
Power Limit Output	%	-	-	-	Controller output.	HWx ► Temp control ►

3.3.7 Blocking heat producer

When using a solar circuit in the DHW circuit, the criteria for activation of hot water loading can be defined with this function. The solar loading is always active. The hot water loading can be blocked, activated or reserved according to the current operating and/or non-operating time. In reserved operation, the hot water loading is not activated until the specified storage temperature difference is exceeded and the delay expired. If the hot water loading is blocked it can only be loaded via the solar system.

Parameters

Name	Unit	Min	Max	Default	Description	Menu path
Block at CT	-	0	2	1	0 = Blocked 1 = Released 2 = Reserved	Configuration ► HW ► HWx ► Block of heat prod. ►
Block at NCT	-	0	2	1	0 = Blocked 1 = Released 2 = Reserved	Configuration ► HW ► HWx ► Block of heat prod. ►
Dev load	K	0.5	50.0	10.0	Max. negative control deviation (tank sensor<setpoint) for which hot water loading in reserve operation is activated.	Configuration ► HW ► HWx ► Block of heat prod. ►
Delay load	min	1	600	300	Delay for hot water loading activation in reserve operation.	Configuration ► HW ► HWx ► Block of heat prod. ►

3.3.8 Return temperature limitation

The *Return temperature limitation* function is used to limit the temperature at the limitation sensor to a maximum value by closing the valve. The function will be active if a return temperature sensor is assigned.

If the temperature on the limitation sensor exceeds the limit, the PI-controller of this function takes over the control of the valve with a seamless transition between the PI-controllers.

The function is working as long as the output of the return limitation PI is lower than the output of the supply PI.

If the valve is completely closed by the function, it will be opened to 5% every 10 min for 15 seconds. This is needed to get enough circulation of water to be able to measure the right temperature.

Parameters

Name	Unit	Min	Max	Default	Description	Menu path
Limit	°C	2.0	160.0	100.0	Maximum temperature at the limitation sensor.	Configuration ► HW ► HWx ► Return limitation ►
Return Temp P-Band	°C	1	500.0	100.0	P-band.	HWx ► Temp control ►

Name	Unit	Min	Max	Default	Description	Menu path
Return Temp l-time	s	0	9999	100.0	l-time.	HWx ► Temp control ►
Return Temp Output	%	0	100	-	Controller output.	HWx ► Temp control ►

3.3.9 Tank control

The *Tank control* function applies to all system types in which the storage tank temperature is controlled by means of on/off control, i.e. system type 2 – 6.

Sensor 1 is placed in the middle of the tank and sensor 2 in the bottom area.

Internally, the HW is working with the lowest and highest tank temperature. If both sensors are configured, the one with the lowest temperature is used for lowest tank temperature and vice versa.

If both tank sensors are configured it is possible to determine which sensor is used depending on the non-comfort time using the **Nr Sensor NCT** parameter.

- ✓ For calculation of the current value for thermal disinfection, the function checks both sensors regardless of setting.
- ✓ For solar panel systems, the lowest of both sensors is used if there is no solar tank sensor configured.

System type 2-3 uses a positive switch difference:

- ✓ Loading is On when lowest temp and highest temp < Setpoint tank
- ✓ Loading is Off when lowest and highest temp >= Setpoint tank + Switch difference

System type 4-6 uses a negative switch difference:

- ✓ Loading is On when lowest and highest temp < Setpoint tank – Switch difference
- ✓ Loading is Off when lowest and highest temp >= Setpoint tank

Parameters

Name	Unit	Min	Max	Default	Description	Menu path
Nr Sensor NCT	-	0	1	0	Only used if both tank sensors are configured. 0 = Both sensors are used during NCT 1 = Only the middle tank sensor is used during NCT.	Configuration ► HW ► HWx ► Tank sensor ►
Tank Control Hyst Day	°C	0.1	50.0	5.0	Hysteresis used during comfort mode.	HWx ► Temp control ►
Tank Control Hyst Night	°C	0.1	50.0	5.0	Hysteresis used during eco mode.	HWx ► Temp control ►

3.3.10 Supply control

For system type 1 or systems in combination with system type 1, the supply temperature is controlled continuously by triggering a valve. The behaviour of the PI controller can be compensated by adjusting parameters of the controller.

For system type 3-4, the load supply temperature **Supply temperature** is controlled by means of **Setpoint supply** during HW tank loading. This setpoint is the sum of **Setpoint tank** and **Boost demand**.

For system type 5-6, the tank supply temperature is controlled by means of **Setpoint supply** during HW tank loading. This setpoint is the sum of **Setpoint tank** and **Boost supply**.

The temperature is PI controlled by a valve.

Hysteresis: Switch difference for exchanger load pump for system type 6.

- ✓ Exchanger pump is On when tank supply < Setpoint tank supply
- ✓ Exchanger pump is Off when tank supply \geq Setpoint tank supply + Switch difference

Parameters

Name	Unit	Min	Max	Default	Description	Menu path
Supply Control P-band+	°C	1	1000	25	P-band for opening the valve.	HWx ▶ Temp control ▶
Supply Control I-time+	s	0	9999	100	I-time for opening the valve.	HWx ▶ Temp control ▶
Supply Control D-time+	s	0	9999	0	D-time for opening the valve.	HWx ▶ Temp control ▶
Supply Control P-band-	°C	1	1000	25	P-band for closing the valve.	HWx ▶ Temp control ▶
Supply Control I-time-	s	0	9999	100	I-time for closing the valve.	HWx ▶ Temp control ▶
Supply Control D-time-	s	0	9999	0	D-time for closing the valve.	HWx ▶ Temp control ▶
Hysteresis	°C	0.0	50.0	10.0	Switch difference for the exchanger load pump (system type 6).	HWx ▶ Temp control ▶

3.3.11 Circulation

This menu permits defining at what point an installed circulation pump should run.

- ✓ If the **Main status** of the circuit is **Not active** or **Switch Off**, the pump is stopped.
- ✓ If the **Main status** is **Frost**, the pump runs all the time.

Different types of circulation control can be used for the pump:

0: Off

1: Permanently On

2: Pulsed mode

- ✓ Pump is running for **On-time**, and then it stops for **Off-time**.

3: Temperature control (this option needs an installed circulation return sensor).

- ✓ Pump is on until the **Circulation return temperature** is higher than the highest value of both tank sensors minus **Return-Temp Control Temp-Diff**.
- ✓ Then the pump stops for **Off-time**.
- ✓ After **Off-time**, the pump starts for 10 seconds to measure the right temperature.

Parameters

Name	Unit	Min	Max	Default	Description	Menu path
Rel CTx	-	0	3	1	Control mode for the circulation pump during CTx. 0 = Off 1 = On 2 = Pulsed mode 3 = Temperature control mode	Configuration ▶ HW ▶ HWx ▶ Circulation ▶
Rel NCT	-	0	3	1	Control mode for the circulation pump during NO. 0 = Off 1 = On 2 = Pulsed mode 3 = Temperature control mode	Configuration ▶ HW ▶ HWx ▶ Circulation ▶

Name	Unit	Min	Max	Default	Description	Menu path
Rel Load	-	0	1	1	Release of circulation pump during tank load. 0 = Off 1 = On	Configuration ► HW ► HWx ► Circulation ►
Rel TD	-	0	1	1	Control mode for the circulation pump during thermal disinfection. 0 = Off 1 = On 2 = Pulsed mode 3 = Temperature control mode	Configuration ► HW ► HWx ► Circulation ►
Time Control On-time	min	0	60	2	Pump on time when in <i>Pulsed</i> mode.	Configuration ► HW ► HWx ► Circulation ►
Time Control Off-time	min	0	60	30	Pump off time when in <i>Pulsed</i> mode or <i>Temperature control</i> mode.	Configuration ► HW ► HWx ► Circulation ►
Return-Temp Control Temp-Diff	°C	0.0	50.0	10.0	Temperature difference to stop the circulation in <i>Temperature control</i> mode.	Configuration ► HW ► HWx ► Circulation ►

3.3.12 Switch off delay

The *Switch off delay* function permits delaying storage tank loading switch-off or delaying deactivation of the heat exchanger. The function is divided into two parts, delay of load and delay of heat exchanger. Both parts work in sequence, delay of heat exchanger starts after delay of load.

- ✓ Delay of load is used to cool down the heat producer if the HW sent the highest demand. It works for all types of HW systems if the circuit stops loading the tank or stops the production of tap water for system type 1. While the function runs, the tank pump and the valve are still working.
- ✓ Delay of heat exchanger is used to remove the remaining energy from the heat exchanger for system type 4–6. For system type 4 and 5 the valve is closed, and tank pump and exchanger pump runs.

Parameters

Name	Unit	Min	Max	Default	Description	Menu path
Delay Load	min	0.0	60.0	3.0	Switch off delay for storage tank loading.	Configuration ► HW ► HWx ► Switch off delay ►
Delay Exch	s	0	600	120	Switch off delay for heat exchanger.	Configuration ► HW ► HWx ► Switch off delay ►

3.3.13 Actuator exercise

The *Actuator exercise* function automatically detects if the actuators (pump, valve) have moved due to having undertaken any control tasks since the last run of the function. If this is not the case, the pumps, followed by the valve, are triggered for an adjustable interval at a settable weekday and time, thereby preventing blocking in the actuator and the pumps.

The sequence of exercise is the following:

1. Pump A
2. Pump B (only for double pumps)
3. Valve

Parameters

Name	Unit	Min	Max	Default	Description	Menu path
Mode	-	0	1	0	Activates or deactivates the <i>Actuator exercise</i> function. 0 = Off 1 = On	Configuration ► HW ► HWx ► Actuator exercise ►
Day	-	0	7	0	Weekday for actuator exercise. 0 = Daily 1-7 = Monday, ..., Sunday	Configuration ► HW ► HWx ► Actuator exercise ►
Time	hh:mm	00:00	23:59	02:00	Time for actuator exercise.	Configuration ► HW ► HWx ► Actuator exercise ►
Duration	s	0	600	120	Duration of the actuator exercise.	Configuration ► HW ► HWx ► Actuator exercise ►

3.3.14 Status

Each circuit has the following sub statuses. For more information about the different main statuses, see *chapter 2 Information for the end user*.

Name	Description
Main Status	0 = Not active 1 = Frost 2 = Switch off 3 = Support operation 4 = Normal operation 5 = Holiday
Sub Status Load	0 = Off 1 = Load 2 = Hold 3 = Cooling
Sub Status 2PntOff	0 = Off 1 = On
Sub Status Switch Off	0 = Off 1 = SwitchOffLoad 2 = SwitchOffExchanger
Sub Status Return Lim	0 = Off 1 = On
Sub Status Circulation	0 = Off 1 = On 2 = Timer controlled 3 = Temperature controlled
Sub Status Frost Outd	0 = Off 1 = On
Sub Status Power Lim	0 = Off 1 = On
Sub Status Exercise	0 = Off 1 = On
Sub Status Block heat producer	0 = Off 1 = On
Operating Hours Tank Pump A	Operating hours for Storage tank load pump A.
Operating Hours Tank Pump B	Operating hours for Storage tank load pump B.
Operating Hours Exchanger Pump A	Operating hours for Exchanger pump A.
Operating Hours Exchanger Pump B	Operating hours for Exchanger pump B.

Name	Description
Operating Hours Circulation Pump A	Operating hours for Circulation pump A.
Operating Hours Circulation Pump B	Operating hours for Circulation pump B.

3.3.15 Alarms

For more information about the alarms used by the domestic hot water systems, see the full alarm list in *Appendix D Alarm list*.

3.3.16 Manual mode

Setting parameters to manual mode is a very useful feature during commissioning or when troubleshooting.



Caution! Leaving any output in manual control means that the normal control will be suspended. Therefore, an alarm will be generated as soon as any output is set to any mode other than **Auto**.

The following parameters can be set to manual mode for the domestic hot water systems:

Parameters

Name	Unit	Min	Max	Default	Description	Menu path
Manual/Auto Valve	-	0	2	Auto	0 = Off 1 = Manual 2 = Auto	HWx ► Manual/Auto ►
Manual Set	%	0	100	-	0-100%	HWx ► Manual/Auto ►
Manual/Auto Tank-Pump	-	0	3	Auto	0 = Off 1 = Pump A On 2 = Pump B On 3 = Auto	HWx ► Manual/Auto ►
Manual/Auto Exchanger-Pump	-	0	3	Auto	0 = Off 1 = Pump A On 2 = Pump B On 3 = Auto	HWx ► Manual/Auto ►
Manual/Auto Circulation-Pump	-	0	3	Auto	0 = Off 1 = Pump A On 2 = Pump B On 3 = Auto	HWx ► Manual/Auto ►
Manual/Auto Thermal disinfect. Manual	-	0	2	Auto	0 = Off 1 = On 2 = Auto	HWx ► Manual/Auto ►
Manual/Auto Thermal disinfect. Clean	-	0	3	Auto	0 = Off 1 = On 2 = Auto	HWx ► Manual/Auto ►

3.4 Buffer tank (HPI)

A buffer tank has many positive effects on a system, including reducing starts and stops from a boiler or heat pump and generating cheaper heat production when available (solar, pellet, etc.). The temperature in the buffer tank is controlled according to the demands of the internal heat circuits and domestic hot water circuits, as well as demand via 0...10 V. The controller makes use of all available heat producers using the following priority:

1. Solar panel
2. Internal heat producer

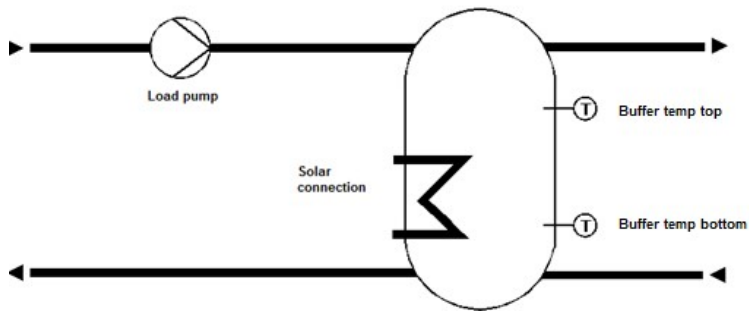

Figure 3-16 Buffer tank

3.4.1 Inputs and outputs

The following inputs and outputs are used for the buffer tank.

Analogue inputs

Name	Unit	Description
Buffer temp top	°C	Buffer temperature top, main sensor.
Buffer temp bottom	°C	Buffer temperature bottom, additional sensor.
Additional heat source	°C	Temperature additional heat source, additional sensor.
Demand heating extern	°C	Demand for an external heat consumer.

Digital inputs

Name	Unit	Description
Main switch	Off/Auto	Used to switch off the system.
Feedback load pump A	-	Feedback from pump A depending on the type of feedback. Motor protection: 0 = Okay 1 = Error Run indication: 0 = Off 1 = Running
Feedback load pump B	-	Feedback from pump B depending on the type of feedback. Motor protection: 0 = Okay 1 = Error Run indication: 0 = Off 1 = Running

Name	Unit	Description
Feedback additional heat source pump A	-	Feedback from pump A depending on the type of feedback. Motor protection: 0 = Okay 1 = Error Run indication: 0 = Off 1 = Running
Feedback additional heat source pump B	-	Feedback from pump B depending on the type of feedback. Motor protection: 0 = Okay 1 = Error Run indication: 0 = Off 1 = Running

Analogue outputs

Name	Unit	Description
Demand	°C	Internal connection to the heat producer to send the heating/cooling demand.

Digital outputs

Name	Unit	Description
Load pump A	Off/On	Used to control a single pump or the first pump of a double pump.
Load pump B	Off/On	Used to control the second pump of a double pump.
Additional heat source pump A	Off/On	Used to control a single pump or the first pump of a double pump.
Additional heat source pump B	Off/On	Used to control the second pump of a double pump.

3.4.2 Setpoints

The program can control normal buffer tanks with one zone. The Setpoint menu displays the currently calculated buffer temperature setpoint **Setpoint Act** based on the demand from the internal heating circuits, the domestic hot water circuits and external heat consumers or on the **Constant Setpoint** depending on the settings. A **Hysteresis** can also be set in order to overheat the buffer tank for switching off the heat producers.

Parameters

Name	Unit	Min	Max	Default	Description	Menu path
Setpoint Act	°C	2.0	160.0	-	Calculated setpoint, only used if the parameter Temperature SP Type is 1.	Buffer ► Setpoint ►
Hysteresis	°C	1.0	25.0	5.0	Hysteresis to overheat the buffer.	Buffer ► Setpoint ►
Constant Setpoint	°C	0.0	90.0	50.0	Constant setpoint, only used if the parameter Temperature SP Type is 0.	Buffer ► Setpoint ►

3.4.3 Buffer tank configuration

Name	Unit	Min	Max	Default	Description	Menu path
Temperature SP Type	-	0	1	1	Type of setpoint. 0 = constant setpoint 1 = calculated setpoint depending on demand	Configuration ► Buffer ► System ►
Max Temp	°C	20.0	90.0	70.0	Maximum buffer tank temperature.	Configuration ► Buffer ► System ►
Pump Type	-	0	1	0	Type of load pump. 0 = single pump 1 = twin pump	Configuration ► Buffer ► System ►
Pump Ind	-	0	1	0	Type of feedback for the load pump. 0 = motor protection 1 = run indication	Configuration ► Buffer ► System ►
Pump Delay	s	0	200	10	Delay time of the pump indication.	Configuration ► Buffer ► System ►
Pump Runtime	h	1	100	100	Runtime of the load pump.	Configuration ► Buffer ► System ►

3.4.4 Boost

The *Boost* function can be used to set a boost for each demand (HS, HW, ...). The boost can be used to compensate for loss of energy in long pipes or to disconnect an energy consumer (HS, HW).

The internal demand of the circuit is calculated as:

$$\text{internal demand} = \text{demand} * (1 + \text{Boost}/100)$$

A boost of -100% disconnects the circuit from the setpoint calculation.

Parameters

Name	Unit	Min	Max	Default	Description	Menu path
Boost HS1	%	-100	100	0	Boost for the demand of heating system 1 (only if Type of setpoint = 1).	Configuration ► Buffer ► Boost ►
Boost HS2	%	-100	100	0	Boost for the demand of heating system 2 (only if Type of setpoint = 1).	Configuration ► Buffer ► Boost ►
Boost HS3	%	-100	100	0	Boost for the demand of heating system 3 (only if Type of setpoint = 1).	Configuration ► Buffer ► Boost ►
Boost HS4	%	-100	100	0	Boost for the demand of heating system 4 (only if Type of setpoint = 1).	Configuration ► Buffer ► Boost ►
Boost HW1	%	-100	100	0	Boost for the demand of domestic hot water system 1 (only if Type of setpoint = 1).	Configuration ► Buffer ► Boost ►
Boost HW2	%	-100	100	0	Boost for the demand of domestic hot water system 2 (only if Type of setpoint = 1).	Configuration ► Buffer ► Boost ►
Boost EXT	%	-100	100	0	Boost for external demand (only if Type of setpoint = 1).	Configuration ► Buffer ► Boost ►

3.4.5 Additional heat source

The *Additional heat source* function permits activating and configuring control of an additional heat source, which can be used to load the buffer tank with additional heat, if available. A maximum temperature and frost limit can also be defined.

Parameters

Name	Unit	Min	Max	Default	Description	Menu path
TempDiffOn	K	0.0	30.0	8.0	The temperature difference between the additional heat source temperature and the buffer temperature at which the pump is switched on.	Configuration ► Buffer ► Add. Heat Source ►
TempDiffOff	K	0.0	20.0	2.0	The temperature difference between the additional heat source temperature and the buffer temperature at which the pump is switched off.	Configuration ► Buffer ► Add. Heat Source ►
Max Temp	°C	50.0	160.0	90.0	The temperature at which the additional heat source pump is always switched on.	Configuration ► Buffer ► Add. Heat Source ►
Frost Limit	°C	-60.0	10.0	-10.0	The temperature at which the additional heat source pump is always switched on.	Configuration ► Buffer ► Add. Heat Source ►
Add HeatS Pump Runtime	h	0	999	100	Runtime of the additional heat source pump.	Configuration ► Buffer ► System ►

3.4.6 Block heat producer

When using a solar circuit or additional heat source in the buffer, the criteria for activation of buffer loading can be defined with this function. The solar loading and additional heat source is always active. The buffer loading can be activated or reserved. In reserved operation, the buffer loading is not activated until the specified storage temperature difference is exceeded and the delay expired. If the buffer loading is blocked, the buffer can only be loaded via the solar circuit or additional heat source.

Parameters

Name	Unit	Min	Max	Default	Description	Menu path
Block at Load	-	1	2	1	1 = Released 2 = Reserved	Configuration ► Buffer ► Block of heat prod. ►
Dev Release Load	K	0.5	50.0	10.0	Max. negative control deviation (actual<-setpoint) for which buffer loading in reserve operation is activated if exceeded at tank sensor.	Configuration ► Buffer ► Block of heat prod. ►
Delay Release Load	min	1	600	10	Delay for buffer loading activation in reserve operation.	Configuration ► Buffer ► Block of heat prod. ►

3.4.7 Actuator exercise

The *Actuator exercise* function automatically detects if the actuators (pump, valve) have moved due to having undertaken any control tasks since the last run of the function. If this is not the case, the pumps, followed by the valve, is triggered for an adjustable interval at a settable weekday and time, thereby preventing blocking in the actuator and the pump. The sequence of exercise is the following, but depending on the type of system:

1. Pump A

2. Pump B (only for double pumps)

3. Valve

Parameters

Name	Unit	Min	Max	Default	Description	Menu path
Mode	-	1	1	0	Turns the <i>Actuator exercise</i> function on or off. 0 = Off 1 = On	Configuration ► Buffer ► Actuator exercise ►
Day		0	7	0	0 = Daily 1 = Monday...7 = Sunday	Configuration ► Buffer ► Actuator exercise ►
Time	hh:mm	00:00	23:59	02:00	Time for actuator exercise.	Configuration ► Buffer ► Actuator exercise ►
Duration	s	0	600	120	Duration of the actuator exercise.	Configuration ► Buffer ► Actuator exercise ►

3.4.8 Status

The buffer tank has the following sub statuses. For more information about the different main statuses, see *chapter 2 Information for the end user*.

Name	Description
Main Status	0 = Not active 2 = Switch off 4 = Normal operation
Sub Status Load	0 = Off 1 = Load 2 = Hold
Sub Status Exercise	0 = Off 1 = On
Sub status Block heat producer	0 = Off 1 = On
Operating Hours Pump A	Operating hours for load pump A.
Operating Hours Pump B	Operating hours for load pump B.
Add Heat source Pump A	Operating hours for additional heat source pump A.
Add Heat source Pump B	Operating hours for additional heat source pump B.

3.4.9 Alarms

For more information about the alarms used by the buffer tank, see the full alarm list in *Appendix D Alarm list*.

3.4.10 Manual mode

Setting parameters to manual mode is a very useful feature during commissioning or when troubleshooting.



Caution! Leaving any output in manual control means that the normal control will be suspended. Therefore, an alarm will be generated as soon as any output is set to any mode other than **Auto**.

The following parameters can be set to manual mode for the buffer tank:

Parameters

Name	Unit	Min	Max	Default	Description	Menu path
Manual/Auto Pump	-	0	3	Auto	0 = Off 1 = Pump A On 2 = Pump B On 3= Auto	Buffer ► Manual/ Auto ►
Add Heat source Pump	-	0	2	Auto	0 = Off 1 = Pump A On 2 = Pump B On 3 = Auto	Buffer ► Manual/ Auto ►

3.5 District heating system (DHSI)

A district heating circuit is a demand based system. It's controlling the secondary temperature with an actuator, using continuous or 3-point control signal. The system collects the demand from the internal and/or external heat consumer.

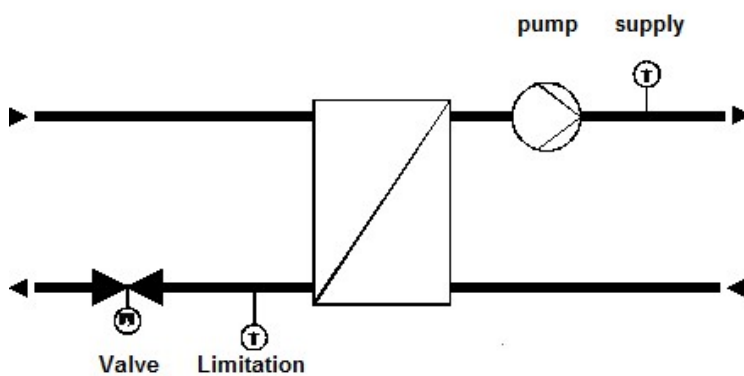

Figure 3-17 District heating system

3.5.1 Inputs and outputs

The following inputs and outputs are used for district heating systems.

Analogue inputs

Name	Unit	Description
Secondary supply temperature	°C	Main sensor.
Primary return temperature	°C	Sensor for return limitation.
Outdoor temperature	°C	Used for frost protection to start the pump.
Heat capacity	kW	Used for primary limitation of heating capacity.
Demand heating extern	°C	Demand for an external heat consumer 0-10 V input.

Digital inputs

Name	Unit	Description
Main switch	Off/Auto	Used to switch off the system.
Feedback pump A	-	Feedback from pump A depending on the type of feedback. Motor protection: 0 = Okay 1 = Error Run indication: 0 = Off 1 = Running
Feedback pump B	-	Feedback from pump B depending on the type of feedback. Motor protection: 0 = Okay 1 = Error Run indication: 0 = Off 1 = Running

Analogue outputs

Name	Unit	Description
Valve continuous	%	Used to control an actuator with continuous control.

Digital outputs

Name	Unit	Description
Valve open	Off/On	Used to control an actuator with open/close control.
Valve close	Off/On	Used to control an actuator with open/close control.
Pump A	Off/On	Used to control a single pump or the first pump of a double pump.
Pump B	Off/On	Used to control the second pump of a double pump.

3.5.2 Setpoints

The **Actual** menu displays the calculated setpoint **Supply Temperature SetP**.

Parameters

Name	Unit	Min	Max	Default	Description	Menu path
Supply Temperature SetP	°C	2.0	160.0	-	Calculated setpoint.	DHS1 ► Actual ►

3.5.3 General settings / Configuration

To adjust the controller program to the structure of the district heating circuit, the type of the valve output can be configured and a pump can be configured.

Parameters

Name	Unit	Min	Max	Default	Description	Menu path
Actuator Type Valve	-	1	4	1	Type of actuator: 1 = 0-10 V 2 = 2-10 V 3 = 10-2 V 4 = 10-0 V	Configuration ► DHS1 ► System ►
Actuator Runtime	s	10	600	120	Runtime of 3-point actuator.	Configuration ► DHS1 ► System ►
Pump Type	-	0	1	0	Type of pump: 0 = Single 1 = Double	Configuration ► DHS1 ► System ►
Pump Ind	-	0	1	0	Type of feedback for the pump. 0 = motor protection 1 = run indication	Configuration ► DHS1 ► System ►
Pump Delay	s	0	200	10	Delay time of the pump indication.	Configuration ► DHS1 ► System ►
Pump Runtime	h	1	1000	100	Runtime of the pump, only used for double pumps.	Configuration ► DHS1 ► System ►

3.5.4 Boost

The *Boost* function can be used to set a boost for each demand (HS, HW, etc.). The boost can be used to compensate for loss of energy in long pipes or to disconnect an energy consumer (HS, HW).

The internal demand of the circuit is calculated as:

$$\text{internal demand} = \text{demand} * (1 + \text{Boost}/100)$$

A boost of -100% disconnects the circuit from the setpoint calculation.

Parameters

Name	Unit	Min	Max	Default	Description	Menu path
Boost HS1	%	-100	100	0	Boost of demand for heating system 1.	Configuration ► DHS1 ► Boost ►
Boost HS2	%	-100	100	0	Boost of demand for heating system 2.	Configuration ► DHS1 ► Boost ►
Boost HS3	%	-100	100	0	Boost of demand for heating system 3.	Configuration ► DHS1 ► Boost ►
Boost HS4	%	-100	100	0	Boost of demand for heating system 4.	Configuration ► DHS1 ► Boost ►
Boost HW1	%	-100	100	0	Boost of demand for domestic hot water system 1.	Configuration ► DHS1 ► Boost ►
Boost HW2	%	-100	100	0	Boost of demand for domestic hot water system 2.	Configuration ► DHS1 ► Boost ►
Boost EXT	%	-100	100	0	Boost for external demand.	Configuration ► DHS1 ► Boost ►

3.5.5 Setpoint limitation

The *Setpoint limitation* function consists of three different sub-functions.

The functions are only active if the circuit is in normal operation (Main status = 4).

Static limitation:

- ✓ Limitation of the setpoint using the parameters **Min SP** and **Max SP**.
- ✓ Limitation of setpoint adjustment speed: Limitation of the setpoint adjustment speed using the **Ramp-** (negative deviation) and **Ramp+** (positive deviation) parameters. A ramp of 1400 means that the function is disabled. When the function is activated it starts at the current supply temperature.
- ✓ Limitation of deviation: Limitation of the deviation of the setpoint compared to the supply temperature. The setpoint can't be higher than the supply temperature + **Max Dev**. This limitation is mainly used when you have steam as a heat source to avoid steam explosions that could occur if the temperature difference between the steam and the water is too big.

Parameters

Name	Unit	Min	Max	Default	Description	Menu path
Setpoint Limitation Min SP	°C	2.0	90.0	2.0	Minimum setpoint temperature.	Configuration ► DHS1 ► Setpoint limitation ►
Setpoint Limitation Max SP	°C	2.0	160.0	85.0	Maximum setpoint temperature.	Configuration ► DHS1 ► Setpoint limitation ►
Setpoint Limitation Ramp +	°C/h	0.1	1400.0	1400.0	Maximum setpoint adjustment speed when increasing the setpoint.	Configuration ► DHS1 ► Setpoint limitation ►
Setpoint Limitation Ramp-	°C/h	0.1	1400.0	1400.0	Maximum setpoint adjustment speed when decreasing the setpoint.	Configuration ► DHS1 ► Setpoint limitation ►
Setpoint Limitation Max Dev	°C	1.0	100.0	100.0	Maximum difference between the setpoint and the current supply temperature.	Configuration ► DHS1 ► Setpoint limitation ►

3.5.6 Supply control

The *Temp control* menu contains the settings of the PI-supply controller.

Parameters

Name	Unit	Min	Max	Default	Description	Menu path
Supply Control P-Band+	°C	1	1000	25	P-band for opening the valve.	DHS1 ► Temp control ►
Supply Control I-Time+	s	0	9999	100	I-time for opening the valve.	DHS1 ► Temp control ►
Supply Control P-Band-	°C	1	1000	25	P-band for closing the valve.	DHS1 ► Temp control ►
Supply Control I-Time-	s	0	9999	100	I-time for closing the valve.	DHS1 ► Temp control ►
Supply Control Ouput	%	0	100	-	Controller output.	DHS1 ► Temp control ►

3.5.7 Supply limitation

The *Supply limitation* function ensures that the supply temperature will not rise above a given value. This function closes the valve.

Parameters

Name	Unit	Min	Max	Default	Description	Menu path
Supply Limitation Mode	-	0	1	0	Turns the <i>Supply limitation</i> function on or off. 0 = Off 1 = On	Configuration ► DHS1 ► Supply limitation ►
Max-Supply	°C	2.0	90.0	90.0	Maximum supply temperature.	Configuration ► DHS1 ► Supply limitation ►

3.5.8 Power limitation

The *Power limitation* function permits limitation of the capacity output to the district heating circuit. The function will be active if a **Heat capacity** input is assigned. This function requires a heat meter to be installed and connected to provide the currently used capacity. The limitation affects the signal to the valve of the district heating system by closing the valve.

Parameters

Name	Unit	Min	Max	Default	Description	Menu path
Limit	kW	0	10000	10000	Max limit of the consumed heat capacity.	Configuration ► DHS1 ► Power limitation ►
P-Band	kW	1	1000	100	P-band.	DHS1 ► Temp control ►
I-time	s	0	9999	0	I-time.	DHS1 ► Temp control ►
Output	%	0	100	-	Controller output.	DHS1 ► Temp control ►

3.5.9 Frost limitation

The *Frost limitation* function is used to keep the water in the pipes in motion to prevent freezing. It is only available if a pump is installed. If the outdoor temperature falls below **Frost Limit Outdoor** the pump is always on.

Parameters

Name	Unit	Min	Max	Default	Description	Menu path
Frost Limit Outdoor	°C	-40.0	50.0	2.0	The temperature at which the pump is always on.	Configuration ► DHS1 ► Frost ►

3.5.10 Return temperature limitation

The *Return temperature limitation* function is used to limit the temperature at the primary return sensor to a maximum value by closing the valve. The function is active if a return temperature sensor is assigned.

It is possible to define different limits for HS and HW. The current limit can be calculated depending on the outdoor temperature.

If the temperature on the limitation sensor exceeds the limit, the PI-controller of this function takes over the control of the valve with a seamless transition between the PI-controllers.

The function is working as long as the output of the return limitation PI is lower than the output of the supply PI.

If the valve is completely closed by the function, it will be opened to 5% every 10 min for 15 seconds. This is needed to get a circulation of water to measure the right temperature.

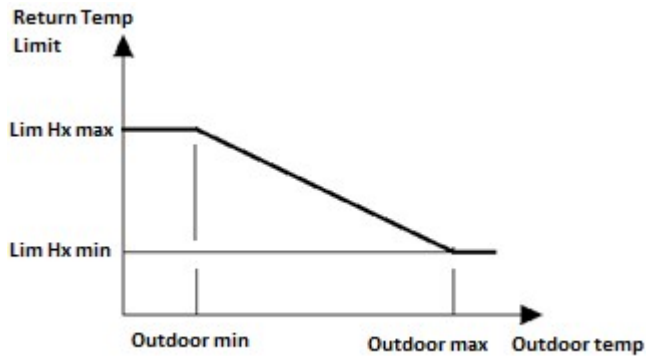

Figure 3-18 Return temperature limitation

Parameters

Name	Unit	Min	Max	Default	Description	Menu path
Return Limitation LimHS min	°C	2.0	160.0	60.0	Limit at Entry-Point Outdoor Max , "Outdoor max" in the picture above. Used if the demand is from HS.	Configuration ► DHS1 ► Return limitation ►
Return Limitation LimHS max	°C	2.0	160.0	60.0	Limit at Entry-Point Outdoor Min , "Outdoor min" in the picture above. Used if the demand is from HS.	Configuration ► DHS1 ► Return limitation ►
Return Limitation LimHW min	°C	2.0	160.0	80.0	Limit at Entry-Point Outdoor Max , "Outdoor max" in the picture above. Used if the demand is from HW.	Configuration ► DHS1 ► Return limitation ►
Return Limitation LimHW max	°C	2.0	160.0	80.0	Limit at Entry-Point Outdoor Min , "Outdoor min" in the picture above. Used if the demand is from HW.	Configuration ► DHS1 ► Return limitation ►
Return Limitation Entry-Point 1 Outdoor Min	°C	-20.0	20.0	0.0	"Outdoor min" in the picture above.	Configuration ► DHS1 ► Return limitation ►
Return Limitation Entry-Point 2 Outdoor Max	°C	-20.0	20.0	0.0	"Outdoor max" in the picture above.	Configuration ► DHS1 ► Return limitation ►
Return Limitation P-Band	°C	1	1000	25	P-band	DHS1 ► Temp control ►
Return Limitation I-Time	s	0	9999	100	I-time	DHS1 ► Temp control ►
Return Temperature Setp	°C	2.0	160.0	-	The current calculated limit.	DHS1 ► Actual ►
Return Temperature Act	%	0	100.0	-	The current correction signal of the PI controller.	DHS1 ► Actual ►

3.5.11 Pump

It is possible to activate a switch off delay of the pump used after the district heating circuit changed its state to shutoff.

Parameters

Name	Unit	Min	Max	Default	Description	Menu path
Switch-Off Delay	s	0	600	120	Switch off delay of the pump.	Configuration ► DHS1 ► Pump ►

3.5.12 Actuator exercise

The *Actuator exercise* function automatically detects if the actuators (pump, valve) have moved due to having undertaken any control tasks since the last run of the function. If this is not the case, the pumps, followed by the valve, are triggered for an adjustable interval at a settable weekday and time, thereby preventing blocking in the actuator and the pump.

The sequence of exercise is the following:

1. Pump A
2. Pump B (only for double pumps)
3. Valve

Parameters

Name	Unit	Min	Max	Default	Description	Menu path
Mode	-	0	1	0	Activates or deactivates the <i>Actuator exercise</i> function. 0 = Off 1 = On	Configuration ► DHS1 ► Actuator exercise ►
Day	-	0	7	0	Weekday for actuator exercise. 0 = Daily 1-7 = Monday, ..., Sunday	Configuration ► DHS1 ► Actuator exercise ►
Time	hh:mm	00:00	23:59	02:00	Time for actuator exercise.	Configuration ► DHS1 ► Actuator exercise ►
Duration	s	0	600	120	Duration of the actuator exercise.	Configuration ► DHS1 ► Actuator exercise ►

3.5.13 Status

The district heating system has the following sub statuses. For more information about the different main statuses, see *chapter 2 Information for the end user*.

Name	Description
Main Status	0 = Not active 1 = Frost 2 = Switch off 4 = Normal operation
Sub Status Frost Out	0 = Off 1 = On
Sub Status Supply Lim	0 = Off 1 = On
Sub Status Switch Off Del	0 = Off 1 = On
Sub Status Power Lim	0 = Off 1 = On
Sub Status Exercise	0 = Off 1 = On
Sub Status Setpoint Lim	0 = Off 1 = On
Operating Hours Pump A	Operating hours for pump A.
Operating Hours Pump B	Operating hours for pump B.

3.5.14 Alarms

For more information about the alarms used by the district heating system, see the full alarm list in *Appendix D Alarm list*.

3.5.15 Manual mode

Setting parameters to manual mode is a very useful feature during commissioning or when troubleshooting.



Caution! Leaving any output in manual control means that the normal control will be suspended. Therefore, an alarm will be generated as soon as any output is set to any mode other than **Auto**.

The following parameters can be set to manual mode for the district heating system:

Parameters

Name	Unit	Min	Max	Default	Description	Menu path
Manual/Auto Valve	-	0	2	Auto	0 = Off 1 = Manual 2 = Auto	DHS1 ► Manual/Auto ►
Manual Set	%	0	100	-	0-100%	DHS1 ► Manual/Auto ►
Manual/Auto Pump	-	0	3	Auto	0 = Off 1 = Pump A On 2 = Pump B On 3 = Auto	DHS1 ► Manual/Auto ►

3.6 Solar

The solar circuit can be used either for heating the domestic hot water storage tank or in order to heat up the buffer tank. The basic function of the solar circuit is to control the temperature difference between the collector sensor and the storage sensor.

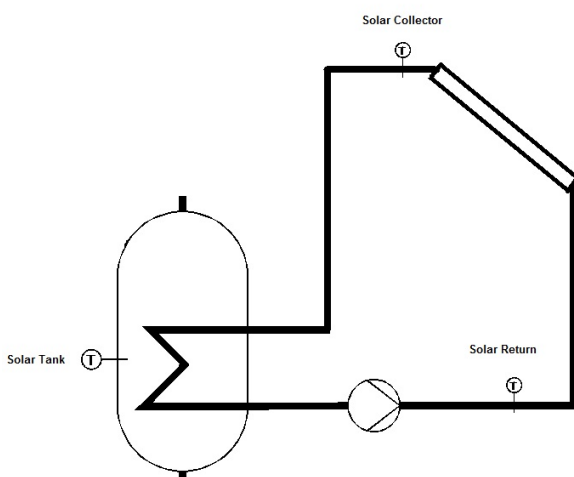

Figure 3-19 Solar circuit

3.6.1 Inputs and outputs

The following inputs and outputs are used for solar panel systems:

Analogue inputs

Name	Unit	Description
Solar HW1	°C	Solar sensor in Domestic hot water 1.
Solar HW2	°C	Solar sensor in Domestic hot water 2.
Solar buffer	°C	Solar sensor in the buffer tank.
Solar collector temperature	°C	Solar collector sensor.
Solar return temperature	°C	Solar collector return sensor.

Digital inputs

Name	Unit	Description
Main switch	Off/Auto	Used to switch off the system.
Feedback pump A	-	Feedback from pump A depending on the type of feedback. Motor protection: 0 = Okay 1 = Error Run indication: 0 = Off 1 = Running
Feedback pump B	-	Feedback from pump B depending on the type of feedback. Motor protection: 0 = Okay 1 = Error Run indication: 0 = Off 1 = Running

Analogue outputs

Name	Unit	Description
Continuous pump	%	Output to control the speed of a pump.

Digital outputs

Name	Unit	Description
Solar pump A	Off/On	Used to control a single pump or the first pump of a double pump.
Solar pump B	Off/On	Used to control the second pump of a double pump.
Switch HW-buffer	Off/On	0 = Load HW tank 1 = Load buffer tank
Cool down	Off/On	Cool down the solar collector.

3.6.2 General settings / Configuration

The *Solar* function permits activating and configuring control of an integrated solar thermal collector, which can be used to load the buffer tank or a hot water tank with additional heat, if available. A maximum temperature and frost limit can also be defined.

The basic function of the solar circuit is to control the temperature difference between the collector sensor and the storage tank sensor. If the temperature difference rises above **T-Diff On**, the solar pump is switched on.

A P-controller controls the difference between the tank temperature and the collector temperature by reducing the pump speed.

This pump is switched off when the temperature difference decreases below **T-Diff Off**.

Parameters

Name	Unit	Min	Max	Default	Description	Menu path
Pump Type	-	0	1	0	Type of pump used. 0 = single pump 1 = twin pump	Configuration ► Solar ► System ►
Pump Ind	-	0	1	0	Type of feedback for the load pump. 0 = motor protection 1 = run indication	Configuration ► Solar ► System ►
Pump Delay	s	0	200	10	Delay time of the pump indication.	Configuration ► Solar ► System ►
Pump Runtime	h	1	1000	100	Runtime of the load pump.	Configuration ► Solar ► System ►
Priority Buffer/HW	-	0	2	0	Priority of Buffer and HW. 0 = Auto 1 = only HW 2 = only Buffer	Configuration ► Solar ► System ►
Priority HW1/HW2	-	0	1	0	0 = Use HW1 (default) 1 = Use HW2	Configuration ► Solar ► System ►
Solar 2 Point Control T-Diff On	°C	0.0	30.0	8.0	The temperature difference between the collector sensor and storage tank sensor at which the solar pump is switched on.	Configuration ► Solar ► System ►
Solar 2 Point Control T-Diff Off	°C	0.0	20.0	2.0	The temperature difference between the collector sensor and storage tank sensor at which the solar pump is switched off.	Configuration ► Solar ► System ►
P-Band	°C	1	100	8	P-band	Solar ► Temp control ►
Temperature Limits Max-T Coll	°C	70.0	160.0	110.0	Temperature at which the solar pump is always switched on.	Configuration ► Solar ► System ►
Temperature Limits Frost Coll	°C	-50.0	10.0	-10.0	Temperature at which the solar pump is always switched on.	Configuration ► Solar ► System ►

3.6.3 Actuator exercise

The *Actuator exercise* function automatically detects if the actuators (pump, valve) have moved due to having undertaken any control tasks since the last run of the function. If this is not the case, the pumps, followed by the valve, are triggered for an adjustable interval at a settable weekday and time, thereby preventing blocking in the actuator and the pump.

The sequence of exercise is the following:

1. Pump A
2. Pump B (only for double pumps)

3. Valve

Parameters

Name	Unit	Min	Max	Default	Description	Menu path
Mode	-	0	1	0	Activates or deactivates the <i>Actuator exercise</i> function. 0 = Off 1 = On	Configuration ► Solar ► Actuator exercise ►
Day	-	0	7	0	Weekday for actuator exercise. 0 = Daily 1-7 = Monday, ..., Sunday	Configuration ► Solar ► Actuator exercise ►
Time	hh:mm	00:00	23:59	02:00	Time for actuator exercise.	Configuration ► Solar ► Actuator exercise ►
Duration	s	0	600	120	Duration of the actuator exercise.	Configuration ► Solar ► Actuator exercise ►

3.6.4 Status

The solar circuit has the following sub statuses. For more information about the different main statuses, see *chapter 2 Information for the end user*.

Name	Description
Main status	0 = Not active 2 = Switch off 4 = Normal operation
Sub status Solar	0 = Off 1 = Load 2 = Hold 3 = Cooling 4 = Frost
Sub Status Exercise	0 = Off 1 = On
Operating Hours Pump Cont	Operating hours for the continuous pump
Operating Hours Pump-A	Operating hours for pump A.
Operating Hours Pump-B	Operating hours for pump B.

3.6.5 Alarms

For more information about the alarms used by the solar circuit, see the full alarm list in *Appendix D Alarm list*.

3.6.6 Manual mode

Setting parameters to manual mode is a very useful feature during commissioning or when troubleshooting.



Caution! Leaving any output in manual control means that the normal control will be suspended. Therefore, an alarm will be generated as soon as any output is set to any mode other than **Auto**.

The following parameters can be set to manual mode for the solar circuit:

Parameters

Name	Unit	Min	Max	Default	Description	Menu path
Manual/Auto P-Cont	-	0	2	Auto	0 = Off 1 = Manual 2 = Auto	Solar ► Manual/Auto ►
Manual Set	%	0	100	-	0-100%	Solar ► Manual/Auto ►
Manual/Auto Pump	-	0	3	Auto	0 = Off 1 = Pump A On 2 = Pump B On 3 = Auto	Solar ► Manual/Auto ►
Manual/Auto Load Buffer Output	-	0	2	Auto	0 = Off 1 = On 2 = Auto	Solar ► Manual/Auto ►
Cool down	-	0	1	Auto	0 = Off 1 = On 2 = Auto	

3.7 Boiler control (HB1–HB4)

The controller can be configured for boiler control with 1-4 boilers. Depending on the type of boiler control, the burners of each boiler can be configured as 1-step, 2-step and modulating. The burners are controlled either by a PI-controller with settable P-band and I-time or by using a thermostat function.

3.7.1 Inputs and outputs

The following inputs and outputs are used for boiler control systems.

Analogue inputs

Name	Unit	Description
Supply temperature	°C	
Return temperature	°C	
Boiler 1 supply temperature	°C	
Boiler 1 return temperature	°C	
Boiler 2 supply temperature	°C	
Boiler 2 return temperature	°C	
Boiler 3 supply temperature	°C	
Boiler 3 return temperature	°C	
Boiler 4 supply temperature	°C	
Boiler 4 return temperature	°C	

Digital inputs

Name	Unit	Description
Run indication Boiler 1	Off/On	
Run indication / alarm Boiler 1 Pump A	Off/On	
Run indication / alarm Boiler 1 Pump B	Off/On	

Name	Unit	Description
Run indication / alarm Boiler 1 Return Pump	Off/On	
Run indication Boiler 2	Off/On	
Run indication / alarm Boiler 2 Pump A	Off/On	
Run indication / alarm Boiler 2 Pump B	Off/On	
Run indication / alarm Boiler 2 Return Pump	Off/On	
Run indication Boiler 3	Off/On	
Run indication / alarm Boiler 3 Pump A	Off/On	
Run indication / alarm Boiler 3 Pump B	Off/On	
Run indication / alarm Boiler 3 Return Pump	Off/On	
Run indication Boiler 4	Off/On	
Run indication / alarm Boiler 4 Pump A	Off/On	
Run indication / alarm Boiler 4 Pump B	Off/On	
Run indication / alarm Boiler 4 Return Pump	Off/On	
Run indication / alarm Transport Pump A	Off/On	
Run indication / alarm Transport Pump B	Off/On	
Boiler Alarm	Off/On	
Expansion Vessel	Off/On	
External stop Boiler 1–4	Off/On	
Pressure / Flow switch	Off/On	

Analogue outputs

Name	Unit	Description
Boiler 1 Modulating	%	
Boiler 1 Return Valve	%	
Boiler 2 Modulating	%	
Boiler 2 Return Valve	%	
Boiler 3 Modulating	%	
Boiler 3 Return Valve	%	
Boiler 4 Modulating	%	
Boiler 4 Return Valve	%	

Digital outputs

Name	Unit	Description
Boiler 1 Burner	Off/On	
Boiler 1 Burner (high effect)	Off/On	
Boiler 1 Return Pump	Off/On	
Boiler 1 Pump A	Off/On	
Boiler 1 Pump B	Off/On	
Boiler 2 Burner	Off/On	
Boiler 2 Burner (high effect)	Off/On	

Name	Unit	Description
Boiler 2 Return Pump	Off/On	
Boiler 2 Pump A	Off/On	
Boiler 2 Pump B	Off/On	
Boiler 3 Burner	Off/On	
Boiler 3 Burner (high effect)	Off/On	
Boiler 3 Return Pump	Off/On	
Boiler 3 Pump A	Off/On	
Boiler 3 Pump B	Off/On	
Boiler 4 Burner	Off/On	
Boiler 4 Burner (high effect)	Off/On	
Boiler 4 Return Pump	Off/On	
Boiler 4 Pump A	Off/On	
Boiler 4 Pump B	Off/On	

3.7.2 Setpoint

The boiler control setpoint can be configured to one of the following alternatives:

- ✓ Constant setpoint: A fixed settable value.
- ✓ Circuit-dependent setpoint: Can be set to any of the following options:
 1. HS-dependent
 2. HW-dependent
 3. HP1-dependent
 4. HS- and HW-dependent
 5. HS- and HP1-dependent
 6. HW- and HP1-dependent
 7. HS-, HW- and HP1-dependent

When a circuit-dependent setpoint has been configured, the boiler control setpoint is dependent on the setpoints of other circuits. The circuit whose setpoint is currently the highest will, together with an added offset (pre-set to 5 degrees), constitute the boiler control setpoint.

- ✓ Outdoor compensated setpoint = the setpoint varies with the outdoor temperature.

Heat demand

In addition to the internal setpoint, an analogue input may also be configured to receive a setpoint from another controller. The highest setpoint (internal or external) will be used as the relevant setpoint for the boiler.

Parameters

Name	Unit	Min	Max	Default	Description	Menu path
HB Setpoint	°C	2.0	160.0	-	The current setpoint.	HB ► Actual/ Setpoint ►
Offset HS Setpoint	°C	0.0	20.0	5.0	Offset of circuit dependent setpoint.	HB ► Actual/ Setpoint ►

Name	Unit	Min	Max	Default	Description	Menu path
Type of Setpoint	-	0	5	0	0 = Constant 1 = HS 2 = HS, HW 3 = HS, HP 4 = HS, HW, HP 5 = Curve	Configuration ► HB ► General ►
Constant Setpoint	°C	2.0	100.0	36.0	Constant setpoint.	HB ► Actual/ Setpoint ► Outd temp setP ►
Outdoor Temp 1	°C	-40.0	30.0	-20.0		HB ► Actual/ Setpoint ► Outd temp setP ►
Outdoor Temp 2	°C	-40.0	30.0	-15.0		HB ► Actual/ Setpoint ► Outd temp setP ►
Outdoor Temp 3	°C	-40.0	30.0	-10.0		HB ► Actual/ Setpoint ► Outd temp setP ►
Outdoor Temp 4	°C	-40.0	30.0	-5.0		HB ► Actual/ Setpoint ► Outd temp setP ►
Outdoor Temp 5	°C	-40.0	30.0	0.0		HB ► Actual/ Setpoint ► Outd temp setP ►
Outdoor Temp 6	°C	-40.0	30.0	5.0		HB ► Actual/ Setpoint ► Outd temp setP ►
Outdoor Temp 7	°C	-40.0	30.0	10.0		HB ► Actual/ Setpoint ► Outd temp setP ►
Outdoor Temp 8	°C	-40.0	30.0	15.0		HB ► Actual/ Setpoint ► Outd temp setP ►
Curve Output 1	°C	2.0	100.0	67.0		HB ► Actual/ Setpoint ► Outd temp setP ►
Curve Output 2	°C	2.0	100.0	63.0		HB ► Actual/ Setpoint ► Outd temp setP ►
Curve Output 3	°C	2.0	100.0	59.0		HB ► Actual/ Setpoint ► Outd temp setP ►
Curve Output 4	°C	2.0	100.0	55.0		HB ► Actual/ Setpoint ► Outd temp setP ►
Curve Output 5	°C	2.0	100.0	53.0		HB ► Actual/ Setpoint ► Outd temp setP ►
Curve Output 6	°C	2.0	100.0	43.0		HB ► Actual/ Setpoint ► Outd temp setP ►
Curve Output 7	°C	2.0	100.0	35.0		HB ► Actual/ Setpoint ► Outd temp setP ►
Curve Output 8	°C	2.0	100.0	25.0		HB ► Actual/ Setpoint ► Outd temp setP ►
Man Paral Dis	°C	-10.0	10.0	5.0	Offset of the curve setpoint.	HB ► Actual/ Setpoint ► Outd temp setP ►

3.7.3 Type of boiler control

The boiler can be set as off/on control, control using off/on/modulating or as control using modulating (parameter **Type of Boiler Ctrl**).

Off/on control

In this control mode, the burners are controlled using a thermostat function. The burners for each boiler can be configured as 1- or 2-step burners with settable hysteresis, Switch difference 1 (SD1) and Switch difference 2 (SD2) respectively, and an offset for step 2 (high output).

Starting and stopping takes place according to the formulas below, see *Figure 3-20 Off/on control* for an example:

```

Start low output = SP - SD1
Start high output = SP - SD2 - offset
Stop low output = SP
Stop high output = SP - offset

```

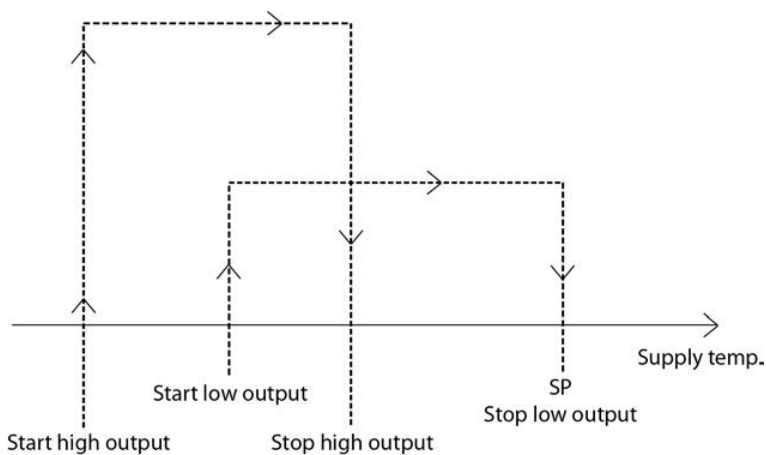

Figure 3-20 Off/on control

Control using off/on modulating

In this control mode, the boilers are controlled by a PI-controller with settable P-band and I-time. The initial boiler can either be set to modulating (0...10 V), off/on (1-step) or off/on/high (2-step). Boiler 2-4 can be either 1-step or 2-step.

When boiler 1 is configured as modulating:

Upon a heating requirement increase the analogue output is first controlled 0...10 V. If the heating requirement becomes so great that the first burner is inadequate, the first digital output will be added. The analogue output is kept to 0 V for a settable time period and the controller is blocked. Thereafter, the analogue output will once more be controlled 0...10 V, depending on the heating requirement. A decrease in heating requirement will result in the opposite function (see *Figure 3-21 Control using off/on modulating, analogue*). The controller will increase/decrease by one step at a time, and each time a digital output is switched on or off, the controller will be blocked for the set time period.

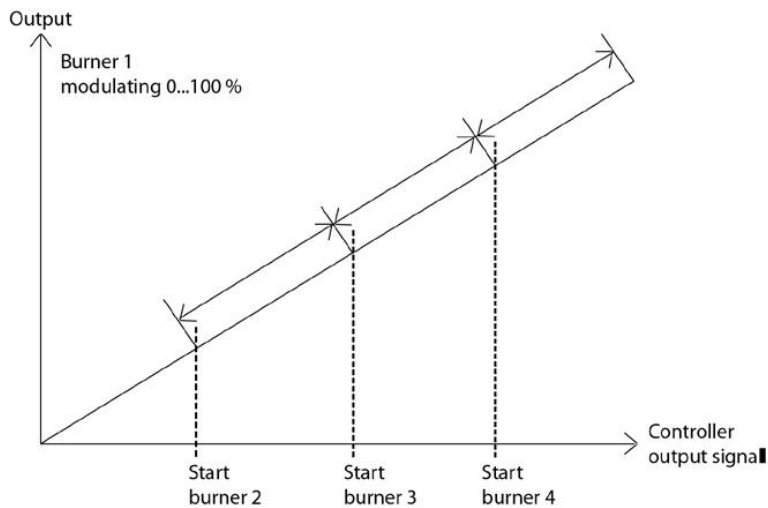

Figure 3-21 Control using off/on modulating, analogue

When boiler 1 is configured to a digital function (1-step or 2-step) the digital outputs will step into sequence by one step at a time, and each time a digital output is switched on or off the controller will be blocked for the set time period (see Figure 3-22 Control using off/on modulating, digital).

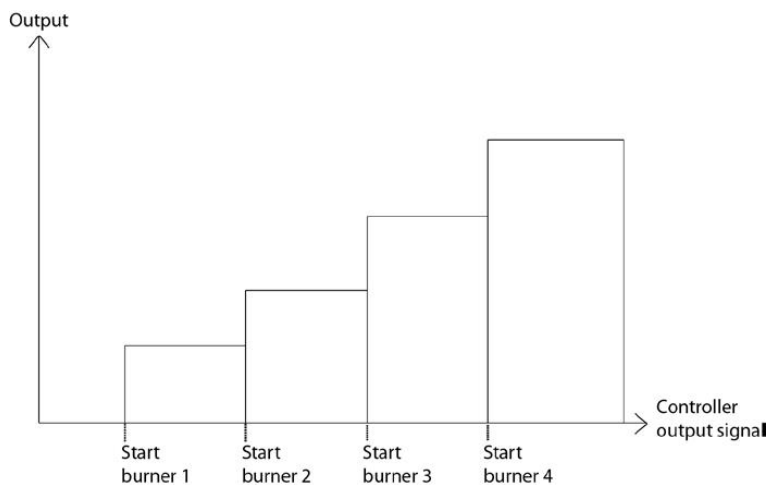

Figure 3-22 Control using off/on modulating, digital

Control using modulating

In this control mode, the burners can only be set as modulating burners (0...10 V). The burners are controlled by a PI-controller with settable P-band and I-time. When there is a heating requirement, the burners are controlled 0...10 V in sequence, and each time a digital output is switched on or off the controller will be blocked for the set time period (see Figure 3-23 Control using modulating).

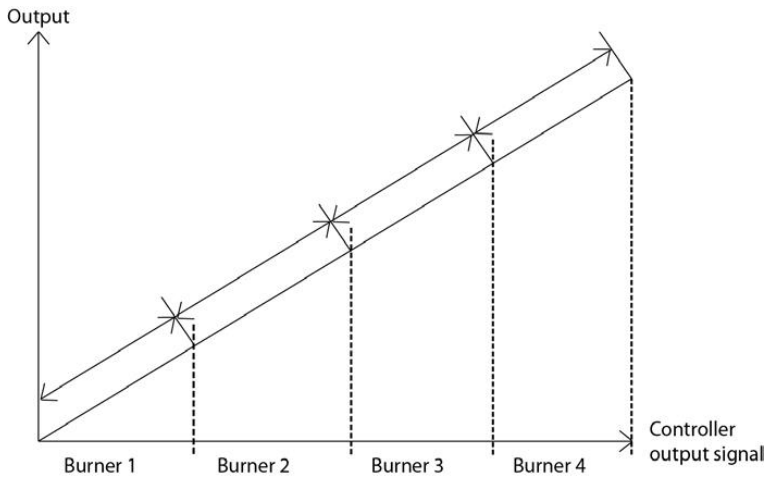

Figure 3-23 Control using modulating

Parameters

Name	Unit	Min	Max	Default	Description	Menu path
Type of Boiler Ctrl	-	0	2	0	Type of boiler: 0 = Off/on control 1 = Control using off/on/modulating 2 = Control using modulating	Configuration ► HB ► General ►
Number of Boilers	-	0	4	0		Configuration ► HB ► General ►
P-band	°C	1	1000	30		HB ► Temp control ►
I-time	s	0	9999	15		HB ► Temp control ►
Time That The Ctrl is Blocked at Start/Stop	s	0	600	180	Time that the controller is blocked at start / stop of boiler.	HB ► Temp control ►
Hysteresis	%	0	100	0.5	Hysteresis for start / stop boiler.	HB ► Temp control ►

3.7.4 Boiler settings

The type of burner and the type of modulation can be set separately for each boiler.

A minimum run and stop time for each boiler are individually settable. When the heating requirement increases, the next boiler can start only after the previous boiler has completed its minimum runtime, and when the heating requirement decreases the boiler will not switch off until after its minimum runtime has been completed. A stopped boiler can start again only after it has been switched off for a minimum duration of the set stop time.

These variables are both set to 180 seconds for all boilers.

Parameters

Name	Unit	Min	Max	Default	Description	Menu path
Type of Burner Boiler 1	-	0	3	0	Type of Burner, Boiler 1 0 = 1-step 1 = 2-step 3 = Modulating	Configuration ► HB ► HB1 ►
Burner1 Control Signal	-	1	4	1	Actuator Type, Boiler 1 1 = 0-10 V 2 = 2-10 V 3 = 10-2 V 4 = 10-0 V	Configuration ► HB ► HB1 ►
Min run time Boiler 1	s	0	3600	180		Configuration ► HB ► HB1 ►
Min stop time Boiler 1	s	0	3600	180		Configuration ► HB ► HB1 ►
Switch Diff1 (Boiler 1)	°C	0	100	5	Switch difference 1, see section <i>Off/on control</i> .	HB ► Actual/Setpoint ► HB1 ►
Switch Diff2 (Boiler 1)	°C	0	100	5	Switch difference 2, see section <i>Off/on control</i> .	HB ► Actual/Setpoint ► HB1 ►
Off Sw Diff2 (Boiler 1)	°C	0	100	3	Offset switch difference 2, see section <i>Off/on control</i> .	HB ► Actual/Setpoint ► HB1 ►
Type of Burner Boiler 2	-	0	3	0	0 = 1-step 1 = 2-step 3 = Modulating	Configuration ► HB ► HB2 ►
Burner2 Control Signal	-	1	4	1	Actuator Type, Boiler 2 1 = 0-10 V 2 = 2-10 V 3 = 10-2 V 4 = 10-0 V	Configuration ► HB ► HB2 ►
Min run time Boiler 2	s	0	3600	180		Configuration ► HB ► HB2 ►
Min stop time Boiler 2	s	0	3600	180		Configuration ► HB ► HB2 ►
Switch Diff1 (Boiler 2)	°C	0	100	5	Switch difference 1, see section <i>Off/on control</i> .	HB ► Actual/Setpoint ► HB2 ►
Switch Diff2 (Boiler 2)	°C	0	100	5	Switch difference 2, see section <i>Off/on control</i> .	HB ► Actual/Setpoint ► HB2 ►
Off Sw Diff2 (Boiler 2)	°C	0	100	3	Offset switch difference 2, see section <i>Off/on control</i> .	HB ► Actual/Setpoint ► HB2 ►
Type of Burner Boiler 3	-	0	3	0	0 = 1-step 1 = 2-step 3 = Modulating	Configuration ► HB ► HB3 ►
Burner3 Control Signal	-	1	4	1	Actuator Type, Boiler 3 1 = 0-10 V 2 = 2-10 V 3 = 10-2 V 4 = 10-0 V	Configuration ► HB ► HB3 ►
Min run time Boiler 3	s	0	3600	180		Configuration ► HB ► HB3 ►
Min stop time Boiler 3	s	0	3600	180		Configuration ► HB ► HB3 ►
Switch Diff1 (Boiler 3)	°C	0	100	5	Switch difference 1, see section <i>Off/on control</i> .	HB ► Actual/Setpoint ► HB3 ►
Switch Diff2 (Boiler 3)	°C	0	100	5	Switch difference 2, see section <i>Off/on control</i> .	HB ► Actual/Setpoint ► HB3 ►
Off Sw Diff2 (Boiler 3)	°C	0	100	3	Offset switch difference 2, see section <i>Off/on control</i> .	HB ► Actual/Setpoint ► HB3 ►

Name	Unit	Min	Max	Default	Description	Menu path
Type of Burner Boiler 4	-	0	3	0	0 = 1-step 1 = 2-step 3 = Modulating	Configuration ► HB ► HB4 ►
4 Control Signal	-	1	4	1	Actuator Type, Boiler 4 1 = 0-10 V 2 = 2-10 V 3 = 10-2 V 4 = 10-0 V	Configuration ► HB ► HB4 ►
Min run time Boiler 4	s	0	3600	180		Configuration ► HB ► HB4 ►
Min stop time Boiler 4	s	0	3600	180		Configuration ► HB ► HB4 ►
Switch Diff1 (Boiler 4)	°C	0	100	5	Switch difference 1, see section <i>Off/on control</i> .	HB ► Actual/Setpoint ► HB4 ►
Switch Diff2 (Boiler 4)	°C	0	100	5	Switch difference 2, see section <i>Off/on control</i> .	HB ► Actual/Setpoint ► HB4 ►
Off Sw Diff2 (Boiler 4)	°C	0	100	3	Offset switch difference 2, see section <i>Off/on control</i> .	HB ► Actual/Setpoint ► HB4 ►

3.7.5 Starting order

Boiler starting order can be set individually:

- ✓ Fixed starting order. The boilers will always start in the same order: Fixed Boiler 1, Fixed Boiler 2, Fixed Boiler 3 and Fixed Boiler 4.
- ✓ Runtime-controlled: The boilers will start in order based on shortest runtime.
- ✓ Alternating: The start order of the boilers will be changed once per week, alternatively once per day, at a settable time. When changing, the start order will be displaced by one step. I.e.: The boiler which before changing started first will, after changing, start the next boiler, and so on. When the start order is changed, all boilers will shut down and start again if a heating requirement exists.

Parameters

Name	Unit	Min	Max	Default	Description	Menu path
Boiler 1 Start Mode	-	0	5	0	0 = Alternating 1 = Boiler 1 is always first in the starting order 2 = Boiler 1 is always second in the starting order 3 = Boiler 1 is always third in the starting order 4 = Boiler 1 is always last in the starting order 5 = Run time controlled	Configuration ► HB ► HB1 ►
Boiler 2 Start Mode	-	0	5	0	0 = Alternating 1 = Boiler 2 is always first in the starting order 2 = Boiler 2 is always second in the starting order 3 = Boiler 2 is always third in the starting order 4 = Boiler 2 is always last in the starting order 5 = Run time controlled	Configuration ► HB ► HB2 ►

Name	Unit	Min	Max	Default	Description	Menu path
Boiler 3 Start Mode	-	0	5	0	0 = Alternating 1 = Boiler 3 is always first in the starting order 2 = Boiler 3 is always second in the starting order 3 = Boiler 3 is always third in the starting order 4 = Boiler 3 is always last in the starting order 5 = Run time controlled	Configuration ► HB ► HB3 ►
Boiler 4 Start Mode	-	0	5	0	0 = Alternating 1 = Boiler 4 is always first in the starting order 2 = Boiler 4 is always second in the starting order 3 = Boiler 4 is always third in the starting order 4 = Boiler 4 is always last in the starting order 5 = Run time controlled	Configuration ► HB ► HB4 ►
Boiler Exchange Weekday	-	0	7	0	0 = Never 1 = Monday...7 = Sunday	Configuration ► HB ► General ► Type of Boiler ctrl ►
Boiler Exchange Hour	-	0	23	10		Configuration ► HB ► General ► Type of Boiler ctrl ►

3.7.6 Boiler exercise

The boilers can be exercised for a settable duration on a settable time and weekday. It is also possible to set the number of weeks between each exercise.

Parameters

Name	Unit	Min	Max	Default	Description	Menu path
Boiler 1 Exercise	-	0	1	0	0 = Off 1 = On	Configuration ► HB ► HB1 ►
Boiler 1 Exercise No of Weeks	-	0	52	4	Number of weeks between exercises.	Configuration ► HB ► HB1 ►
Boiler 1 Exercise Day	-	1	7	7	Weekday for exercise. 1 = Monday...7 = Sunday	Configuration ► HB ► HB1 ►
Boiler 1 Exercise Hour	-	0	23	15	Hour for exercise.	Configuration ► HB ► HB1 ►
Exercise time Boiler 1	min	0	120	5	Duration for exercise.	Configuration ► HB ► HB1 ►
Boiler 2 Exercise	-	0	1	0	0 = Off 1 = On	Configuration ► HB ► HB2 ►
Boiler 2 Exercise No of Weeks	-	0	52	4	Number of weeks between exercises.	Configuration ► HB ► HB2 ►
Boiler 2 Exercise Day	-	1	7	7	Weekday for exercise. 1 = Monday...7 = Sunday	Configuration ► HB ► HB2 ►
Boiler 2 Exercise Hour	-	0	23	15	Hour for exercise.	Configuration ► HB ► HB2 ►
Exercise time Boiler 2	min	0	120	5	Duration for exercise.	Configuration ► HB ► HB2 ►
Boiler 3 Exercise	-	0	1	0	0 = Off 1 = On	Configuration ► HB ► HB3 ►

Name	Unit	Min	Max	Default	Description	Menu path
Boiler 3 Exercise No of Weeks	-	0	52	4	Number of weeks between exercises.	Configuration ► HB ► HB3 ►
Boiler 3 Exercise Day	-	1	7	7	Weekday for exercise. 1 = Monday...7 = Sunday	Configuration ► HB ► HB3 ►
Boiler 3 Exercise Hour	-	0	23	15	Hour for exercise.	Configuration ► HB ► HB3 ►
Exercise time Boiler 3	min	0	120	5	Duration for exercise.	Configuration ► HB ► HB3 ►
Boiler 4 Exercise	-	0	1	0	0 = Off 1 = On	Configuration ► HB ► HB4 ►
Boiler 4 Exercise No of Weeks	-	0	52	4	Number of weeks between exercises.	Configuration ► HB ► HB4 ►
Boiler 4 Exercise Day	-	1	7	7	Weekday for exercise. 1 = Monday...7 = Sunday	Configuration ► HB ► HB4 ►
Boiler 4 Exercise Hour	-	0	23	15	Hour for exercise.	Configuration ► HB ► HB4 ►
Exercise time Boiler 4	min	0	120	5	Duration for exercise.	Configuration ► HB ► HB4 ►

3.7.7 Boiler return temperature

To minimize the risk of condensation accumulating in the boiler, it is important that the temperature is higher than the condensation temperature. This can be solved in two ways:

✓ Common return temperature

Setting a common return temperature sensor can reduce the risk of condensation. If the temperature at the sensor falls below a settable value (**Block Valves at Low Boiler Return Temp**, default 40°C), the valves of all HS circuits will be forced to close. The valves will remain closed for as long as the boiler return temperature is lower than the settable value + hysteresis (settable parameter **Block Valves at Low Boiler Return Hyst**, default 10°C).

✓ Individual return temperatures

Each boiler has a return temperature sensor that controls a mixing valve or a pump. If the return temperature falls below a settable temperature (**Return Temp SetP**, default 40°C):

- ✓ The mixing valve will be controlled for increased recirculation by a P-controller with settable P-band (**HBx Return Temp P-Band/Hyst**, default 10°C)

or

- ✓ The pump will be switched on with a settable hysteresis (**HBx Return Temp P-Band/Hyst**, default 10°C).

Parameters

Name	Unit	Min	Max	Default	Description	Menu path
Block valves at low boiler return temp	°C	0	100	40		Configuration ► HB ► General ►
Block valves at low boiler return Hyst	°C	1	50	10		Configuration ► HB ► General ►
HB1 Return Limitation Type	-	0	1	0	Type of return limitation Boiler 1. 0 = Valve 1 = Pump	Configuration ► HB ► HB1 ►
Return-Pump Ind (Boiler 1)	-	0	1	0	Type of run indication 0 = Motor protection 1 = Run indication Only visible if HB1 Return Limitation Type = 1	Configuration ► HB ► Boiler pumps ► HB1 ►

Name	Unit	Min	Max	Default	Description	Menu path
Return-Pump Delay (Boiler 1)	s	0	200	10	Delay time of the pump indication.	Configuration ► HB ► Boiler pumps ► HB1 ►
Return Temp SetP (Boiler 1)	°C	0	100	40		HB ► Actual/ Setpoint ► HB1 ►
HB1 Return Temp P-Band/Hyst	°C	0	50	10		HB ► Temp control ►
Boiler 2 Return Limitation Type	-	0	1	0	Type of return limitation Boiler 2. 0 = Valve 1 = Pump	Configuration ► HB ► HB2 ►
Return-Pump Ind (Boiler 2)	-	0	1	0	Type of run indication 0 = Motor protection 1 = Run indication Only visible if HB2 Return Limitation Type = 1	Configuration ► HB ► Boiler pumps ► HB2 ►
Return-Pump Delay (Boiler 2)	s	0	200	10	Delay time of the pump indication	Configuration ► HB ► Boiler pumps ► HB2 ►
Return Temp SetP (Boiler 2)	°C	0	100	40		HB ► Actual/ Setpoint ► HB2 ►
Boiler 2 Return Temp P-Band/Hyst	°C	0	50	10		HB ► Temp control ►
Boiler 3 Return Limitation Type	-	0	1	0	Type of return limitation Boiler 3. 0 = Valve 1 = Pump	Configuration ► HB ► HB3 ►
Return-Pump Ind (Boiler 3)	-	0	1	0	Type of run indication 0 = Motor protection 1 = Run indication Only visible if HB3 Return Limitation Type = 1	Configuration ► HB ► Boiler pumps ► HB3 ►
Return-Pump Delay (Boiler 3)	s	0	200	10	Delay time of the pump indication.	Configuration ► HB ► Boiler pumps ► HB3 ►
Return Temp SetP (Boiler 3)	°C	0	100	40		HB ► Actual/ Setpoint ► HB3 ►
Boiler 3 Return Temp P-Band/Hyst	°C	0	50	10		HB ► Temp control ►
Boiler 4 Return Limitation Type	-	0	1	0	Type of return limitation Boiler 4. 0 = Valve 1 = Pump	Configuration ► HB ► HB4 ►
Return-Pump Ind (Boiler 4)	-	0	1	0	Type of run indication 0 = Motor protection 1 = Run indication Only visible if HB4 Return Limitation Type = 1	Configuration ► HB ► Boiler pumps ► HB4 ►
Return-Pump Delay (Boiler 4)	s	0	200	10	Delay time of the pump indication.	Configuration ► HB ► Boiler pumps ► HB4 ►
Return Temp SetP (Boiler 4)	°C	0	100	40		HB ► Actual/ Setpoint ► HB4 ►
Boiler 4 Return Temp P-Band/Hyst	°C	0	50	10		HB ► Temp control ►

3.7.8 Boiler pump

Each boiler has an individual circulation pump. When there is a heating requirement, and before a burner can start, its circulation pump will start up and run for 30 seconds (settable), after which the burner will be permitted to start. When stopping, the burner will stop first, and then the pump will stop after a set shutdown delay.

Pumps are exercised for 5 minutes at 3 pm daily (settable).

Parameters

Name	Unit	Min	Max	Default	Description	Menu path
Run Time Before Start of HB	s	0	255	30	Runtime of the pump before the boiler starts.	Configuration ► HB ► Boiler pumps ► Boiler pump (s) ►
Run Time After Stop	s	0	255	30	Extended runtime of the pump.	Configuration ► HB ► Boiler pumps ► Boiler pump (s) ►
Pump Exercise Hour		0	23	15	Start time of the exercise.	Configuration ► HB ► Boiler pumps ► Boiler pump (s) ►
Pump Exercise Time	min	0	255	5	Duration of the exercise.	Configuration ► HB ► Boiler pumps ► Boiler pump (s) ►
Pump Type (Boiler 1)	-	0	1	0	Type of pump 0 = Single pump 1 = Double pump	Configuration ► HB ► Boiler pumps ► HB1 ►
Pump Ind (Boiler 1)	-	0	1	0	Type of run indication 0 = Motor protection 1 = Run indication	Configuration ► HB ► Boiler pumps ► HB1 ►
Pump Delay (Boiler 1)	s	0	200	10	Delay time of the pump indication.	Configuration ► HB ► Boiler pumps ► HB1 ►
Pump Runtime (Boiler 1)	h	0	1000	100	Runtime of the pump, only used for double pumps.	Configuration ► HB ► Boiler pumps ► HB1 ►
Pump Type (Boiler 2)	-	0	1	0	Type of pump 0 = Single pump 1 = Double pump	Configuration ► HB ► Boiler pumps ► HB2 ►
Pump Ind (Boiler 2)	-	0	1	0	Type of run indication 0 = Motor protection 1 = Run indication	Configuration ► HB ► Boiler pumps ► HB2 ►
Pump Delay (Boiler 2)	s	0	200	10	Delay time of the pump indication.	Configuration ► HB ► Boiler pumps ► HB2 ►
Pump Runtime (Boiler 2)	h	0	1000	100	Runtime of the pump, only used for double pumps.	Configuration ► HB ► Boiler pumps ► HB2 ►
Pump Type (Boiler 3)	-	0	1	0	Type of pump 0 = Single pump 1 = Double pump	Configuration ► HB ► Boiler pumps ► HB3 ►
Pump Ind (Boiler 3)	-	0	1	0	Type of run indication 0 = Motor protection 1 = Run indication	Configuration ► HB ► Boiler pumps ► HB3 ►
Pump Delay (Boiler 3)	s	0	200	10	Delay time of the pump indication.	Configuration ► HB ► Boiler pumps ► HB3 ►
Pump Runtime (Boiler 3)	h	0	1000	100	Runtime of the pump, only used for double pumps.	Configuration ► HB ► Boiler pumps ► HB3 ►
Pump Type (Boiler 4)	-	0	1	0	Type of pump 0 = Single pump 1 = Double pump	Configuration ► HB ► Boiler pumps ► HB4 ►
Pump Ind (Boiler 4)	-	0	1	0	Type of run indication 0 = Motor protection 1 = Run indication	Configuration ► HB ► Boiler pumps ► HB4 ►
Pump Delay (Boiler 4)	s	0	200	10	Delay time of the pump indication.	Configuration ► HB ► Boiler pumps ► HB4 ►
Pump Runtime (Boiler 4)	h	0	1000	100	Runtime of the pump, only used for double pumps.	Configuration ► HB ► Boiler pumps ► HB4 ►

3.7.9 Transport pump

The boiler control has a common transport pump. It can be configured either as a single pump (pump A) or as a double pump (pump A and pump B). The pump will start when a burner is active, or if the outdoor temperature drops beneath 18°C (settable). Should an alarm occur in the transport pump, all burners will stop and remain blocked until the alarm has been reset and acknowledged. If the system has been configured as a double pump, it will automatically switch from transport pump A to transport pump B and vice versa, should an alarm occur.

It is also possible to use a digital input for pressure/flow indication. When the transport pump is running, a missing signal will generate an alarm and all boilers will be stopped.

The pump is exercised daily at 3 PM for 5 minutes. If the transport pump has been configured as a double pump, both pumps are exercised.

Parameters

Name	Unit	Min	Max	Default	Description	Menu path
Pump Type	-	0	1	0	Type of pump 0 = Single pump 1 = Double pump	Configuration ► HB ► Boiler pumps ► Transport pump ►
Pump Ind	-	0	1	0	Type of run indication 0 = Motor protection 1 = Run indication	Configuration ► HB ► Boiler pumps ► Transport pump ►
Pump Delay	s	0	200	10	Delay time of the pump indication.	Configuration ► HB ► Boiler pumps ► Transport pump ►
Pump Runtime	h	0	1000	100	Runtime of the pump, only used for double pumps.	Configuration ► HB ► Boiler pumps ► Transport pump ►
Outd Temp for Start of Pump	°C	-40	50	18		Configuration ► Boiler ► Boiler pumps ► Transport pump ►
Hyst for Start/Stop of Pump	°C	1	20	5		Configuration ► Boiler ► Boiler pumps ► Transport pump ►

3.7.10 Manual mode

Setting parameters to manual mode is a very useful feature during commissioning or when troubleshooting.



Caution! Leaving any output in manual control means that the normal control will be suspended. Therefore, an alarm will be generated as soon as any output is set to any mode other than **Auto**.

The following parameters can be set to manual mode for the boilers:

Parameters

Name	Unit	Min	Max	Default	Description	Menu path
Manual/Auto Modulating Boiler	-	0	2	Auto	0 = Manual-Off 1 = Manual 2 = Auto	HB ► Manual/Auto ► HB ►
Manual/Auto Manual Set	%	0	100	-	0-100%	HB ► Manual/Auto ► HB ►

Name	Unit	Min	Max	Default	Description	Menu path
HB1 Manual/Auto Boiler	-	0	3	Auto	0 = Off 1 = Low 2 = High 3 = Auto	HB► Manual/Auto ► HB1 ►
HB1 Manual/Auto Pump	-	0	3	Auto	0 = Off 1 = Pump A On 2 = Pump B On 3 = Auto	HB► Manual/Auto ► HB1 ►
HB1 Manual/Auto Return Temp Valve	-	0	2	Auto	0 = Off 1 = Manual 2 = Auto	HB► Manual/Auto ► HB1 ►
HB1 Manual/Auto Manual Set	%	0	100	-	0-100%	HB► Manual/Auto ► HB1 ►
HB1 Manual/Auto Return Temp Pump	-	0	2	Auto	0 = Off 1 = Pump 2 = Auto	HB► Manual/Auto ► HB1 ►
HB2 Manual/Auto Boiler	-	0	3	Auto	0 = Off 1 = Low 2 = High 3 = Auto	HB► Manual/Auto ► HB2 ►
HB2 Manual/Auto Pump	-	0	3	Auto	0 = Off 1 = Pump A On 2 = Pump B On 3 = Auto	HB► Manual/Auto ► HB2 ►
HB2 Manual/Auto Return Temp Valve	-	0	2	Auto	0 = Off 1 = Manual 2 = Auto	HB► Manual/Auto ► HB2 ►
HB2 Manual/Auto Manual SetP	%	0	100	-	0-100%	HB► Manual/Auto ► HB2 ►
HB2 Manual/Auto Return Temp Pump	-	0	2	Auto	0 = Off 1 = Pump 2 = Auto	HB► Manual/Auto ► HB2 ►
HB3 Manual/Auto Boiler	-	0	3	Auto	0 = Off 1 = Low 2 = High 3 = Auto	HB► Manual/Auto ► HB3 ►
HB3 Manual/Auto Pump	-	0	3	Auto	0 = Off 1 = Pump A On 2 = Pump B On 3 = Auto	HB► Manual/Auto ► HB3 ►
HB3 Manual/Auto Return Temp Valve	-	0	2	Auto	0 = Off 1 = Manual 2 = Auto	HB► Manual/Auto ► HB3 ►
HB3 Manual/Auto Manual SetP	%	0	100	-	0-100%	HB► Manual/Auto ► HB3 ►
HB3 Manual/Auto Return Temp Pump	-	0	2	Auto	0 = Off 1 = On 2 = Auto	HB► Manual/Auto ► HB3 ►
HB4 Manual/Auto Boiler	-	0	3	Auto	0 = Off 1 = Low 2 = High 3 = Auto	HB► Manual/Auto ► HB4 ►
HB4 Manual/Auto Pump	-	0	3	Auto	0 = Off 1 = Pump A On 2 = Pump B On 3 = Auto	HB► Manual/Auto ► HB4 ►

Name	Unit	Min	Max	Default	Description	Menu path
HB4 Manual/Auto Return Temp Valve	-	0	2	Auto	0 = Off 1 = Manual 2 = Auto	HB► Manual/Auto ► HB4 ►
HB4 Manual/Auto Manual SetP	%	0	100	-	0-100%	HB► Manual/Auto ► HB4 ►
HB4 Manual/Auto Return Temp Pump	-	0	2	Auto	0 = Off 1 = On 2 = Auto	HB► Manual/Auto ► HB4 ►
Manual/Auto Pump	-	0	3	Auto	0 = Off 1 = Pump A On 2 = Pump B On 3 = Auto	HB► Manual/Auto ► Transport pump ►

3.8 Pump control

Function to control a single or a double pump depending on the demand. This chapter is a general description of the pump control function. Configuration of the pumps are done within the other functions.

The function provides following features:

- ✓ Change between pump A and B after a settable difference of runtime or an alarm at the running pump
- ✓ Alarm can be a signal from a motor-protection or a missing feedback
- ✓ Delay time for the error detection
- ✓ Feedback can work with one or two inputs

3.8.1 Inputs and outputs

The following inputs and outputs are used for the pump control function.

Digital inputs

Name	Unit	Description
Input	-	Control signal to start / stop the pump
Feedback Pump A	-	Feedback from pump A depending on the type of feedback. Motor protection: 0 = Okay 1 = Error Run indication: 0 = Off 1 = Running
Feedback Pump A assigned	-	Signal Feedback pump A is configured
Feedback Pump B	-	Feedback from pump A depending on the type of feedback. Motor protection: 0 = Okay 1 = Error Run indication: 0 = Off 1 = Running
Feedback Pump B assigned	-	Signal Feedback pump B is configured
Exercise running	-	Exercise took over the control of the pump

Digital outputs

Name	Unit	Description
Pump A	Off/On	
Pump B	Off/On	
Manual State	Off/On	Pump function is in manual mode
Alarm Pump A	Off/On	
Alarm Pump B	Off/On	

3.8.2 Parameters

Name	Unit	Min	Max	Default	Description	Menu path
Pump Type	-	0	1	0	Type of pump 0= Single pump 1 = Double pump	Configuration ► HS ► HS1 ► System ►
Pump Ind	-	0	1	0	Type of feedback for the load pump. 0 = motor protection 1 = run indication	Configuration ► HS ► HS1 ► System ►
Pump Delay	s	0	200	10	Delay time of the pump indication.	Configuration ► HS ► HS1 ► System ►
Pump Runtime	h	0	1000	100	Runtime of the pump, only used for double pumps.	Configuration ► HS ► HS1 ► System ►
Manual/Auto Pump PumpA	-	0	2	Auto	0 = Off 1 = On 2 = Auto	HS1 ► Manual/Auto ►
Manual/Auto Pump PumpB	-	0	2	Auto	0 = Off 1 = On 2 = Auto	HS1 ► Manual/Auto ►

3.9 General functions

The general functions menu contains three different items:

- ✓ Building inertia
- ✓ Split valve
- ✓ Priority

3.9.1 Building inertia

Every building has the capacity to store energy. The amount of energy that a building can store is described in the **Building inertia** parameter. This value is dependent on the construction of the building (e.g. the thickness of its outdoor walls, insulation, type of windows, etc.).

If **Building inertia** is activated (value > 0), the outdoor temperature will be delayed by this value. The delayed outdoor temperature will then be used instead of the real value.

Parameters

Name	Unit	Min	Max	Default	Description	Menu path
Building inertia	h	0.0	24.0	0.0	Delay of the outdoor temperature.	Configuration ► General functions ► Heating ►

3.9.2 Split valve

The signal of an actuator can be split to two different outputs. The controller output 0% – **Split point** is sent to the main output (HSx/HWx actuator) and **Split point** – 100% is sent to the split output.

Any of the signals HS1, HS2, HS3, HS4, HW1, HW2 or DHS1 can be split in two.

Parameters

Name	Unit	Min	Max	Default	Description	Menu path
Split Valve	-	0	7	0	0 = No split 1 = HS1 2 = HS2 3 = HS3 4 = HS4 5 = HW1 6 = HW2 7 = DHS1	Configuration ► General functions ► Heating ►
Split point	%	0	100	50		Configuration ► General functions ► Heating ►
Runtime	s	0	600	120	Actuator runtime if connected to an increase/decrease output.	Configuration ► General functions ► Heating ►

3.10 Priority

Function for prioritizing the domestic hot water circuits over the heating system circuits or vice versa. This can be useful for example in a system that is somewhat undersized when it is very cold outside. The configuration parameters for the Priority function can be found in the **General functions** menu.

3.10.1 Priority function

The *Priority* function permits defining if and how the HW circuits should have priority over the heating systems or the other way around, when heat is required. This function is needed when the heat producer is unable to simultaneously supply heat to all heat consumers. Therefore, it is possible to define a reduction of the reduced circuit.

There are two types of priority:

- ✓ If there is a deviation / load in one of the assigned HW's (parameter **HW1** or **HW2**) the function starts to reduce the assigned HS's (parameter **HS1**, **HS2**, **HS3** and **HS4**)
- ✓ If there is a deviation in one of the assigned HS's (parameter **HS1**, **HS2**, **HS3** or **HS4**) the function starts to reduce the assigned HW's (parameter **HW1** and **HW2**)

The function only works with heating systems which are not in *Cooling* mode (inputs **Cooling HSx** must be 0)

If the function has to reduce something, the timer **DelayTime** starts.

If the timer **DelayTime** expires, the function sends out the reduction signals to the HS's (when **Activation Direction** = 1) or to the HW's (when **Activation Direction** = 2).

The timer **MaxTime** starts and the following signals are sent out to the circuits which have to be reduced:

- ✓ **Type** = 1: Sent out: Status = 1
- ✓ **Type** = 2: Sent out: Status = 2

If the timer **MaxTime** expires, the system goes back to “parallel” mode (no reduction, **Status HSx /Status HWx = 0**) and the timer **MaxTime** starts again.

If the timer **MaxTime** expires again, the function starts again from the beginning.

Parameters

Name	Unit	Min	Max	Default	Description	Menu path
Activation Direction	-	0	2	0	Activates or deactivates the <i>Priority</i> function. 0 = Not active 1 = HW's are prioritized 2 = HS's are prioritized	Configuration ► General functions ► Priority ►
Type	-	1	2	1	1 = Absolute (off) 2 = Reduced NCT (reduced circuits works with setpoint NCT)	Configuration ► General functions ► Priority ►
MaxDeviation	°C	0.1	50.0	2.0	Max deviation to start the function.	Configuration ► General functions ► Priority ►
Working on HS1	-	0	1	1	HS1 will be influenced by / will influence the priority function.	Configuration ► General functions ► Priority ►
Working on HS2	-	0	1	1	HS2 will be influenced by / will influence the priority function.	Configuration ► General functions ► Priority ►
Working on HS3	-	0	1	1	HS3 will be influenced by / will influence the priority function.	Configuration ► General functions ► Priority ►
Working on HS4	-	0	1	1	HS4 will be influenced by / will influence the priority function.	Configuration ► General functions ► Priority ►
Working on HW1	-	0	1	1	HW1 will be influenced by / will influence the priority function.	Configuration ► General functions ► Priority ►
Working on HW2	-	0	1	1	HW2 will be influenced by / will influence the priority function.	Configuration ► General functions ► Priority ►
DelayTime	min	0	60	30	Delay of the reduction.	Configuration ► General functions ► Priority ►
DelayTime Timer	min				The current value of the DelayTime timer.	Configuration ► General functions ► Priority ►
MaxTime	min	0	600	120	Max time of the reduction.	Configuration ► General functions ► Priority ►
MaxTime Timer	min				The current value of the MaxTime timer.	Configuration ► General functions ► Priority ►

3.11 Refill

Automatic refill of the system in case of low pressure. Limitation of the refill time and the time between two cycles. Needs either an AI or DI and DO.

3.1.1.1 Inputs and outputs

The following inputs and outputs are used for the refill function.

Analogue inputs

Name	Unit	Description
Pressure	bar	The pressure in the system.

Digital inputs

Name	Unit	Description
Low Pressure	Off/On	

Digital outputs

Name	Unit	Description
Refill	Off/On	Output to refill the system.

3.1.1.2 Function

In case of **Low Pressure (DI)** or **Pressure (AI) < Min pressure**, the function starts to refill the system by activation of the **DO Refill**.

The refill ends if:

- ✓ **Low Pressure** is On again
- ✓ **Pressure > Min Pressure + Hysteresis**
- ✓ Output **Refill** is active for **Duration of refill cycles**

The maximum number of refill cycles is limited by the parameter **Max number of cycles**. The time between two cycles of refill must be higher than **Time between refill cycles**. The cycle counter can be reset by the parameter **Reset**.

Parameters

Name	Unit	Min	Max	Default	Description	Menu path
Min pressure	bar	0.0	10.0	2.0		Configuration ► General functions ► Refill ►
Hysteresis	bar	0.0	10.0	0.1		Configuration ► General functions ► Refill ►
Max number of cycles	-	1	10	1	Number of refill cycles.	Configuration ► General functions ► Refill ►
Time between refill cycles	min	0	600	60		Configuration ► General functions ► Refill ►
Duration of refill cycles	s	0	600	30		Configuration ► General functions ► Refill ►
Reset	-	0	1	0	Reset of duration counter.	Configuration ► General functions ► Refill ►

3.12 Energy / Cold water monitoring

The controller can be configured to monitor the energy or water consumption. Digital pulse inputs can be configured for monitoring the consumption as well as M-Bus meters.

3.12.1 Inputs and outputs

The following inputs and outputs are used for the energy/cold water monitoring function.

Digital inputs

Name	Unit	Description
Heating system 1 energy pulse	-	Digital pulse input to count the pulses from the meter of HS1.
Heating system 2 energy pulse	-	Digital pulse input to count the pulses from the meter of HS2.
Heating system 3 energy pulse	-	Digital pulse input to count the pulses from the meter of HS3.
Heating system 4 energy pulse	-	Digital pulse input to count the pulses from the meter of HS4.
Domestic hot water 1 energy pulse	-	Digital pulse input to count the pulses from the meter of HW1.
Domestic hot water 2 energy pulse	-	Digital pulse input to count the pulses from the meter of HW2.
District heating energy pulse	-	Digital pulse input to count the pulses from the meter of DHS1.
Water pulse	-	Digital pulse input to count the pulses from the heat-water-meter.
Energy pulse	-	Digital pulse input to count the pulses from the heat-energy-meter.
Cold water 1 pulse	-	Digital pulse input to count the pulses from the cold water meter 1.
Cold water 2 pulse	-	Digital pulse input to count the pulses from the cold water meter 2.
Electric pulse	-	Digital pulse input to count the pulses from the electrical meter.

3.12.2 Pulse meter

One digital input can be configured to monitor the energy consumption of each circuit separately. The pulse constant is settable and the maximum pulse rate is 2 Hz. There are 4 additional inputs to monitor the volume of 3 water meters (**Volume pulse**, **Cold water 1 pulse**, **Cold water 2 pulse**) and the consumption of electrical energy (**Electric pulse**).

Parameters

Configuration of the pulse meters is done by setting the right pulse constant of the connected meters.

Name	Unit	Min	Max	Default	Description	Menu path
Energy Pulse Heating	kWh/ pulse	0	10000	1	Pulse constant of the heat energy meter.	Configuration ► General functions ► Pulse constants ►
Volume Pulse Heating	l/pulse	0	10000	10	Pulse constant of the heat water meter.	Configuration ► General functions ► Pulse constants ►
Energy Pulse HS1	kWh/ pulse	0	10000	1	Pulse constant of energy meter Heating system 1.	Configuration ► General functions ► Pulse constants ►
Energy Pulse HS2	kWh/ pulse	0	10000	1	Pulse constant of energy meter Heating system 2.	Configuration ► General functions ► Pulse constants ►
Energy Pulse HS3	kWh/ pulse	0	10000	1	Pulse constant of energy meter Heating system 3.	Configuration ► General functions ► Pulse constants ►

Name	Unit	Min	Max	Default	Description	Menu path
Energy Pulse HS4	kWh/ pulse	0	10000	1	Pulse constant of energy meter Heating system 4.	Configuration ► General functions ► Pulse constants ►
Energy Pulse HW1	kWh/ pulse	0	10000	1	Pulse constant of energy meter Domestic hot water 1.	Configuration ► General functions ► Pulse constants ►
Energy Pulse HW2	kWh/ pulse	0	10000	1	Pulse constant of energy meter Domestic hot water 2.	Configuration ► General functions ► Pulse constants ►
Energy Pulse DHS1	kWh/ pulse	0	10000	1	Pulse constant of energy meter District heating system.	Configuration ► General functions ► Pulse constants ►
Electric Meter	kWh/ pulse	0	10000	1	Pulse constant of electricity meter.	Configuration ► General functions ► Pulse constants ►
Cold Water1	l/pulse	0	10000	10	Pulse constant of Cold water meter 1.	Configuration ► General functions ► Pulse constants ►
Cold Water2	l/pulse	0	10000	10	Pulse constant of Cold water meter 2.	Configuration ► General functions ► Pulse constants ►

Meter data

Depending on the kind of meter, the following parameters will be calculated by the controller. The heating power is calculated by measuring the time between energy pulses.

Energy meter

Name	Unit	Min	Max	Default	Description	Menu path
HSx/HWx/DHS1 Energy Total	MWh	0	10000-00	0	Total energy consumption, can be reset.	Energy/Cold water ► Energy HSx/HWx/DHSx ►
HSx/HWx/DHS1 Energy Today	kWh	-	-	-	24h usage, today.	Energy/Cold water ► Energy HSx/HWx/DHSx ►
HSx/HWx/DHS1 Energy Yesterday	kWh	-	-	-	24h usage, yesterday.	Energy/Cold water ► Energy HSx/HWx/DHSx ►
HSx/HWx/DHS1 Energy D B Y-day	kWh	-	-	-	24h usage, day before yesterday.	Energy/Cold water ► Energy HSx/HWx/DHSx ►
HSx/HWx/DHS1 Power Instant	kW	-	-	-	Instantaneous power.	Energy/Cold water ► Energy HSx/HWx/DHSx ►
HSx/HWx/DHS1 Power Average	kW	-	-	-	Average of the instantaneous power for the last hour.	Energy/Cold water ► Energy HSx/HWx/DHSx ►
HSx/HWx/DHS1 Power Max Aver	kW	-	-	-	Maximum average value of the instantaneous power.	Energy/Cold water ► Energy HSx/HWx/DHSx ►

Heat meter

Name	Unit	Min	Max	Default	Description	Menu path
Energy Total	MWh	0	10000-00	0	Total energy consumption, can be reset.	Energy/Cold water ► Heat meter ►
Hot water total	m ³	0	10000-00	0	Total water consumption, can be reset.	Energy/Cold water ► Heat meter ►

Name	Unit	Min	Max	Default	Description	Menu path
Energy Today	kWh	-	-	-	24h usage, today.	Energy/Cold water ► Heat meter ►
Energy Yesterday	kWh	-	-	-	24h usage, yesterday.	Energy/Cold water ► Heat meter ►
Energy D B Y-day	kWh	-	-	-	24h usage, day before yesterday.	Energy/Cold water ► Heat meter ►
Consumption Today	l	-	-	-	24h consumption, today.	Energy/Cold water ► Heat meter ►
Consumption Yesterday	l	-	-	-	24h consumption, yesterday.	Energy/Cold water ► Heat meter ►
Consumption D B Y-day	l	-	-	-	24h consumption, day before yesterday.	Energy/Cold water ► Heat meter ►
Power Consumption Instant	kW	-	-	-	Instantaneous power consumption.	Energy/Cold water ► Heat meter ►
Power Consumption Average	kW	-	-	-	Average of the instantaneous power consumption for the last hour.	Energy/Cold water ► Heat meter ►
Power Consumption Max Aver	kW	-	-	-	Maximum average value of the instantaneous power consumption.	Energy/Cold water ► Heat meter ►

Cold water meter

Name	Unit	Min	Max	Default	Description	Menu path
CWx Consump Total	m³	0	10000-00	0	Total water consumption, can be reset.	Energy/Cold water ► Cold water meterx ►
CWx Flow	l/min	-	-	-	Water flow.	Energy/Cold water ► Cold water meterx ►
CWx Consump Today	l	-	-	-	24h usage, today.	Energy/Cold water ► Cold water meterx ►
CWx Consump Yesterday	l	-	-	-	24h usage, yesterday.	Energy/Cold water ► Cold water meterx ►
CWx Consump D B Y-day	l	-	-	-	24h usage, day before yesterday.	Energy/Cold water ► Cold water meterx ►
Lowest CWx Consump Today	l	-	-	-	Lowest hourly usage today.	Energy/Cold water ► Cold water meterx ►
Lowest CWx Consump Yesterday	l	-	-	-	Lowest hourly usage yesterday.	Energy/Cold water ► Cold water meterx ►

Electricity meter

Name	Unit	Min	Max	Default	Description	Menu path
Energy Total	MWh	0	10000-00	0	Total energy consumption, can be reset.	Energy/Cold water ► Electricity meter ►

Alarms

Alarms are generated for the main energy meter and the cold water meters. For more information about these alarms, see the full alarm list in *Appendix D Alarm list*.

Name	Description
Pulse error	If no pulses are detected within a settable time, an alarm is activated. Setting the time to 0 inhibits the alarm function.
High usage	If the daily usage is higher than a settable value an alarm is activated.

3.12.3 M-Bus meter

M-bus meters can be connected to a serial port of the controller via an M-Bus to serial converter X1176 or to the built-in M-Bus interface if the controller has one.

Up to 7 M-bus meters can be configured to monitor the energy consumption of the Heating systems, Domestic hot water systems and the District heating system.

In addition, two M-bus meters can be configured to monitor the water consumption, Water meter 1 and Water meter 2.

Parameters

Name	Unit	Min	Max	Default	Description	Menu path
Heat Meter	Off/On	0	1	Off	Activation of the meter 0 = Off 1 = On	Configuration ► Communication ► Function port M-Bus ► Heat meter HSx/ HWx/DHSx ►
Address	-	0	255	1-7	Bus-address of the meter. Default addresses: HS1 = 1 HS2 = 2 HS3 = 3 HS4 = 4 HW1 = 5 HW2 = 6 DHS1 = 7	Configuration ► Communication ► Function port M-Bus ► Heat meter HSx/ HWx/DHSx ►
Interval	-	0	4	1	Interval to read out the meter: 0 = Always 1 = 15 minutes 2 = 30 minutes 3 = 1 hour 4 = 24 hours	Configuration ► Communication ► Function port M-Bus ► Heat meter HSx/ HWx/DHSx ►
Water Meter	Off/On	0	1	Off	Activation of the meter 0 = Off 1 = On	Configuration ► Communication ► Function port M-Bus ► Water meter ► Water meterx ►
Address	-	0	255	8-9	Bus-address of the meter. Default addresses: Water meter 1 = 8 Water meter 2 = 9	Configuration ► Communication ► Function port M-Bus ► Water meter ► Water meterx ►
Interval	-	0	4	1	Interval to read out the meter: 0 = Always 1 = 15 minutes 2 = 30 minutes 3 = 1 hour 4 = 24 hours	Configuration ► Communication ► Function port M-Bus ► Water meter ► Water meterx ►

Meter data

Depending on the meter, the following parameters can be read:

Name	Unit	Min	Max	Default	Description	Menu path
Temperature Supply	°C	-	-	-	Supply temperature.	Energy/Cold water ► HM HSx/HWx/DHSx ►
Temperature Return	°C	-	-	-	Return temperature.	Energy/Cold water ► HM HSx/HWx/DHSx ►

Name	Unit	Min	Max	Default	Description	Menu path
Delta-T	°C	-	-	-	Temperature difference between supply and return.	Energy/Cold water ► HM HSx/HWx/DHSx ►
Energy	MWh	-	-	-	Total energy consumption.	Energy/Cold water ► HM HSx/HWx/DHSx ►
Power	kW	-	-	-	Instantaneous power.	Energy/Cold water ► HM HSx/HWx/DHSx ►
Volume	m ³	-	-	-	Total water volume.	Energy/Cold water ► HM HSx/HWx/DHSx ►
Flow	l/min	-	-	-	Water flow.	Energy/Cold water ► HM HSx/HWx/DHSx ►

Alarms

Each M-Bus meter can generate an alarm if the communication is broken. For more information about these alarms, see the full alarm list in *Appendix D Alarm list*.

3.13 Pressure control

The signal of an analogue output can be controlled to maintain a constant pressure.

3.13.1 Inputs and outputs

The following inputs and outputs are used for the pressure control function.

Analogue inputs

Name	Unit	Description
Differential pressure	kPa	Input signal from the pressure sensor

Analogue outputs

Name	Unit	Description
Diff pressure valve	%	Control signal of the frequency converter

Digital outputs

Name	Unit	Description
Frequency converter start	Off/On	Start signal to the frequency converter

3.13.2 Setpoint

The **Actual/Setpoint** menu shows the calculated setpoints.

Parameters

Name	Unit	Min	Max	Default	Description	Menu path
Pressure control SetP	kPa	0.0	10000.-0	50.0	Setpoint to be controlled by the PI-controller.	Pressure control ► Actual/Setpoint ►

3.13.3 Control pressure

The **Control pressure** menu permits the configuration of the PI-controller.

A digital output signal can be used to give a start signal to the frequency converter. This output is enabled as soon as the converter control signal rises above 0.1 V.

Parameters

Name	Unit	Min	Max	Default	Description	Menu path
P-band	kPa	1	1000	25	P-band pressure control.	Pressure control ► Control pressure ►
I-time	s	0	9999	100	I-time pressure control.	Pressure control ► Control pressure ►
Min Output	%	0	100	0	Minimum output of the PI-controller.	Pressure control ► Control pressure ►

3.14 Inputs/outputs

```
AI/UAI
WAI
DI/UDI
AO
DO
```

3.14.1 General

Free configuration

Any control signal can be bound to any input/output. The only restriction is that digital signals cannot be bound to analogue inputs and vice versa. It is up to the user doing the binding to make sure that activated functions are bound to appropriate in- and outputs.

Analogue inputs, AI/UAI

```
AI1 Raw: -4.5
Outdoor temp
Compensation: 0.0 °C
Sensor type: PT1000
```

All analogue inputs are for PT1000, Ni1000 or 0...10 V.

Input signals can be compensated, e.g. for wiring resistance.

The raw value will show the actual, uncompensated input value.

If input type is set to 0...10 V, the parameter values that should correspond to the input signal levels 0 V and 10 V can be set.

```
Sensor type
0 V = 0
10 V = 100
```

Wireless inputs, WAI

```
WAI1 Raw:-4.5
Outdoor temp
Compensation: 0.0 °C
Sign: 0 Bat:Ok
```

Wireless input signals can be compensated.

The raw value will show the actual, uncompensated input value.

Sign shows the strength of the wireless signal. **Bat** shows if the battery is low.

Connecting wireless sensors

Menu to connect/disconnect a wireless sensor with the receiver. Select the wireless sensor and the **Action** can be changed; *No action/Connect/Disconnect*. For more information, see the documentation for the wireless sensors.

```
Connect/Disconnect
WAI: 1
Action: No action
```

Digital inputs, DI/UDI

```
DI1 Status:Off
HS1 Pump A ind
NO/NC:NO
```

To simplify adaptation to external functions, all digital inputs can be set to be either normally open, NO, or normally closed, NC.

The digital inputs are set to normally open as default, i.e. if the input is closed, the function connected to the input is activated.



Caution! Be careful when changing the input from NO to NC, since some digital functions can be configured to either NO or NC themselves.

Analogue outputs, AO

```
AO1 Value: 10.0V
HS1 Actuator
Manual/Auto:Auto
```

Analogue outputs are 0...10 V DC.

Analogue outputs can be set to run mode **Auto**, **Manual** or **Off**. If they are set to **Manual** mode, the **AOx** value can be changed.

Digital outputs, DO

```
DO1 Status:On
HS1 Pump A Start
Man/Auto:Auto
```

Digital outputs can be set to run mode **Auto**, **Manual-On** or **Manual-Off**.

3.15 Alarm settings

The alarm settings menu has two submenus, **Alarm limits** and **Alarm delay**. In these submenus, the alarm limits and alarm delays are configured for all alarms. They contain limits and delays for the following alarms:

3.15.1 Alarm limits

- ✓ Control deviation HS1, HS2, HS3 and HS4
- ✓ Control deviation HW1 and HW2
- ✓ High temperature limit HW1 and HW2
- ✓ High temperature limit DHS1
- ✓ Solar collector max temperature
- ✓ Solar collector frost limit
- ✓ High temperature buffer tank
- ✓ High temperature boiler
- ✓ Low temperature boiler
- ✓ High supply temperature boiler 1-4
- ✓ High water consumption 24 hours
- ✓ High water consumption 1 hour
- ✓ High energy consumption 24 hours
- ✓ Maximum time between pulses

3.15.2 Alarm delays

- ✓ Control deviation HS1, HS2, HS3 and HS4
- ✓ Control deviation HW1 and HW2
- ✓ High temperature limit HW1 and HW2
- ✓ High temperature boiler
- ✓ Low temperature boiler
- ✓ Expansion vessel
- ✓ External alarm

3.16 Alarm configuration

The Alarm config menu permits configuration of the priority for all alarms. A complete alarm list can be found in *Appendix D Alarm list*. It contains all the default alarm texts and priorities.

3.16.1 Priority

The alarm priority that is shown in the display in the event of an alarm can only be changed using Exigo tool. For more information, see the Exigo tool manual.

3.16.2 Alarm text

The alarm text that is shown in the display in the event of an alarm can only be changed using Exigo tool. For more information, see the Exigo tool manual.

3.17 Communication

The Communication menu contains settings for Function port 1 and 2, Function port M-Bus and TCP/IP.

The controller is capable of communication via the BACnet protocol, using either IP or MS/TP data link formats. In order to connect a controller to a BAS (Building Automation System) via BACnet/IP, a controller with a TCP/IP port is required. To connect to a BAS via BACnet MS/TP, a controller with an RS485 communication port is required.

3.17.1 Serial port 1 and 2

In a controller with two serial ports, both ports have the same functions. However, they can not both be configured to have the same function at the same time, except that both can be slaves.

Four different types of communication can be selected:

- ✓ Slave
- ✓ Expansion unit
- ✓ Wireless sensors
- ✓ M-Bus

```
Function port1
Slave
```

Slave

For connection to Exigo tool or a SCADA system.

```
Function port1
Slave
```

The default protocol in slave-mode is EXOline. The communication protocol can be changed to Modbus or BACnet MS/TP.

Modbus

To connect the controller to a network for Modbus communication, the Modbus-slave must be activated.

```
Modbus
communication
Slave, port 1
Not Active
```

If Modbus communication is activated, you can set the address etc.

```
Modbus address: 1
Speed: 9600 bps
Two stop bits:No
Parity:No
```

BACnet MS/TP

To connect the controller to a BACnet MS/TP network, the BACnet MS/TP of the port must be activated. The default communication settings upon delivery are as follows:

- ✓ Speed = 9600 bps
- ✓ MAC address = 0
- ✓ Device ID = 2640
- ✓ Max Master = 127

```
Function port1
Slave
```

```
BACnet MS/TP
communication
port1
Active
```

```
Device name
Exigo
MAC
0
```

```
Device ID low
2640
Device ID high
0 (x10000)
```

```
Speed
9600 bps
Max master address
127
```

Device name

This is the name of the device, as shown on the BAS when discovering devices.

MAC

The MAC address of the device. This needs to be unique only to the subnet to which the device is attached.

Device ID

The ID of a device, used to identify it on the BACnet network. To set an ID value of 34600, the low number would be set to 4600 and the high number to 3.



Note! The ID number must be unique, and can not be duplicated anywhere on the BACnet network.

Speed

Sets the communication speed of the MS/TP network. This value can be 9600, 19200, 38400 or 76800, but is typically set to 38400 or 76800.

Max master address

The max master address is the MAC address of the highest master device on the BACnet MS/TP network segment. Setting this number above the highest MAC address will decrease network performance.

For additional information, see the Exigo PICS document available at <http://www.bacnetinternational.net/btl/index.php?m=133>.

Expansion unit

In order to connect additional inputs and outputs to the controller, port 1 or 2 should be set as **Expansion unit + External sensor** (IO-expansion units IO-A15MIXW-3-BEM, IO-A28MIXW-3-BEM, IO-V19MIXW-1-BEM or controllers configured as expansion units can be connected). It is possible to connect two expansion units, giving a maximum number of $28 \times 3 = 84$ inputs/outputs. The expansion units must have the addresses 241:1 and 241:2 respectively (PLA:ELA).

```
Function port1
Exp unit
```

```
Expansion unit1
None
Expansion unit2
None
```

To initiate the expanded controllers, select **Expansion unit** at start-up (see below). After initiating the expansion units and setting the master controller, all inputs and outputs are available for configuration in the master controller under **Configuration ▶ Inputs/Outputs ▶** (the inputs/outputs of the expansion units are named Exp1/Exp2).

```
Expansion unit1
Expansion unit2
```

Wireless sensor

In order to connect additional wireless sensors to the controller, port 1 or 2 should be configured as **Wireless sensor + Modbus pumps**. Up to 16 sensors (outdoor sensors and room sensors), can be connected via the wireless receiver.

The room sensors can be connected to an average function (**HSx Room Temp Aver.**). The result of the average calculation is used as room temperature in the chosen heating system. Different kind of calculations are selectable at **Configuration ▶ Inputs/Outputs ▶ WAI ▶ Type of average calc:**

- ✓ Minimum
- ✓ Maximum
- ✓ Average
- ✓ Average without lowest and highest value
- ✓ Median filter

The communication to the wireless receiver needs to be activated under **Configuration ▶ Communication ▶ Function port x ▶ Wireless Sensor**.

After the port is set to **Wireless sensor**, all inputs are available for configuration in the master controller under **Configuration ▶ Inputs/Outputs ▶** (the wireless inputs are named WAI).

Modbus pumps

In order to connect modbus pumps to the controller, port 1 or 2 should be configured as **Wireless sensor + Modbus pumps**. Up to 10 pumps can be connected.

The communication to the pumps needs to be activated under **Configuration ▶ Communication ▶ Function port x ▶ Modbus Pumps**

The type of the pump (Grundfos or Wilo) and the Modbus-address can be selected for each pump under **Configuration ▶ Communication ▶ Function port x ▶ Modbus Pumps ▶ Pump x**.

A digital output (**Configuration ▶ Inputs/Outputs ▶ Pumps DO**) can be configured to start the pump.

Informations read from the pump are shown under **Inputs/Outputs ▶ Pump x**:

- ✓ Start/Stop
- ✓ Alarm
- ✓ Flow (m³/h)
- ✓ Head (bar)
- ✓ Power (W)

M-Bus

M-Bus meters can be connected to a serial port on the controller (via the M-Bus-converter X1176) or to the built-in M-Bus-interface (only models with the letter “M” in the article number).

```
Function port1
M-Bus
```

```
Function port M-Bus
Active
```

```
Heat meter
Water meter
```

```
HS1
HS2
HS3
HS4
HW1
HW2
DHS1
```

```
Heat meter
Not Active
Address: 0
Interval:Always
```

```
Water meter 1
Water meter 2
```

Intervals

Different intervals are possible to set; Always, 15 min, 30 min, 1h and 24h.

External sensor

EcoGuard can be used instead of a physically connected (AI) room sensor. It uses the RS485 port to register values from the sensors connected to an EcoGuard unit.

It is possible to select which HS circuit(s) (one or several) that the EcoGuard should be connected to. Please note that it is not possible to use both EcoGuard and a physically connected (AI) sensor for the same HS circuit.

In order to connect EcoGuard to Exigo, it is first necessary to configure a RS485 port to **Expansion unit/ External sensor**.

EcoGuard makes use of the fixed PLA:ELA address 200:241, load number 10 and cell number 0 (pre-set in EcoGuard).

3.17.2 TCP/IP

The *Dynamic Host Configuration Protocol* (DHCP) is a network protocol used on *Internet Protocol* (IP) networks for dynamic distribution of network configuration parameters, such as IP addresses, DNS servers and other services. The controller can be configured to either obtain an IP address from a DHCP server (dynamic) or the address can be set manually (static).

Three additional functions can be activated on the network interface:

- ✓ BACnet IP communication
- ✓ Connection to the Cloud-server
- ✓ Modbus TCP

If you wish to set a static IP address for the controller, enter the IP address you wish to use along with the subnet mask, gateway address and DNS server address:

```
TCP/IP
```

```
DHCP: Yes
Set static IP
Current IP
-
```

```
IP
192.168.001.234
Subnet mask
255.255.255.000
```

```
Current subnet mask
-
Current gateway
-
```

```
Default gateway
192.168.001.001
DNS
192.168.001.001
```

```
Current DNS
-
```

BACnet / IP configuration

The BACnet/IP protocol is disabled as default. To enable BACnet/IP communication, change the setting from **Not active** to **Active**. The protocol will then be available for use:

```
TCP/IP
```

```
BACnet/IP
communication
Active
```

```
Device name
Exigo
BBMD address
```

```
Device ID low
2640
Device ID high
0 (x10000)
```

```
UDP port Number Low
7808
UDP port Number High
4 (x10000)
```

Device name

This is the device name that is shown on the BAS when a device is discovered.

BBMD address

The BBMD address (BACnet/IP Broadcast Management Device) is used for discovering devices that are attached to different BACnet/IP subnets and separated by an IP router. The address is entered as **host:port**, where **host** can be the host's name if DNS is configured. If DNS is not configured, the host address should be entered in the format **xxx.xxx.xxx.xxx**, followed by the port number (default setting 47808).

Example: mybbmd:47808 (with DNS configured) or 10.100.50.99:47808

Device ID

The ID of a device, used to identify it on the BACnet network. To set an ID value of 34600, the low number would be set to 4600 and the high number to 3.



Note! The ID number must be unique, and cannot be duplicated anywhere on the BACnet network.

CLOUDigo connection

To connect the controller to the Cloud server, this option must be activated.

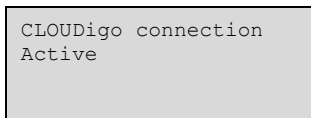
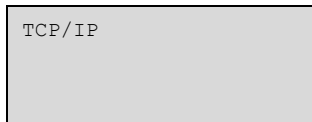

3.17.3 External display

The type of external display, connected to the display port can be set in this menu. Two options are available:

- ✓ E3-DSP – external text display
- ✓ ED-T7 – external touch display

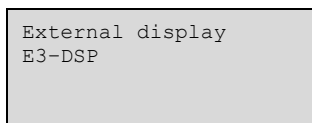

Note! When changing the display mode to ED-T7, the controller must be switched off and back on again for the change to take effect.

3.17.4 M-Bus ports

In units with an M-Bus port, that port can only be used to connect an M-Bus meter. A maximum of three meters can be connected.

3.17.5 Expansion units

A unit with at least one RS485 port is required in order for expansion units to be used.

3.17.6 External sensor

EcoGuard can be used instead of a physically connected (AI) room sensor. It uses the RS485 port to register values from the sensors connected to an EcoGuard unit.

It is possible to select which HS circuit(s) (one or several) that the EcoGuard should be connected to. Please note that it is not possible to use both EcoGuard and a physically connected (AI) sensor for the same HS circuit.

In order to connect EcoGuard to Exigo, it is first necessary to configure a RS485 port to **Expansion unit/ External sensor**.

EcoGuard makes use of the fixed PLA:ELA address 200:241, load number 10 and cell number 0 (pre-set in EcoGuard).

3.18 System

3.18.1 Changing language

Use this menu to change the display language.

```
Choose language
English
```



Note! This menu is also directly accessible by holding the [OK] button pressed during power-up or by pressing the [▶] button four times when the start display is shown.

3.18.2 Choose start screen

There are several different start screens to choose from.

Type 1

The second line shows the date and time.

The third line shows the text HS1.

The fourth line shows the current temperature setpoint and actual values for HS1.

```
Heating controller
04:09:15 11:28
HS1
Sp:32.8°C Act:33.1
```

Type 2

The second line shows the date and time.

The third line shows the text HW1.

The fourth line shows the current temperature setpoint and actual values for HW1.

```
Heating controller
04:09:15 11:28
HW1
Sp:55.0°C Act:54.8°C
```

Type 3

The second line shows the text HS1/HW1.

The third line shows the current setpoint and actual temperature for HS1.

The fourth line shows the current setpoint and actual temperature for HW1.

```
Heating controller
HS1/HW1
Sp:45.5°C Act:43.8°C
Sp:55.0°C Act:54.8°C
```

Type 4

The second line shows the current outdoor temperature.

The third line shows the text HS1.

The fourth line shows the current temperature setpoint and actual values for HS1.

```
Heating controller
Outd temp: 8.2°C
HS1
Sp:32.8°C Act:33.1°C
```

Type 5

The second line shows the text HS1/HS2.

The third line shows the current setpoint and actual temperature for HS1.

The fourth line shows the current setpoint and actual temperature for HS2.

```
Heating controller
HS1/HS2
Sp:34.0°C Act:34.2°C
Sp:42.0°C Act:41.5°C
```

Type 6

The second line shows the date and time.

```
Heating controller
04:09:15 11:28
```

Type 7

The second line shows the date and time.

The third line shows the actual value for the boiler.

```
Heating controller
04:09:15 11:28
Boiler Act:57.8°C
```

Type 8

The second line shows the date and time.

The third line shows the actual value for the boiler.

The fourth line shows the current outdoor temperature.

```
Heating controller
04:09:15 11:28
Boiler Act:57.8°C
Outd temp: 8.2°C
```

3.18.3 Automatic summer / winter time adjustment

The internal clock is normally configured for automatic summer/winter time adjustment. The function can be disabled in this menu. When enabled, the clock will be advanced one hour at 02:00 am the last Sunday of March and adjusted back one hour at 03:00 am the last Sunday of October.

```
Automatic
summer/winter time
change-over
On
```

3.18.4 Address

The controller uses the below addresses when connecting to Exigo tool and when multiple controllers are connected in a network. Exigo tool normally uses the addresses below, so if an address is changed, the new address must also be entered in Exigo tool. If several controllers are connected in a network, all the units must have the same PLA address, but each unit must have a unique ELA address.

```
Address:
PLA: 254
ELA: 254
```

3.18.5 Address for remote communication

If multiple controller units are connected in a network, it is possible to remote control a unit in the network from a unit with display. This is done by entering the address of the unit you wish to remote control in the unit with display. This function is aborted by pressing the buttons [▲], [OK] and [▼] simultaneously.

```
Address for remote
communication
(PLA:ELA) : 00:00
```

3.18.6 Automatic logoff

If the access level is set to **Operator** or **Admin**, the user will automatically be logged off after a set time of inactivity. The time is settable in units of 5 seconds. Default 60 units = 5 minutes.

The automatic logoff can be disabled, see *chapter 2 Information for the end user*.

```
Time before user
automatically is
logged off: 60
(unit 5 s)
```

3.19 Changing the battery

The controller has an internal battery to ensure the operation of the memory and real-time clock in the event of a power failure. When the alarm **Internal Battery** is activated and the battery LED lights up red (24 V

models), the battery has become too weak and needs to be changed. Nonetheless, due to a backup capacitor, the controller will function at least 10 minutes without power supply.



Caution! Changing the battery, as well as dismantling and opening the unit requires knowledge of proper ESD protection. Therefore, this should be handled by qualified personnel.

An earthed wristband must be used during this procedure.

3.19.1 24 V models (Exigo Ardo)

1. Remove the cover by pressing down the locking torques at the edge of the cover using a small screwdriver, and at the same time pulling the cover outwards.



2. Grip the battery firmly with your fingers and lift it upwards until it rises from its holder.

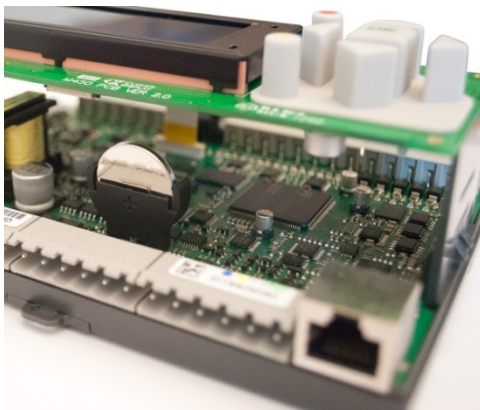

3. Press the new battery firmly down into place.



Note! For proper functionality, ensure that the polarity is correct. The replacement battery must be of type CR2032.

3.19.2 230 V models (Exigo Vido)

The 230 models should not be opened by the user. Please contact RegIn if you need to change the battery.

4 Information for the installer

4.1 Installation

The controller can be mounted in a DIN-standard casing (minimum 9 modules), on a DIN-rail in a cabinet or, using a suitable front-mounting kit, in a cabinet door or other control panel. The 230 V models can also be mounted directly on a wall.

4.1.1 Terminals

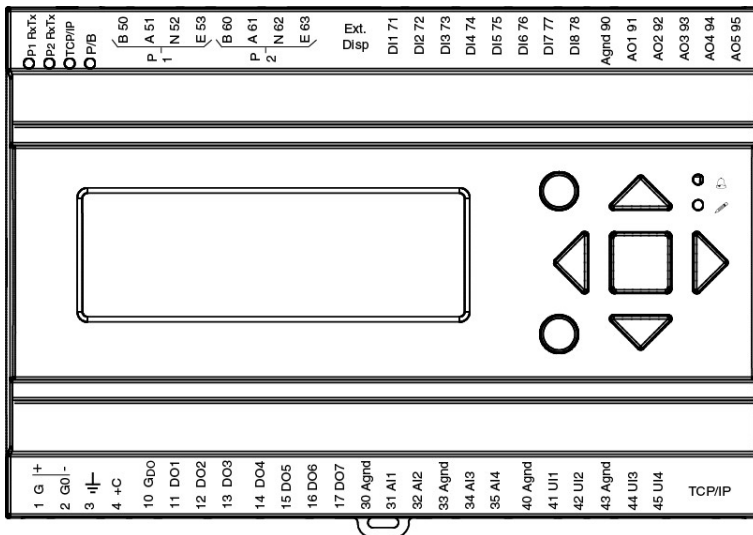

Figure 4-1 Terminal positions 24 V models

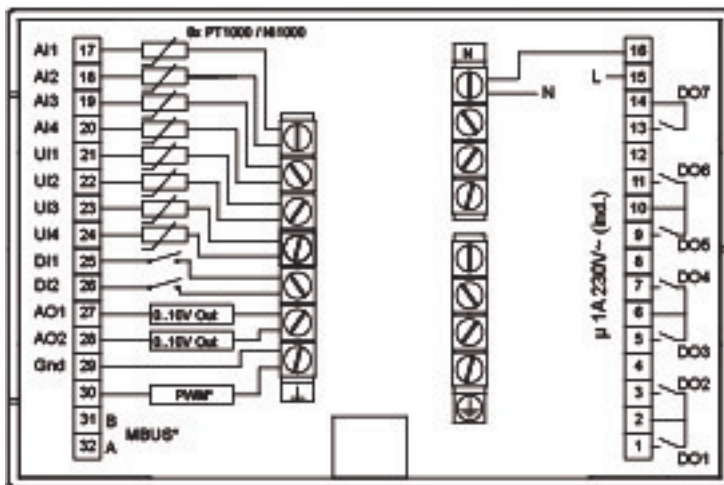

Figure 4-2 Terminal positions 230 V models

* depending on the model

4.1.2 Wiring



Caution! Before removing the controller from the terminal block, be sure to switch off the supply voltage.



Caution! It is important to ensure that the wiring is performed correctly and in accordance with the instructions given in this manual.

Wiring examples

Figure 4-3 Wiring example and Figure 4-4 Wiring example show wiring examples for Exigo Ardo

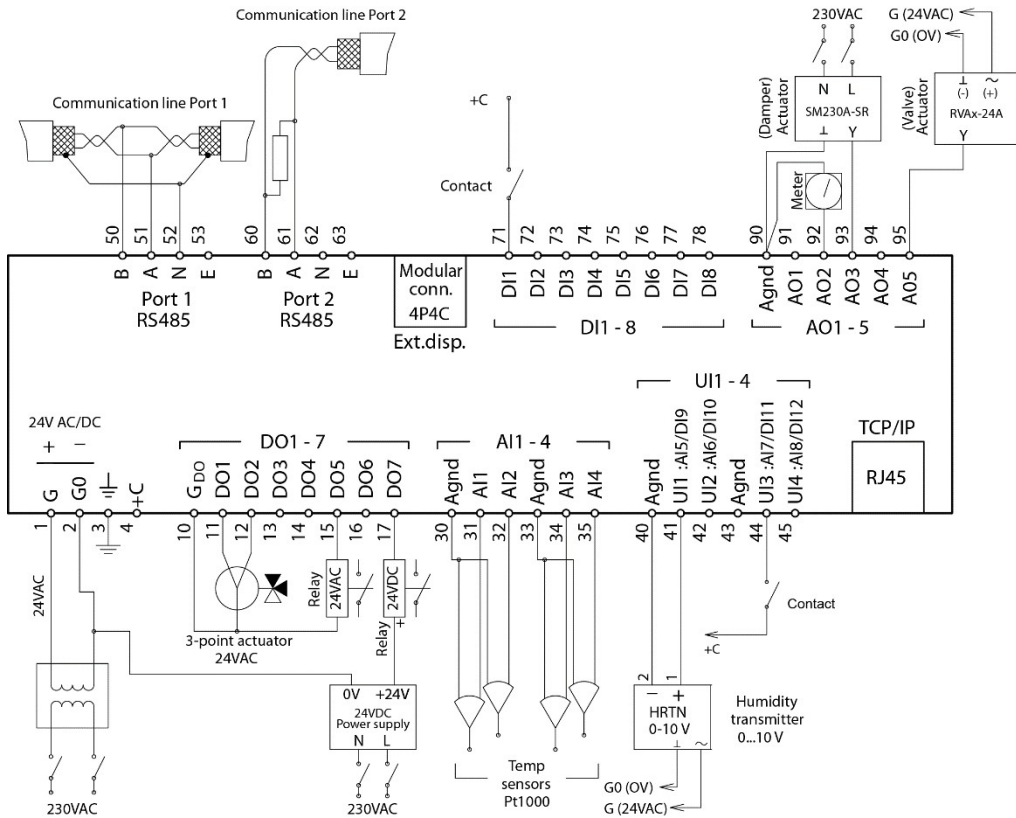

Figure 4-3 Wiring example

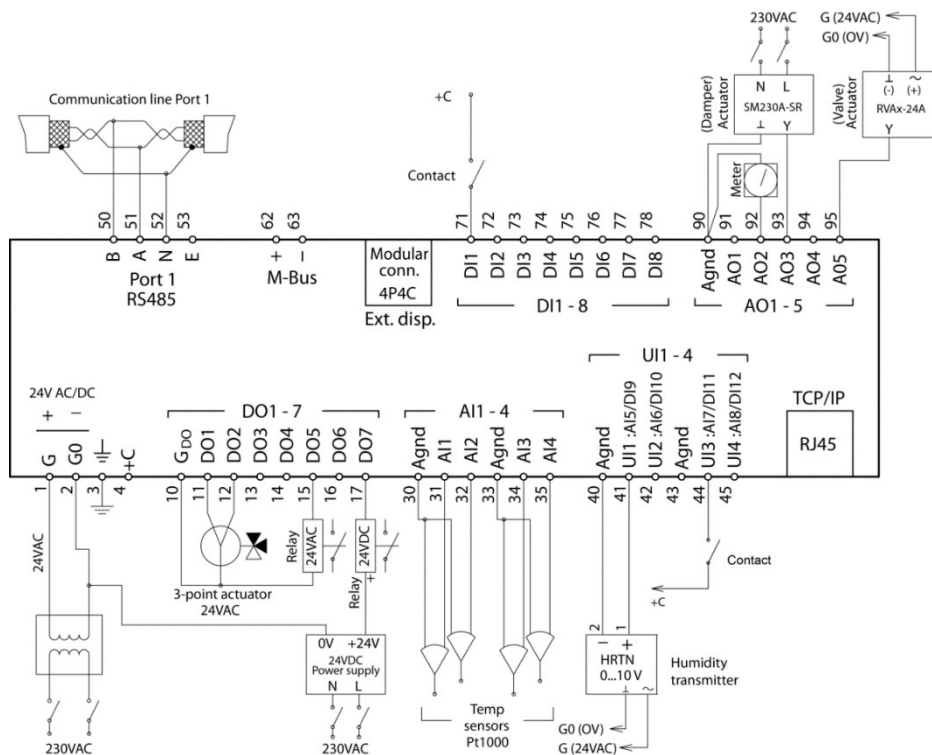

Figure 4-4 Wiring example

Inputs and outputs 24 V models (Exigo Ardo)

There is a list of input and outputs in *Appendix C Input and output lists* that can be a handy instrument to help you keep track of which inputs and outputs you need to configure.

Analogue inputs

Analogue inputs must refer to an Agnd terminal.

Analogue inputs can, depending on the configuration, be used for either PT1000/Ni1000 temperature sensors or for 0...10 V DC analogue input signals, for example from a pressure transmitter.

Digital inputs

Digital inputs must refer to +C on terminal 4. Digital inputs may only be wired to voltage-free contacts. Any external voltage applied to a digital input may harm the unit.

Universal inputs

A universal input can be configured to act as either an analogue input or as a digital input.

A universal input configured as an analogue input can, depending on the configuration, be used for either PT1000/Ni1000 temperature sensors or for 0...10 V DC analogue input signals, for example from a pressure transmitter.

Universal inputs configured as an analogue input must refer to an Agnd terminal.

A universal input configured as a digital input must, just like other digital inputs refer to C+ on terminal 4. It may only be wired to voltage-free contacts.

Analogue outputs

Analogue outputs must refer to a Agnd terminal.

All analogue outputs can be individually set to any one of the following output signals:

- ✓ 0...10 V DC
- ✓ 2...10 V DC
- ✓ 10...0 V DC
- ✓ 10...2 V DC



Caution! If the controller and its connected actuators share the same transformer, it is essential that the same transformer pole is used as reference for all the equipment. The equipment may otherwise not function as intended and may also suffer damages.

Digital outputs

Digital outputs should normally refer to G_{DO} on terminal 10. G_{DO} is internally connected to G on terminal 1 and supplies 24 V AC or DC depending on the choice of supply voltage.

All the digital outputs are controlled by MOSFET transistors. The outputs are internally connected with G_0 and can deliver max 2 A per output. However, the total power for all the DOs must not exceed 8 A.

A number of different wiring alternatives are possible depending on the type of supply voltage to the controller and the relay type.

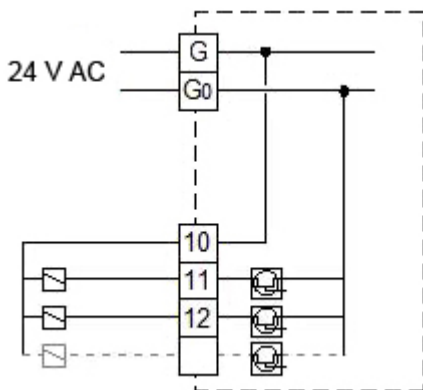

Figure 4-5 24 V AC supply and 24 V AC relays

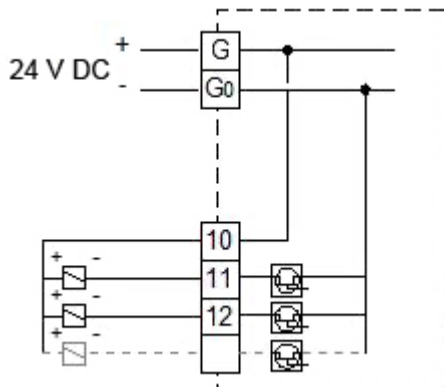

Figure 4-6 24 V DC supply and 24 V DC relays

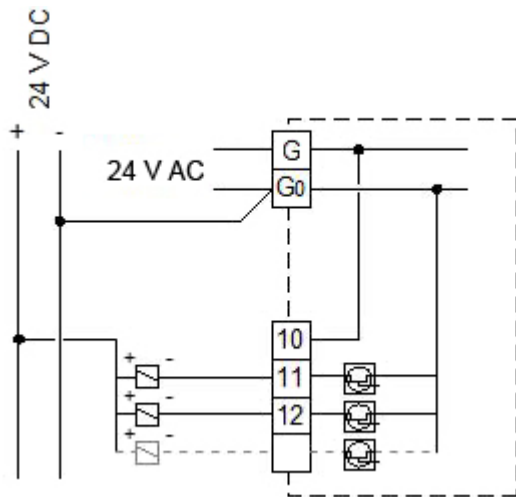

Figure 4-7 24 V AC supply and 24 V DC relays

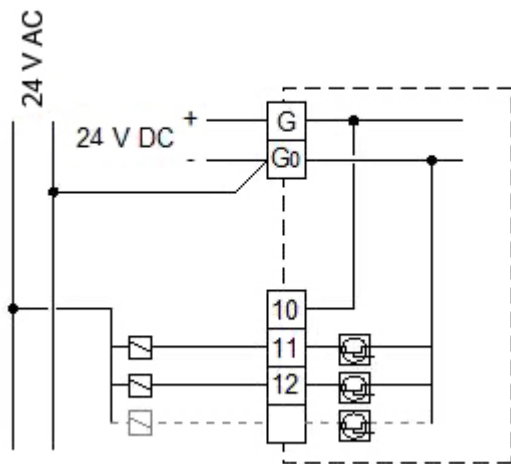

Figure 4-8 24 V DC supply and 24 V AC relays

Inputs and outputs 230 V models (Exigo Vido)

There is a list of input and outputs in *Appendix C Input and output lists* that can be a handy instrument to help you keep track of which inputs and outputs you need to configure.

Analogue inputs

Analogue inputs must refer to a \perp terminal.

Analogue inputs are intended for use with PT1000/Ni1000 sensors as a temperature sensor.

Digital inputs

Digital inputs must refer to a \perp terminal.

Universal inputs

A universal input can be configured to act as either an analogue input or as a digital input.

A universal input configured as an analogue input can be used with PT1000/Ni1000 temperature sensors.

A universal input configured as an analogue input must refer to a \perp terminal.

A universal input configured as a digital input must refer to a \perp terminal.

Universal analogue

Universal analogue I/O:s can be configured as either analogue inputs or analogue outputs.

Analogue outputs must refer to a \perp terminal. The outputs can be individually set to any one of the following output signals:

- ✓ 0...10 V DC
- ✓ 2...10 V DC
- ✓ 10...0 V DC
- ✓ 10...2 V DC

Digital outputs

The relays are voltage-free and must receive power from a single pole for each relay.

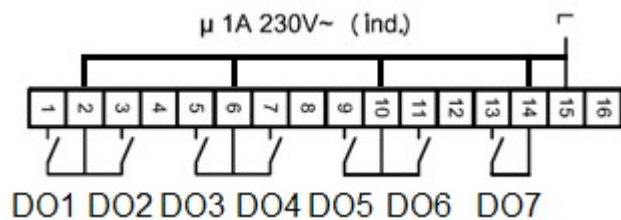

Figure 4-9 Digital outputs

M-Bus meters

This function requires a controller with an M-Bus port. Up to three meters can be connected (heat, energy or water).

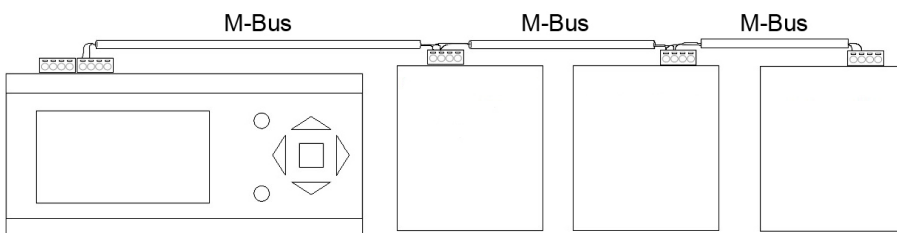

Figure 4-10 M-Bus meters

The following variables can be read from the meters:

- ✓ Supply temperature
- ✓ Return temperature
- ✓ Delta temperature
- ✓ Energy
- ✓ Effect
- ✓ Volume
- ✓ Flow

Expansion units EXOline

The communication between master and expansion units takes place via EXOline. The slave units will be assigned the address 241:1 and 241:2 during initialisation (PLA:ELA).

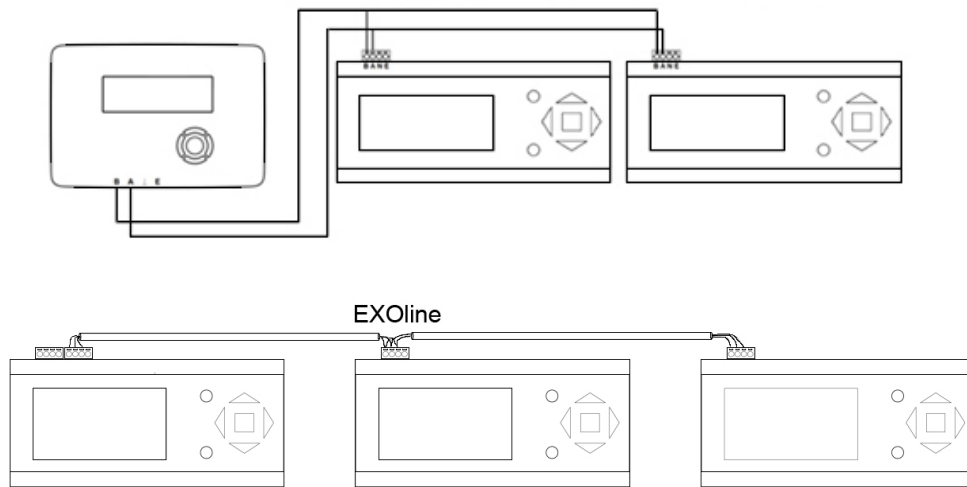

Figure 4-11 Expansion units EXOline

4.2 Commissioning

Before the controller can be used, inputs and outputs as well as a number of parameters must be configured.

All commissioning can be performed using the display and buttons on the controller, or by using an external display unit.

The easiest way however, is to configure the controller by using Exigo tool, that can be downloaded from <http://www.regincontrols.com>.

4.2.1 Configuration using Exigo tool

Exigo tool is a PC-based configuration program developed to simplify the commissioning of the Exigo controller series.

When using Exigo tool, the whole configuration and all settings can be done on the computer and then be uploaded to the controller. An infinite number of configurations can be stored in the computer memory for later use.

A communication cable is required in order to upload the configuration to the controller. The controller must also be powered up and the application selected in order for it to be configured.

Predefined configurations can be downloaded as htc-files from Regin's website, www.regincontrols.com. These htc-files can be opened in the tool and synchronized to the controller.

For more information, see the Exigo tool manual.

4.2.2 Configuration using the built-in display or an external display

1. Power up the controller.
2. On delivery, the heating application is activated. If you need to change the active application, see *Loading the application* below.

3. Log on as **Admin**.
4. Configure all required inputs and outputs. Keep track of which inputs and outputs you will need for the functions you choose to activate. There is a complete list of input and output functions in *Appendix C Input and output lists*.
5. Configure all needed functions. See *chapter 3 Information for the specialist*.
6. Set the time, date and configure the time schedule/holiday schedule in the **Time Settings** menu.
7. Set all the control setpoints for the configured functions.

Loading the application

Reset the controller by pressing the reset button, using for example a paper clip. The initial screen shows the factory application. It contains options for setting up the controller before start-up. Press the **[▶]** button to select **Application**:

```
Application
System
Communication
Time/Date
Inputs/Outputs
```

Use the **[▼]** and **[▲]** buttons to move the cursor in the left side of the display to the desired function. Select **Application** and press the **[▶]** button.

```
Heating 4.2
Expansion unit 1
Expansion unit 2
```

Move the cursor to the desired application and press the **[▼]** button.

```
Title:
Heating 4.2

Activate? Yes
```

Press the **[OK]** button and change **No** into **Yes**, then press **[OK]** again.

The most recently loaded application will now be entered into memory. This will take approx. 30 seconds.

To change language, press the **[▶]** button 3 times when the start screen for selecting an application is displayed.

Configuring the inputs and outputs

On delivery, there is no configured inputs and outputs.

Use the **[▼]** and **[▲]** buttons to move the cursor in the left side of the display to the desired function. Select **Configuration** and press the **[▶]** button.

```
Time Settings
Alarm Events
Inputs/Outputs
Configuration
```

Use the **[▼]** and **[▲]** buttons to move the cursor in the left side of the display to the desired function. Select **Inputs/Outputs** and press the **[▶]** button.

```
AI/UAI
DI/UDI
AO
DO
```

The next display shows the current values of the selected type of IO. The example shows the analogue inputs.

```
AI1 17.6 UAI1 12.1
AI2 23.1 UAI2 27.3
AI3 45.8 UAI3 -5.1
AI4
```

Press the **[▶]** button to show the configuration of AI's.

```
AI1 Raw: 17.6
Not Used
Compensation: 0.0°C
Sensor Type:PT1000
```

Press the **[OK]** button and change **Not Used** to the function you want to select.

Press the **[OK]** button again to choose the selected function and jump to the value of the compensation. Finish the configuration of the AI by selecting the type of sensor.

Appendix A Technical data

A.1 Exigo Ardo

A.1.1 General data

Supply voltage	24 V AC \pm 15%, 50...60 Hz or 21...36 V AC
Power consumption	See <i>Appendix B Model overview</i>
Ambient temperature	0...50 °C
Ambient humidity	Max. 95 % RH
Storage temperature	-20...70 °C
Protection class	IP20
Connection	Disconnectable terminal strips, 4 mm ²
Memory backup	Built-in long life battery gives long backup time of all settings incl. real time
Display	Backlit LCD, 4 rows of 20 characters
Mounting	DIN-rail or cabinet
Casing	Standard Euronorm (8.5 modules wide)
Dimensions (WxHxD)	149 x 121 x 60 mm incl. terminals
Battery type	CR2032 replaceable Lithium cell
Battery life	Min. 5 years
Operating system	EXOrealC

A.1.2 Communication ports

TCP/IP	EXOline, Modbus, BACnet/IP, CLOUDigo
RS485	EXOline, Modbus, BACnet MS/TP
M-Bus	M-Bus communication

A.1.3 Inputs & outputs

Analogue inputs (AI)	For PT1000 sensors (accuracy \pm 0.4 °C) or 0...10 V DC (accuracy \pm 0.15 % of full output signal). 12 bit resolution in the A/D conversion.
Digital inputs (DI)	For potential-free contacts.
Universal inputs (UI)	Can be set to act as either analogue input or digital input with specifications as above.
Analogue inputs/outputs (UAI)	0...10 V DC, 1 mA, short-circuit protected.
Digital outputs (DO)	Mosfet outputs, 24 V AC or DC, 2 A continuous. Max. 8 A in total.

A.2 Exigo Vido

A.2.1 General data

Supply voltage	85...265 V AC, 50/60 Hz
Power consumption	See <i>Appendix B Model overview</i>
Ambient temperature	0...50 °C
Ambient humidity	Max. 95 % RH
Storage temperature	-20...70 °C
Protection class	IP20, IP40 when mounted in cabinet
Memory backup	Built-in long life battery gives long backup time of all settings incl. real time
Display	Backlit LCD, 4 rows of 20 characters
Mounting	DIN-rail, cabinet or on wall
Dimensions (WxHxD)	146.7 x 97.6 x 76.0 mm incl. terminals
Battery type	CR2032 replaceable Lithium cell
Battery life	Min. 8 years
Operating system	EXOrealC

A.2.2 Communication ports

TCP/IP	EXOline, Modbus, BACnet/IP, CLOUDigo
RS485	EXOline, Modbus, BACnet MS/TP
M-Bus	M-Bus communication

A.2.3 Inputs & outputs

Analogue inputs (AI)	For PT1000 sensors. 12 bit resolution in the A/D conversion.
Digital inputs (DI)	For potential-free contacts.
Universal inputs (UI)	Can be set to act as either analogue input or digital input with specifications as above.
Analogue inputs/outputs (UAI)	Configurable as output (0...10 V DC, 2...10 V DC, 10...0 V DC or 10...2 V DC, 8 bit D/A short-circuit protected) or input (0...10 V DC).
Digital outputs (DO)	7x relay, 230 V AC, 1 A load per relay, max 7 A total.

Appendix B Model overview

Name	Supply voltage	Description
IO-A15MIXW-3-BEM IO-A28MIXW-3-BEM	24 V	Ardo Expansion unit with one RS485 port
HCA151DW-3 HCA281DW-3	24 V	Ardo Controller with one TCP/IP port
HCA152DW-3 HCA282DW-3	24 V	Ardo Controller with one RS485 port and one TCP/IP port
HCA283DW-3	24 V	Ardo Controller with two RS485 ports and one TCP/IP port
HCA283DWM-3	24 V	Ardo Controller with one RS485 port, one M-Bus port and one TCP/IP port
HCV190D-1	230 V	Vido Controller without communication ports
IO-V19MIXW-1-BEM	230 V	Vido Expansion unit with one RS485 port
HCV192DW-1	230 V	Vido Controller with one RS485 port and one TCP/IP port
HCV193DWM-1 HCV203DWM-1	230 V	Vido Controller with one RS485 port, one M-Bus port and one TCP/IP port
HCV191DW-1	230 V	Vido Controller with one TCP/IP port

Name	AI	DI	UI*	AO	DO	RS485 ports	TCP/IP ports	M-Bus ports	Display	Power consumption (VA)
IO-A15MiXW-3-BEM	4	4	-	3	4	1	1	-	-	5
HCA151DW-3	4	4	-	3	4	-	1	-	✓	9
HCA152DW-3	4	4	-	3	4	1	1	-	✓	9
IO-A28MIXW-3-BEM	4	8	4	5	7	1	1	-	-	5
HCA281DW-3	4	8	4	5	7	-	1	-	✓	9
HCA282DW-3	4	8	4	5	7	1	1	-	✓	9
HCA283DW-3	4	8	4	5	7	2	1	-	✓	9
HCA283DWM-3	4	8	4	5	7	1	1	1	✓	9
HCV190D-1	4	2	4	2**	7	-	-	-	✓	7.5
IO-V19MIXW-1-BEM	4	2	4	2**	7	1	1	-	-	7.5
HCV192DW-1	4	2	4	2**	7	1	1	-	✓	10
HCV193DWM-1	4	2	4	2**	7	1	1	1	✓	10.5
HCV203DWM-1	4	2	4	2**	7	1	1	1	✓	11
HCV191DW-1	4	2	4	2**	7	-	1	-	✓	9.5

* Universal inputs can be configured to function as either analogue or digital outputs.

** Universal analogue that can be configured to function as either analogue inputs or analogue outputs (0... 10 V DC).

Appendix C Input and output lists

The lists below are intended to be used as a memory aid during configuration, in order to help keep track of the desired input and output functions.

The left column contains a description of the in-/output signal, the middle column displays the name of the corresponding signal in Exigo tool and the right column shows the text displayed in the controller.

C.1 Analogue inputs

✓	Description	Name in Exigo tool	Name in display
	Inactive input	Not used	Not used
	Outdoor temperature sensor	Outdoor temp	Outdoor temp
	Outdoor temperature sensor, HS2	Outdoor temp HS2	Outdoor temp HS2
	Outdoor temperature sensor, HS3	Outdoor temp HS3	Outdoor temp HS3
	Outdoor temperature sensor, HS4	Outdoor temp HS4	Outdoor temp HS4
	Supply temperature, HS1	HS1, supply temp	HS1 supply temp
	Room temperature, HS1	HS1, room temp	HS1 room temp
	Return temperature, HS1	HS1, return temp	HS1 return temp
	Universal limitation temperature, HS1	HS1, univ limit temp	HS1 univ limit temp
	Universal limitation shift temperature, HS1	HS1, univ limit shift temp	HS1 UnivLimShiftTemp
	Relative humidity sensor, HS1	HS1, RH	HS1 RH
	Differential pressure, HS1	HS1, differential pressure	HS1 Diff Pressure
	Supply temperature, HS2	HS2, supply temp	HS2 supply temp
	Room temperature, HS2	HS2, room temp	HS2 room temp
	Return temperature, HS2	HS2, return temp	HS2 return temp
	Universal limitation temperature, HS2	HS2, univ limit temp	HS2 univ limit temp
	Universal limitation shift temperature, HS2	HS2, univ limit shift temp	HS2 UnivLimShiftTemp
	Relative humidity sensor, HS2	HS2, RH	HS2 RH
	Differential pressure, HS2	HS2, differential pressure	HS2 Diff Pressure
	Supply temperature, HS3	HS3, supply temp	HS3 supply temp
	Room temperature, HS3	HS3, room temp	HS3 room temp
	Return temperature, HS3	HS3, return temp	HS3 return temp
	Universal limitation temperature, HS3	HS3, univ limit temp	HS3 univ limit temp
	Universal limitation shift temperature, HS3	HS3, univ limit shift temp	HS3 UnivLimShiftTemp
	Relative humidity sensor, HS3	HS3, RH	HS3 RH
	Differential pressure, HS3	HS3, differential pressure	HS3 Diff Pressure
	Supply temperature, HS4	HS4, supply temp	HS4 supply temp
	Room temperature, HS4	HS4, room temp	HS4 room temp
	Return temperature, HS4	HS4, return temp	HS4 return temp
	Universal limitation temperature, HS4	HS4, univ limit temp	HS4 univ limit temp
	Universal limitation shift temperature, HS4	HS4, univ limit shift temp	HS4 UnivLimShiftTemp
	Relative humidity sensor, HS4	HS4, RH	HS4 RH
	Differential pressure, HS4	HS4, differential pressure	HS4 Diff Pressure
	Supply temperature HW1	HW1, supply temp	HW1 supply temp
	Tank temperature middle, HW1	HW1, tank middle temp	HW1 tank middle temp

✓	Description	Name in Exigo tool	Name in display
	Tank temperature bottom, HW1	HW1, tank bottom temp	HW1 tank bottom temp
	Solar tank temperature, HW1	HW1, solar tank temp	HW1 solar tank temp
	Limitation temperature, HW1	HW1, limit temp	HW1 limit temp
	Circulation return temperature, HW1	HW1, circ return temp	HW1 circ return temp
	External setpoint, HW1	HW1, external setpoint	HW1 external setp
	Supply temperature HW2	HW2, supply temp	HW2 supply temp
	Tank temperature middle, HW2	HW2, tank middle temp	HW2 tank middle temp
	Tank temperature bottom, HW2	HW2, tank bottom temp	HW2 tank bottom temp
	Solar tank temperature, HW2	HW2, solar tank temp	HW2 solar tank temp
	Limitation temperature, HW2	HW2, limit temp	HW2 limit temp
	Circulation return temperature, HW2	HW2, circ return temp	HW2 circ return temp
	External setpoint, HW2	HW2, external setpoint	HW2 external setp
	Boiler supply temperature	Boiler supply temp	Boiler supply temp
	Boiler return temperature	Boiler return temp	Boiler return temp
	Supply temperature for boiler 1	Boiler 1, supply temp	Boiler1 supply temp
	Return temperature for boiler 1	Boiler 1, return temp	Boiler1 return temp
	Supply temperature for boiler 2	Boiler 2, supply temp	Boiler2 supply temp
	Return temperature for boiler 2	Boiler 2, return temp	Boiler2 return temp
	Supply temperature for boiler 3	Boiler 3, supply temp	Boiler3 supply temp
	Return temperature for boiler 3	Boiler 3, return temp	Boiler3 return temp
	Supply temperature for boiler 4	Boiler 4, supply temp	Boiler4 supply temp
	Return temperature for boiler 4	Boiler 4, return temp	Boiler4 return temp
	Supply temperature DHS1	DHS1, supply temp	DHS1 supply temp
	Return temperature DHS1	DHS1, return temp	DHS1 return temp
	External demand DHS1	DHS1, external demand	DHS1 external demand
	Tank temperature top, HP1	HP1, tank temp top	HP1 tank temp top
	Tank temperature bottom, HP1	HP1, tank temp bottom	HP1 tank temp bottom
	External demand, HP1	HP1, external demand	HP1 external demand
	Additional heat source, HP1	HP1, additional heat source	HP1, Add Heat Source
	Solar collector temperature, Solar	Solar, collector temp	Solar collector temp
	Solar return temperature, Solar	Solar, return temp	Solar return temp
	Heating primary, supply temperature	HP supply temp	HP supply temp
	Heating primary, return temperature	HP return temp	HP return temp
	Cooling primary, supply temperature	CP supply temp	CP supply temp
	Cooling primary, return temperature	CP return temp	CP return temp
	Input for receiving current heat demand from another Exigo (0...10 V corresponds to 0...100 degrees)	Heat demand temp	Heat demand temp
	Wind-speed transmitter, 0...10 V DC	Wind speed	Wind speed
	Differential pressure transmitter, 0...10 V DC	Diff pressure	Diff Pressure
	System pressure	System pressure	System pressure
	Extra temperature sensor 1	Extra temp sensor 1	Extra temp sensor1
	Extra temperature sensor 2	Extra temp sensor 2	Extra temp sensor2
	Extra temperature sensor 3	Extra temp sensor 3	Extra temp sensor3

✓	Description	Name in Exigo tool	Name in display
	Extra temperature sensor 4	Extra temp sensor 4	Extra temp sensor4
	Extra temperature sensor 5	Extra temp sensor 5	Extra temp sensor5

C.2 Digital inputs

✓	Description	Name in Exigo tool	Name in display
	Inactive input	Not used	Not used
	HS1 main switch	HS1, main switch	HS1 main switch
	Activates HS1 comfort mode	HS1, Extended running	HS1 extended running
	HS1, Change-over to cool-mode	HS1, change-over	HS1 change-over
	HS1, release of cool-mode	HS1, start cool	HS1 start cool
	On/Off-function for the valve, 0 or 100%, HS1	HS1, thermostat	HS1 thermostat
	Run indication/alarm circulation pump, P1A-HS1	HS1, pump A indication	HS1 pump A ind
	Run indication/alarm circulation pump, P1B-HS1	HS1, pump B indication	HS1 pump B ind
	HS1, energy pulse	HS1, energy pulse	HS1 energy pulse
	HS1, high supply temperature	HS1, high supply temperature	HS1, high supply temperature
	HS1, condensation	HS1, condensation	HS1, condensation
	HS1, heating position	HS1, heating position	HS1, heating closed
	HS1, cooling position	HS1, cooling position	HS1, cooling closed
	HS2 main switch	HS2, main switch	HS2 main switch
	Activates HS2 comfort mode	HS2, Extended running	HS2 extended running
	HS2, Change-over to cool-mode	HS2, change-over	HS2 change-over
	HS2, release of cool-mode	HS2, start cool	HS2 start cool
	On/Off-function for the valve, 0 or 100%, HS2	HS2, thermostat	HS2 thermostat
	Run indication/alarm circulation pump, P1A-HS2	HS2, pump A indication	HS2 pump A ind
	Run indication/alarm circulation pump, P1B-HS2	HS2, pump B indication	HS2 pump B ind
	HS2, energy pulse	HS2, energy pulse	HS2 energy pulse
	HS2, high supply temperature	HS2, high supply temperature	HS2, high supply temperature
	HS2, condensation	HS2, condensation	HS2, condensation
	HS2, heating position	HS2, heating position	HS2, heating closed
	HS2, cooling position	HS2, cooling position	HS2, cooling closed
	HS3 main switch	HS3, main switch	HS3 main switch
	Activates HS3 comfort mode	HS3, Extended running	HS3 extended running
	HS3, Change-over to cool-mode	HS3, change-over	HS3, change-over
	HS3, release of cool-mode	HS3, start cool	HS3 start cool
	On/Off-function for the valve, 0 or 100%, HS3	HS3, thermostat	HS3 thermostat
	Run indication/alarm circulation pump, P1A-HS3	HS3, pump A indication	HS3 pump A ind
	Run indication/alarm circulation pump, P1B-HS3	HS3, pump B indication	HS3 pump B ind
	HS3, energy pulse	HS3, energy pulse	HS3 energy pulse
	HS3, high supply temperature	HS3, high supply temperature	HS3, high supply temperature
	HS3, condensation	HS3, condensation	HS3, condensation
	HS3, heating position	HS3, heating position	HS3, heating closed
	HS3, cooling position	HS3, cooling position	HS3, cooling closed
	HS4 main switch	HS4, main switch	HS4 main switch

✓	Description	Name in Exigo tool	Name in display
	Activates HS4 comfort mode	HS4, Extended running	HS4 extended running
	HS4, Change-over to cool-mode	HS4, change-over	HS4, change-over
	HS4, release of cool-mode	HS4, start cool	HS4 start cool
	On/Off-function for the valve, 0 or 100%, HS4	HS4, thermostat	HS4 thermostat
	Run indication/alarm circulation pump, P1A-HS4	HS4, pump A indication	HS4 pump A ind
	Run indication/alarm circulation pump, P1B-HS4	HS4, pump B indication	HS4 pump B ind
	HS4, energy pulse	HS4, energy pulse	HS4 energy pulse
	HS4, high supply temperature	HS4, high supply temperature	HS4, high supply temperature
	HS4, condensation	HS4, condensation	HS4, condensation
	HS4, heating position	HS4, heating position	HS4, heating closed
	HS4, cooling position	HS4, cooling position	HS4, cooling closed
	HW1 main switch	HW1, main switch	HW1 main switch
	HW1 flow switch for electric heater	HW1, flow switch	HW1 flow switch
	Run indication/alarm tank pump A, HW1	HW1, tankpump A indication	HW1 tankpump A ind
	Run indication/alarm tank pump B, HW1	HW1, tankpump B indication	HW1 tankpump B ind
	Run indication/alarm exchanger pump A, HW1	HW1, exchangerpump A indication	HW1 exchpump A ind
	Run indication/alarm exchanger pump B, HW1	HW1, exchangerpump B indication	HW1 exchpump B ind
	Run indication/alarm circulation pump A, HW1	HW1, circulationpump A indication	HW1 circpump A ind
	Run indication/alarm circulation pump B, HW1	HW1, circulationpump B indication	HW1 circpump B ind
	HW1, energy pulse	HW1, energy pulse	HW1 energy pulse
	HW1, manual start of thermal disinfection	HW1, start thermal disinfection	HW1 start therm dis
	HW2 main switch	HW2, main switch	HW2 main switch
	HW2 flow switch for electric heater	HW2, flow switch	HW2 flow switch
	Run indication/alarm tank pump A, HW2	HW2, tankpump A indication	HW2 tankpump A ind
	Run indication/alarm tank pump B, HW2	HW2, tankpump B indication	HW2 tankpump B ind
	Run indication/alarm exchanger pump A, HW2	HW2, exchangerpump A indication	HW2 exchangerpump A ind
	Run indication/alarm exchanger pump B, HW2	HW2, exchangerpump B indication	HW2 exchangerpump B ind
	Run indication/alarm circulation pump A, HW2	HW2, circulationpump A indication	HW2 circulationpump A ind
	Run indication/alarm circulation pump B, HW2	HW2, circulationpump B indication	HW2 circulationpump B ind
	HW2, energy pulse	HW2, energy pulse	HW2 energy pulse
	HW2, manual start of thermal disinfection	HW2, start thermal disinfection	HW2 start therm dis
	Run indication/alarm for boiler 1	Boiler 1 indication	Boiler 1 indication
	Run indication/alarm for pump A/boiler 1	Boiler 1 pump A indication	Boiler1 pump A ind
	Run indication/alarm for pump B/boiler 1	Boiler 1 pump B indication	Boiler1 pump B ind
	Run indication/alarm for return pump/boiler 1	Boiler 1 return pump indication	Boiler 1 retpump ind
	Run indication/alarm for boiler 2	Boiler 2 indication	Boiler 2 indication
	Run indication/alarm for pump A/boiler 2	Boiler 2 pump A indication	Boiler2 pump A ind
	Run indication/alarm for pump B/boiler 2	Boiler 2 pump B indication	Boiler2 pump B ind
	Run indication/alarm for return pump/boiler 2	Boiler 2 return pump indication	Boiler 2 retpump ind
	Run indication/alarm for boiler 3	Boiler 3 indication	Boiler 3 indication
	Run indication/alarm for pump A/boiler 3	Boiler 3 pump A indication	Boiler3 pump A ind
	Run indication/alarm for pump B/boiler 3	Boiler 3 pump B indication	Boiler3 pump B ind
	Run indication/alarm for return pump/boiler 3	Boiler 3 return pump indication	Boiler 3 retpump ind
	Run indication/alarm for boiler 4	Boiler 4 indication	Boiler 4 indication
	Run indication/alarm for pump A/boiler 4	Boiler 4 pump A indication	Boiler4 pump A ind

Input and output lists

✓	Description	Name in Exigo tool	Name in display
	Run indication/alarm for pump B/boiler 4	Boiler 4 pump B indication	Boiler4 pump B ind
	Run indication/alarm for return pump/boiler 4	Boiler 4 return pump indication	Boiler 4 retpump ind
	Run indication/alarm for the transport pump A	Transport pump A indication	Transport pump A ind
	Run indication/alarm for the transport pump B	Transport pump B indication	Transport pump B ind
	Boiler alarm	Boiler alarm	Boiler alarm
	Pressure switch, expansion vessel	Expansion vessel	Expansion vessel
	Boiler control external stop	External stop boiler 1-4	Ext Stop Boiler 1-4
	Pressure/flow alarm for the boiler circuit	Pressure/flow error	System low pressure
	DHS1 main switch	DHS1, main switch	DHS1 main switch
	Run indication/alarm circulation pump A, DHS1	DHS1, pump A indication	DHS1 pump A ind
	Run indication/alarm circulation pump B, DHS1	DHS1, pump B indication	DHS1 pump B ind
	DHS1, energy pulse	DHS1, energy pulse	DHS1 energy pulse
	HP1 main switch	HP1, main switch	HP1 main switch
	Run indication/alarm load pump A, HP1	HP1, load pump A indication	HP1 load pump A ind
	Run indication/alarm load pump B, HP1	HP1, load pump B indication	HP1 load pump B ind
	Run indication/alarm add. heat source pump A, HP1	HP1 add. heat source pump A indication	HP1 AHS Pump A ind
	Run indication/alarm add. heat source pump B, HP1	HP1 add. heat source pump B indication	HP1 AHS Pump B ind
	Solar main switch	Solar, main switch	Solar main switch
	Run indication/alarm solar pump A	Solar, pump A indication	Solar pump A ind
	Run indication/alarm solar pump B	Solar, pump B indication	Solar pump B ind
	Start/Stop HS	Unit shutdown	Unit shutdown
	Acknowledge all alarms	Alarm acknowledgement	Alarm acknow
	Volume pulses, hot water usage	Water pulse	Water pulse
	Energy pulses, heating usage	Energy pulse	Energy pulse
	Volume pulse, cold water usage 1	CW1 pulse	CW1 pulse
	Volume pulse, cold water usage 2	CW2 pulse	CW2 pulse
	Energy pulse, electricity meter	Electric pulse	Electric pulse
	Run indication/alarm, frequency converters for pressure control	Frequency converter	Frequency converter
	Extra alarm 1	Extra alarm 1	Extra alarm 1
	Extra alarm 2	Extra alarm 2	Extra alarm 2
	Extra alarm 3	Extra alarm 3	Extra alarm 3
	Extra alarm 4	Extra alarm 4	Extra alarm 4
	Extra alarm 5	Extra alarm 5	Extra alarm 5
	Extra alarm 6	Extra alarm 6	Extra alarm 6
	Extra alarm 7	Extra alarm 7	Extra alarm 7
	Extra alarm 8	Extra alarm 8	Extra alarm 8
	Extra alarm 9	Extra alarm 9	Extra alarm 9
	Extra alarm 10	Extra alarm 10	Extra alarm 10

C.3 Universal inputs

Universal inputs on the controller can be individually configured as either analogue inputs, using any of the analogue inputs in *C.1 Analogue inputs*, or as digital inputs, using any of the digital inputs in *C.2 Digital inputs*.

C.4 Analogue outputs

✓	Description	Name in Exigo tool	Name in display
	Inactive output	Not used	Not used
	Valve actuator, heating system 1, HS1	HS1, actuator	HS1 actuator
	Continuous pump, heating system 1, HS1	HS1, pump continuous	HS1, pump continuous
	Valve actuator, heating system 2, HS2	HS2, actuator	HS2 actuator
	Continuous pump, heating system 2, HS2	HS2, pump continuous	HS2, pump continuous
	Valve actuator, heating system 3, HS3	HS3, actuator	HS3 actuator
	Continuous pump, heating system 3, HS3	HS3, pump continuous	HS3, pump continuous
	Valve actuator, heating system 4, HS4	HS4, actuator	HS4 actuator
	Continuous pump, heating system 4, HS4	HS4, pump continuous	HS4, pump continuous
	Valve actuator, hot water circuit 1, HW1	HW1, actuator	HW1 actuator
	Valve actuator, hot water circuit 2, HW2	HW2, actuator	HW2 actuator
	Burner, boiler 1	Boiler 1, modulating burner	HB1 mod burner
	Burner, boiler 2	Boiler 2, modulating burner	HB2 mod burner
	Burner, boiler 3	Boiler 3, modulating burner	HB3 mod burner
	Burner, boiler 4	Boiler 4, modulating burner	HB4 mod burner
	Valve actuator, return valve boiler 1	Boiler 1, return temp actuator	HB1 ret temp act
	Valve actuator, return valve boiler 2	Boiler 2, return temp actuator	HB2 ret temp act
	Valve actuator, return valve boiler 3	Boiler 3, return temp actuator	HB3 ret temp act
	Valve actuator, return valve boiler 4	Boiler 4, return temp actuator	HB4 ret temp act
	Valve actuator, district heating circuit 1, DHS1	DHS1, actuator	DHS1 actuator
	Solar actuator	Solar pump/valve control	Solar Pump/Valv Ctrl
	Highest setpoint for the configured circuits (0...100 degrees corresponds to 0...10 V)	Heat demand temp	Heat Demand Temp
	Frequency converter, pressure control	Diff pressure, valve	Diff Pressure Valve
	Sequential control of actuator	Seq control of actuator HS1-DHS1	Seq ctrl HS1-DHS1
	Outdoor temperature	Outdoor temperature	Outdoor temperature

C.5 Digital outputs

✓	Description	Name in Exigo tool	Name in display
	Inactive output	Not used	Not used
	Start/stop pump, P1A-HS1	HS1, pump A start	HS1 pump A start
	Start/stop pump, P1B-HS1	HS1, pump B start	HS1 pump B start
	3-position actuator HS1, increase	HS1, actuator increase	HS1 actuator increas
	3-position actuator HS1, decrease	HS1, actuator decrease	HS1 actuator decreas
	Start/stop dehumidifier, HS1	HS1, dehumidification	HS1 dehumidification

Input and output lists

✓	Description	Name in Exigo tool	Name in display
	Bypass valve for district cooling system, HS1	HS1, bypass CV1	HS1 bypass CV1
	Heating, HS1	HS1, heating	HS1, heating start
	Cooling, HS1	HS1, cooling	HS1, cooling start
	Start/stop pump, P1A-HS2	HS2, pump A start	HS2 pump A start
	Start/stop pump, P1B-HS2	HS2, pump B start	HS2 pump B start
	3-position actuator HS2, increase	HS2, actuator increase	HS2 actuator increas
	3-position actuator HS2, decrease	HS2, actuator decrease	HS2 actuator decreas
	Start/stop dehumidifier, HS2	HS2, dehumidification	HS2 dehumidification
	Bypass valve for district cooling system, HS2	HS2, bypass CV1	HS2 bypass CV1
	Heating, HS2	HS2, heating	HS2, heating start
	Cooling, HS2	HS2, cooling	HS2, cooling start
	Start/stop pump, P1A-HS3	HS3, pump A start	HS3 pump A start
	Start/stop pump, P1B-HS3	HS3, pump B start	HS3 pump B start
	3-position actuator HS3, increase	HS3, actuator increase	HS3 actuator increas
	3-position actuator HS3, decrease	HS3, actuator decrease	HS3 actuator decreas
	Start/stop dehumidifier, HS3	HS3, dehumidification	HS3 dehumidification
	Bypass valve for district cooling system, HS3	HS3, bypass CV1	HS3 bypass CV1
	Heating, HS3	HS3, heating	HS3, heating start
	Cooling, HS3	HS3, cooling	HS3, cooling start
	Start/stop pump, P1A, HS4	HS4, pump A start	HS4 pump A start
	Start/stop pump, P1B, HS4	HS4, pump B start	HS4 pump B start
	3-position actuator HS4, increase	HS4, actuator increase	HS4 actuator increas
	3-position actuator HS4, decrease	HS4, actuator decrease	HS4 actuator decreas
	Start/stop dehumidifier, HS4	HS4, dehumidification	HS4 dehumidification
	Bypass valve for district cooling system, HS4	HS4, bypass CV1	HS4 bypass CV1
	Heating, HS4	HS4, heating	HS4, heating start
	Cooling, HS4	HS4, cooling	HS4, cooling start
	Start/stop tank pump A, HW1	HW1, tankpump A start	HW1 tankpump A start
	Start/stop tank pump B, HW1	HW1, tankpump B start	HW1 tankpump B start
	Start/stop exchanger pump A, HW1	HW1, exchangerpump A start	HW1 exchpump A start
	Start/stop exchanger pump B, HW1	HW1, exchangerpump B start	HW1 exchpump B start
	Start/stop circulation pump A, HW1	HW1, circulationpump A start	HW1 circpump A start
	Start/stop circulation pump B, HW1	HW1, circulationpump B start	HW1 circpump B start
	3-position actuator HW1, increase	HW1, actuator increase	HW1 actuator increas
	3-position actuator HW1, decrease	HW1, actuator decrease	HW1 actuator decreas
	Start/stop thermal disinfection HW1	HW1, Thermal disinfection, heating	HW1 Thermal DisInf
	Start/stop thermal disinfection/cleaning HW1	HW1, Thermal disinfection / cleaning	HW1 Thermal Dis/Clean
	Start/stop tank pump A, HW2	HW2, tankpump A start	HW2 tankpump A start
	Start/stop tank pump B, HW2	HW2, tankpump B start	HW2 tankpump B start
	Start/stop exchanger pump A, HW2	HW2, exchangerpump A start	HW2 exchpump A start
	Start/stop exchanger pump B, HW2	HW2, exchangerpump B start	HW2 exchpump B start
	Start/stop circulation pump A, HW2	HW2, circulationpump A start	HW2 circpump A start
	Start/stop circulation pump B, HW2	HW2, circulationpump B start	HW2 circpump B start
	3-position actuator HW2, increase	HW2, actuator increase	HW2 actuator increas

✓	Description	Name in Exigo tool	Name in display
	3-position actuator HW2, decrease	HW2, actuator decrease	HW2 actuator decreas
	Start/stop thermal disinfection HW2	HW2, Thermal disinfection, heating	HW2 Thermal DisInf
	Start/stop thermal disinfection/cleaning HW2	HW2, Thermal disinfection / cleaning	HW2 Thermal Dis/Clean
	Start/stop burner 1	Boiler 1, burner	HB1 burner
	Start/stop burner 1, high effect	Boiler 1, burner (high effect)	HB1 burner (high)
	Start/stop pump A, boiler 1	Boiler 1, pump A start	HB1 pump A start
	Start/stop pump B, boiler 1	Boiler 1, pump B start	HB1 pump B start
	Start/stop return pump, boiler 1	Boiler 1, return pump start	HB1 ret pump start
	Start/stop burner 2	Boiler 2, burner	HB2 burner
	Start/stop burner 2, high effect	Boiler 2, burner (high effect)	HB2 burner (high)
	Start/stop pump A, boiler 2	Boiler 2, pump A start	HB2 pump A start
	Start/stop pump B, boiler 2	Boiler 2, pump B start	HB2 pump B start
	Start/stop return pump, boiler 2	Boiler 2, return pump start	HB2 ret pump start
	Start/stop burner 3	Boiler 3, burner	HB3 burner
	Start/stop burner 3, high effect	Boiler 3, burner (high effect)	HB3 burner (high)
	Start/stop pump A, boiler 3	Boiler 3, pump A start	HB3 pump A start
	Start/stop pump B, boiler 3	Boiler 3, pump B start	HB3 pump B start
	Start/stop return pump, boiler 3	Boiler 3, return pump start	HB3 ret pump start
	Start/stop burner 4	Boiler 4, burner	HB4 burner
	Start/stop burner 4, high effect	Boiler 4, burner (high effect)	HB4 burner (high)
	Start/stop pump A, boiler 4	Boiler 4, pump A start	HB4 pump A start
	Start/stop pump B, boiler 4	Boiler 4, pump B start	HB4 pump B start
	Start/stop return pump, boiler 4	Boiler 4, return pump start	HB4 ret pump start
	Start/stop transport pump A	Transport pump A start	Transp pump A start
	Start/stop transport pump B	Transport pump B start	Transp pump B start
	Start/stop pump A-DHS1	DHS1, pump A start	DHS1 pump A start
	Start/stop pump B-DHS1	DHS1, pump B start	DHS1 pump B start
	3-position actuator DHS1, increase	DHS1, actuator increase	DHS1 actuator increa
	3-position actuator DHS1, decrease	DHS1, actuator decrease	DHS1 actuator decrea
	Start/stop load pump A for storage tank, P1-HP1	HP1, load pump A start	HP1 pump A start
	Start/stop load pump B for storage tank, P1-HP1	HP1, load pump B start	HP1 pump B start
	Additional heat source pump A start	HP1, add. heat source pump A start	HP1, AHS pump A start
	Additional heat source pump B start	HP1, add. heat source pump B start	HP1, AHS pump B start
	Start/stop pump A, solar	Solar, pump A start	Solar pump A start
	Start/stop pump B, solar	Solar, pump B start	Solar pump B start
	Connect the solar system to HW or buffer	Solar, HW->buffer	Solar HW->buffer
	Solar, Cool down	Solar, Cool down	Solar, Cool down
	Sequential control of actuator HS1-DHS1 increase	Seq control of actuator HS1-DHS1 increase	SeqCtrl HS1-DHS1 inc
	Sequential control of actuator HS1-DHS1 decrease	Seq control of actuator HS1-DHS1 decrease	SeqCtrl HS1-DHS1 dec
	Cooling unit start	Cool unit start	Cool unit start
	Start/stop frequency converter, pressure control	Frequency converter start	Freq converter start
	Refill	Refill	Refill
	Sum alarm A + B + C	Sum alarm	Sum alarm
	Sum alarm A	Sum alarm A	Sum alarm A

Input and output lists

✓	Description	Name in Exigo tool	Name in display
	Sum alarm B + C	Sum alarm B/C	Sum alarm B/C
	Extra time channel 1	Time channel 1	Time channel 1
	Extra time channel 2	Time channel 2	Time channel 2
	Extra time channel 3	Time channel 3	Time channel 3
	Extra time channel 4	Time channel 4	Time channel 4
	Extra time channel 5	Time channel 5	Time channel 5

Appendix D Alarm list

The alarm text, priority and delay columns show the factory set values.

D.1 Heating system 1

No	Alarm text	Prio	Delay	Description
1	Malfunction P1A B-HS1	B	0 s	Malfunction pump P1A or P1B HS1
2	Deviation Supply HS1	A	60 min	Supply temperature HS1 deviates too much from the setpoint for too long
3	Deviation Room HS1	A	60 min	Room temperature HS1 deviates too much from the setpoint for too long
4	Malfunction P1A&B-HS1	A	0 s	Malfunction in both circulation pumps, P1A and P1B, in HS1
5	HS1 manual	C	0 s	HS1 in manual running mode
6	HS1 frost	A	0 s	HS1 frost protection active
7	HS1 high supply temperature	A	0 s	HS1 high temperature at supply
8	HS1 condensation	A	0 s	HS1 detection of condensation
9	Sensor error HS1 supply	B	5 s	Power failure or short-circuit sensor HS1 supply
10	Sensor error HS1 room	B	5 s	Power failure or short-circuit sensor HS1 room
11	Sensor error HS1 return	B	5 s	Power failure or short-circuit sensor HS1 return
12	Sensor error HS1 Universal Limit	B	5 s	Power failure or short-circuit sensor HS1 universal limit
13	Sensor error HS1 Universal Shift	B	5 s	Power failure or short-circuit sensor HS1 universal shift
14	Sensor error HS1 Humidity	B	5 s	Power failure or short-circuit sensor HS1 humidity
15	Sensor error HS1 differential pressure	B	5 s	Power failure or short-circuit sensor HS1 differential pressure
16	HS1 Screed Drying	A	5 h	HS1 malfunction screed drying

D.2 Heating system 2

No	Alarm text	Prio	Delay	Description
17	Malfunction P1A B-HS2	B	0 s	Malfunction pump P1A or P1B HS2
18	Deviation Supply HS2	A	60 min	Supply temperature HS2 deviates too much from the setpoint for too long
19	Deviation Room HS2	A	60 min	Room temperature HS2 deviates too much from the setpoint for too long
20	Malfunction P1A&B-HS2	A	0 s	Malfunction in both circulation pumps, P1A and P1B, in HS2
21	HS2 manual	C	0 s	HS2 in manual running mode
22	HS2 frost	A	0 s	HS2 frost protection active
23	HS2 high supply temperature	A	0 s	HS2 high temperature at supply
24	HS2 condensation	A	0 s	HS2 detection of condensation
25	Sensor error HS2 supply	B	5 s	Power failure or short-circuit sensor HS2 supply
26	Sensor error HS2 room	B	5 s	Power failure or short-circuit sensor HS2 room
27	Sensor error HS2 return	B	5 s	Power failure or short-circuit sensor HS2 return
28	Sensor error HS2 Universal Limit	B	5 s	Power failure or short-circuit sensor HS2 universal limit

No	Alarm text	Prio	Delay	Description
29	Sensor error HS2 Universal Shift	B	5 s	Power failure or short-circuit sensor HS2 universal shift
30	Sensor error HS2 Humidity	B	5 s	Power failure or short-circuit sensor HS2 humidity
31	Sensor error HS2 differential pressure	B	5 s	Power failure or short-circuit sensor HS2 differential pressure
32	HS2 Screed Drying	A	5 h	HS2 malfunction screed drying

D.3 Heating system 3

No	Alarm text	Prio	Delay	Description
33	Malfunction P1A B-HS3	B	0 s	Malfunction pump P1A or P1B HS3
34	Deviation Supply HS3	A	60 min	Supply temperature HS3 deviates too much from the setpoint for too long
35	Deviation Room HS3	A	60 min	Room temperature HS3 deviates too much from the setpoint for too long
36	Malfunction P1A&B-HS3	A	0 s	Malfunction in both circulation pumps, P1A and P1B, in HS3
37	HS3 manual	C	0 s	HS3 in manual running mode
38	HS3 frost	A	0 s	HS3 frost protection active
39	HS3 high supply temperature	A	0 s	HS3 high temperature at supply
40	HS3 condensation	A	0 s	HS3 detection of condensation
41	Sensor error HS3 supply	B	5 s	Power failure or short-circuit sensor HS3 supply
42	Sensor error HS3 room	B	5 s	Power failure or short-circuit sensor HS3 room
43	Sensor error HS3 return	B	5 s	Power failure or short-circuit sensor HS3 return
44	Sensor error HS3 Universal Limit	B	5 s	Power failure or short-circuit sensor HS3 universal limit
45	Sensor error HS3 Universal Shift	B	5 s	Power failure or short-circuit sensor HS3 universal shift
46	Sensor error HS3 Humidity	B	5 s	Power failure or short-circuit sensor HS3 humidity
47	Sensor error HS3 differential pressure	B	5 s	Power failure or short-circuit sensor HS3 differential pressure
48	HS3 Screed Drying	A	5 h	HS3 malfunction screed drying

D.4 Heating system 4

No	Alarm text	Prio	Delay	Description
49	Malfunction P1A B-HS4	B	0 s	Malfunction pump P1A or P1B HS4
50	Deviation Supply HS4	A	60 min	Supply temperature HS4 deviates too much from the setpoint for too long
51	Deviation Room HS4	A	60 min	Room temperature HS4 deviates too much from the setpoint for too long
52	Malfunction P1A&B-HS4	A	0 s	Malfunction in both circulation pumps, P1A and P1B, in HS4
53	HS4 manual	C	0 s	HS4 in manual running mode
54	HS4 frost	A	0 s	HS4 frost protection active
55	HS4 high supply temperature	A	0 s	HS4 high temperature at supply
56	HS4 condensation	A	0 s	HS4 detection of condensation
57	Sensor error HS4 supply	B	5 s	Power failure or short-circuit sensor HS4 supply

No	Alarm text	Prio	Delay	Description
58	Sensor error HS4 room	B	5 s	Power failure or short-circuit sensor HS4 room
59	Sensor error HS4 return	B	5 s	Power failure or short-circuit sensor HS4 return
60	Sensor error HS4 Universal Limit	B	5 s	Power failure or short-circuit sensor HS4 universal limit
61	Sensor error HS4 Universal Shift	B	5 s	Power failure or short-circuit sensor HS4 universal shift
62	Sensor error HS4 Humidity	B	5 s	Power failure or short-circuit sensor HS4 humidity
63	Sensor error HS4 differential pressure	B	5 s	Power failure or short-circuit sensor HS4 differential pressure
64	HS4 Screed Drying	A	5 h	HS4 malfunction screed drying

D.5 Hot water 1

No	Alarm text	Prio	Delay	Description
65	Malfunction Tank-P1A B-HW1	B	0 s	Malfunction Tank pump P1A or P1B HW1
66	Malfunction Exchanger-P1A B-HW1	B	0 s	Malfunction Exchanger pump P1A or P1B HW1
67	Malfunction Circulation-P1A B-HW1	B	0 s	Malfunction Circulation pump P1A or P1B HW1
68	Deviation Supply HW1	A	60 min	Supply temperature HW1 deviates too much from the setpoint for too long
69	Deviation Tank HW1	A	60 min	Tank temperature HW1 deviates too much from the setpoint for too long
70	Malfunction Tank P1A&B-HW1	A	0 s	Malfunction in both tank pumps, P1A and P1B, in HW1
71	Malfunction Exchanger P1A&B-HW1	A	0 s	Malfunction in both exchanger pumps, P1A and P1B, in HW1
72	Malfunction CirculationP1A&B-HW1	A	0 s	Malfunction in both circulation pumps, P1A and P1B, in HW1
73	HW1 manual	C	0 s	HW1 in manual running mode
74	Frost HW1	A	0 s	HW1 frost protection active
75	High temp HW1	B	300 s	HW1 temperature too high
76	Sensor error HW1 supply	B	0 s	Power failure or short-circuit sensor HW1 supply
77	Sensor error HW1 Tank Middle	B	0 s	Power failure or short-circuit sensor HW1 tank middle
78	Sensor error HW1 Tank Bottom	B	0 s	Power failure or short-circuit sensor HW1 tank bottom
79	Sensor error HW1 Tank Solar	B	0 s	Power failure or short-circuit sensor HW1 tank solar
80	Sensor error HW1 limitation	B	0 s	Power failure or short-circuit sensor HW1 limitation
81	Sensor error HW1 Circulation Return Temp	B	0 s	Power failure or short-circuit sensor HW1 circulation return
82	HW1 Alarm Disinfection	A	0 s	HW1 alarm thermal disinfection
83	HW1 Flow switch	A	0 s	HW1 no flow detected

D.6 Hot water 2

No	Alarm text	Prio	Delay	Description
84	Malfunction Tank-P1A B-HW2	B	0 s	Malfunction Tank pump P1A or P1B HW2
85	Malfunction Exchanger-P1A B-HW2	B	0 s	Malfunction Exchanger pump P1A or P1B HW2
86	Malfunction Circulation-P1A B-HW2	B	0 s	Malfunction Circulation pump P1A or P1B HW2

No	Alarm text	Prio	Delay	Description
87	Deviation Supply HW2	A	60 min	Supply temperature HW2 deviates too much from the setpoint for too long
88	Deviation Tank HW2	A	60 min	Tank temperature HW2 deviates too much from the setpoint for too long
89	Malfunction Tank P1A&B-HW2	A	0 s	Malfunction in both tank pumps, P1A and P1B, in HW2
90	Malfunction Exchanger P1A&B-HW2	A	0 s	Malfunction in both exchanger pumps, P1A and P1B, in HW2
91	Malfunction Circulation P1A&B-HW2	A	0 s	Malfunction in both circulation pumps, P1A and P1B, in HW2
92	HW2 manual	C	0 s	HW2 in manual running mode
93	Frost HW2	A	0 s	HW2 frost protection active
94	High temp HW2	B	300 s	HW2 temperature too high
95	Sensor error HW2 supply	B	0 s	Power failure or short-circuit sensor HW2 supply
96	Sensor error HW2 Tank Middle	B	0 s	Power failure or short-circuit sensor HW2 tank middle
97	Sensor error HW2 Tank Bottom	B	0 s	Power failure or short-circuit sensor HW2 tank bottom
98	Sensor error HW2 Tank Solar	B	0 s	Power failure or short-circuit sensor HW2 tank solar
99	Sensor error HW2 limitation	B	0 s	Power failure or short-circuit sensor HW2 limitation
100	Sensor error HW2 Circulation Return Temp	B	0 s	Power failure or short-circuit sensor HW2 circulation return
101	HW2 Alarm Disinfection	A	0 s	HW2 alarm thermal disinfection
102	HW2 Flow switch	A	0 s	HW2 no flow detected

D.7 District heating

No	Alarm text	Prio	Delay	Description
103	Malfunction P1A B-DHS1	B	0 s	Malfunction pump P1A or P1B DHS1
104	Deviation Supply DHS1	A	60 min	Supply temperature DHS1 deviates too much from the setpoint for too long
105	Malfunction P1A&B-DHS1	A	0 s	Malfunction both circulation pumps, P1A and P1B, in DHS1
106	DHS1 manual	C	0 s	DHS1 in manual running mode
107	Frost DHS1	A	0 s	DHS1 frost protection active
108	Sensor error DHS1 supply	B	5 s	Power failure or short-circuit, supply temperature sensor DHS1
109	Sensor error DHS1 return	B	5 s	Power failure or short-circuit, return temperature sensor DHS1
110	Sensor error DHS1 external demand	B	5 s	Power failure or short-circuit, external demand sensor DHS1
111	DHS1 high supply temp	A	300 s	DHS1 high supply temp

D.8 Boiler circuit

No	Alarm text	Prio	Delay	Description
112	Boiler alarm	A	0 s	Boiler alarm
113	Boiler manual	C	0 s	Boiler in manual running mode
114	Sensor error boiler supply	B	5 s	Power failure or short-circuit, boiler supply sensor
115	Sensor error boiler return	B	5 s	Power failure or short-circuit sensor boiler return
116	High boiler temp	A	0 s	Boiler temperature is too high
117	Low boiler temp	A	0 s	Boiler temperature is too low

No	Alarm text	Prio	Delay	Description
118	Low boiler return temp	C	0 s	Return temperature from boiler is too low
119	Pressure/flow error	B	20 s	Pressure or flow error in the boiler circuit
120	Malfunction P1A B transport pump	B	0 s	Malfunction in boiler transport pump P1A or P1B
121	Malfunction P1A&B-transport pump	A	0 s	Malfunction in both transport pumps, P1A and P1B

D.9 Boiler 1

No	Alarm text	Prio	Delay	Description
122	Malfunction P1A B-Boiler 1	B	0 s	Malfunction in pump P1A or P1B Boiler 1
123	Malfunction P1A&P1B-Boiler 1	A	0 s	Malfunction in both pumps, P1A and P1B, in Boiler 1
124	Malfunction Boiler 1	B	0 s	Malfunction in Boiler 1
125	Boiler 1 manual	C	0 s	Boiler 1 in manual mode
126	Sensor error Boiler 1 supply	B	5 s	Power failure or short-circuit, Boiler 1 supply sensor
127	Sensor error Boiler 1 return	B	5 s	Power failure or short-circuit, Boiler 1 return sensor
128	Boiler 1 high supply temp	B	0 s	High supply temperature, Boiler 1
129	Boiler 1 low return temp	C	0 s	Return temperature from Boiler 1 is too low
130	Malfunction P-return Boiler 1	B	0 s	Malfunction in pump P-return Boiler 1

D.10 Boiler 2

No	Alarm text	Prio	Delay	Description
131	Malfunction P1A B-Boiler 2	B	0 s	Malfunction in pump P1A or P1B Boiler 2
132	Malfunction P1A&P1B-Boiler 2	A	0 s	Malfunction in both pumps, P1A and P1B, in Boiler 2
133	Malfunction Boiler 2	B	0 s	Malfunction in Boiler 2
134	Boiler 2 manual	C	0 s	Boiler 2 in manual mode
135	Sensor error Boiler 2 supply	B	5 s	Power failure or short-circuit, Boiler 2 supply sensor
136	Sensor error Boiler 2 return	B	5 s	Power failure or short-circuit, Boiler 2 return sensor
137	Boiler 2 high supply temp	B	0 s	High supply temperature, Boiler 2
138	Boiler 2 low return temp	C	0 s	Return temperature from Boiler 2 is too low
139	Malfunction P-return Boiler 2	B	0 s	Malfunction in pump P-return Boiler 2

D.11 Boiler 3

No	Alarm text	Prio	Delay	Description
140	Malfunction P1A B-Boiler 3	B	0 s	Malfunction in pump P1A or P1B Boiler 3
141	Malfunction P1A&P1B-Boiler 3	A	0 s	Malfunction in both pumps, P1A and P1B, in Boiler 3
142	Malfunction Boiler 3	B	0 s	Malfunction in Boiler 3
143	Boiler 3 manual	C	0 s	Boiler 3 in manual mode
144	Sensor error Boiler 3 supply	B	5 s	Power failure or short-circuit, Boiler 3 supply sensor
145	Sensor error Boiler 3 return	B	5 s	Power failure or short-circuit, Boiler 3 return sensor
146	Boiler 3 high supply temp	B	0 s	High supply temperature, Boiler 3

No	Alarm text	Prio	Delay	Description
147	Boiler 3 low return temp	C	0 s	Return temperature from Boiler 3 is too low
148	Malfunction P-return Boiler 3	B	0 s	Malfunction in pump P-return Boiler 3

D.12 Boiler 4

No	Alarm text	Prio	Delay	Description
149	Malfunction P1A B-Boiler 4	B	0 s	Malfunction in pump P1A or P1B in Boiler 4
150	Malfunction P1A&P1B-Boiler 4	A	0 s	Malfunction in both pumps, P1A and P1B, in Boiler 4
151	Malfunction Boiler 4	B	0 s	Malfunction in Boiler 4
152	Boiler 4 manual	C	0 s	Boiler 4 in manual mode
153	Sensor error Boiler 4 supply	B	5 s	Power failure or short-circuit, Boiler 4 supply sensor
154	Sensor error Boiler 4 return	B	5 s	Power failure or short-circuit, Boiler 4 return sensor
155	Boiler 4 high supply temp	B	0 s	High supply temperature, Boiler 4
156	Boiler 4 low return temp	C	0 s	Return temperature from Boiler 4 is too low
157	Malfunction P-return Boiler 4	B	0 s	Malfunction in pump P-return Boiler 4

D.13 Buffer

No	Alarm text	Prio	Delay	Description
158	Malfunction P1A B-HP1	B	0 s	Malfunction in pump P1A or P1B HP1
159	Malfunction P1A & P1B-HP1	A	0 s	Malfunction in both pumps, P1A and P1B, in HP1
160	Malfunction P1A B-HP1 add heat source	B	0 s	Malfunction pump P1A or P1B HP1 add heat source
161	Malfunction P1A & P1B-HP1 add heat source	A	0 s	Malfunction both pumps P1A and P1B in HP1 add heat source
162	HP1 manual	C	0 s	HP1 in manual running mode
163	HP1 Alarm max temp buffer	A	300 s	Buffer temperature is too high
164	Sensor error HP1 Tank Top	B	5 s	Power failure or short-circuit sensor HP1 tank top
165	Sensor error HP1 Tank Bottom	B	5 s	Power failure or short-circuit sensor HP1 tank bottom
166	Sensor error HP1 external demand	B	5 s	Power failure or short-circuit, external demand sensor HP1
167	Sensor error HP1 add. heat source	B	5 s	Power failure or short-circuit, additional heat source sensor HP1

D.14 Solar

No	Alarm text	Prio	Delay	Description
168	Malfunction P1A B-SO1	B	0 s	Malfunction in pump P1A or P1B SO1
169	Malfunction P1A & P1B-SO1	A	0 s	Malfunction in both pumps, P1A and P1B, in SO1
170	SO1 manual	C	0 s	SO1 in manual running mode
171	High temp collector SO1	A	0 s	High temperature collector SO1
172	Frost collector SO1	A	0 s	Frost collector SO1
173	Sensor error SO1 Collector	B	5 s	Power failure or short-circuit, SO1 collector sensor
174	Sensor error SO1 Return	B	5 s	Power failure or short-circuit, SO1 collector return sensor

D.15 Differential pressure

No	Alarm text	Prio	Delay	Description
175	Pressure manual	C	0 s	Pressure control in manual running mode
176	Sensor error pressure	B	5 s	Incorrect signal pressure transmitter

D.16 Consumption

No	Alarm text	Prio	Delay	Description
177	High cold water consumption/day	B	0 s	24 hour cold water usage higher than limit
178	High energy usage	B	0 s	24 hour energy usage higher than set limit
179	High cold water consumption/h	B	0 s	Cold water usage/hour higher than set limit

D.17 Refill

No	Alarm text	Prio	Delay	Description
180	Pressure low	B	0 s	Pressure lower than normal, but still high enough
181	Pressure very low	B	0 s	Very low pressure
182	Pressure critical low	A	0 s	Critical low pressure

D.18 Miscellaneous

No	Alarm text	Prio	Delay	Description
183	Sensor error outdoor temp	B	5 s	Sensor error outdoor temp
184	Sensor error outdoor temp HS2	B	5 s	Power failure or short-circuit, outdoor temperature sensor HS2
185	Sensor error outdoor temp HS3	B	5 s	Power failure or short-circuit, outdoor temperature sensor HS3
186	Sensor error outdoor temp HS4	B	5 s	Power failure or short-circuit, outdoor temperature sensor HS4
187	Sensor error extra sensor 1	B	5 s	Power failure or short-circuit extra sensor 1
188	Sensor error extra sensor 2	B	5 s	Power failure or short-circuit extra sensor 2
189	Sensor error extra sensor 3	B	5 s	Power failure or short-circuit extra sensor 3
190	Sensor error extra sensor 4	B	5 s	Power failure or short-circuit extra sensor 4
191	Sensor error extra sensor 5	B	5 s	Power failure or short-circuit extra sensor 5
192	Sensor error wind	B	5 s	Incorrect signal wind speed transmitter
193	Sensor error HP supply	B	5 s	Power failure or short-circuit sensor HP supply
194	Sensor error HP return	B	5 s	Power failure or short-circuit sensor HP return
195	Sensor error CP supply	B	5 s	Power failure or short-circuit sensor CP supply
196	Sensor error CP return	B	5 s	Power failure or short-circuit sensor CP return
197	Malfunction frequency converter	B	0 s	Malfunction frequency converter
198	Expansion vessel	A	60 s	Malfunction expansion vessel
200	P1-freq manual	C	0 s	P1-frequency controlled in manual running mode
201	Internal battery error	B	0 s	Internal battery needs replacing
202	Communication error expansion unit 1	B	0 s	Communication interrupted between expansion unit 1 and master controller

Alarm list

No	Alarm text	Prio	Delay	Description
203	Communication error expansion unit 2	B	0 s	Communication interrupted between expansion unit 2 and master controller
204	Communication error M-Bus HM HS1	B	0 s	M-Bus communication fault between master and heat meter HS1
205	Communication error M-Bus HM HS2	B	0 s	M-Bus communication fault between master and heat meter HS2
206	Communication error M-Bus HM HS3	B	0 s	M-Bus communication fault between master and heat meter HS3
207	Communication error M-Bus HM HS4	B	0 s	M-Bus communication fault between master and heat meter HS4
208	Communication error M-Bus HM HW1	B	0 s	M-Bus communication fault between master and heat meter HW1
209	Communication error M-Bus HM HW2	B	0 s	M-Bus communication fault between master and heat meter HW2
210	Communication error M-Bus HM DHS1	B	0 s	M-Bus communication fault between master and heat meter DHS1
211	Communication error M-Bus HM WM1	B	0 s	M-Bus communication fault between master and water meter 1
212	Communication error M-Bus HM WM2	B	0 s	M-Bus communication fault between master and water meter 2
213	Communication error wireless sensors	B	0 s	M-Bus communication fault between master and wireless sensors
214	Communication error Modbus pump 1	B	0 s	Communication fault between master and Modbus pump 1
215	Communication error Modbus pump 2	B	0 s	Communication fault between master and Modbus pump 2
216	Communication error Modbus pump 3	B	0 s	Communication fault between master and Modbus pump 3
217	Communication error Modbus pump 4	B	0 s	Communication fault between master and Modbus pump 4
218	Communication error Modbus pump 5	B	0 s	Communication fault between master and Modbus pump 5
219	Communication error Modbus pump 6	B	0 s	Communication fault between master and Modbus pump 6
220	Communication error Modbus pump 7	B	0 s	Communication fault between master and Modbus pump 7
221	Communication error Modbus pump 8	B	0 s	Communication fault between master and Modbus pump 8
222	Communication error Modbus pump 9	B	0 s	Communication fault between master and Modbus pump 9
223	Communication error Modbus pump 10	B	0 s	Communication fault between master and Modbus pump 10
224	Extra alarm 1	B	0 s	Extra alarm 1
225	Extra alarm 2	B	0 s	Extra alarm 2
226	Extra alarm 3	B	0 s	Extra alarm 3
227	Extra alarm 4	B	0 s	Extra alarm 4
228	Extra alarm 5	B	0 s	Extra alarm 5
229	Extra alarm 6	B	0 s	Extra alarm 6
230	Extra alarm 7	B	0 s	Extra alarm 7
231	Extra alarm 8	B	0 s	Extra alarm 8
232	Extra alarm 9	B	0 s	Extra alarm 9
233	Extra alarm 10	B	0 s	Extra alarm 10

Appendix E Terminal lists

E.1 Exigo Ardo (24 V models)

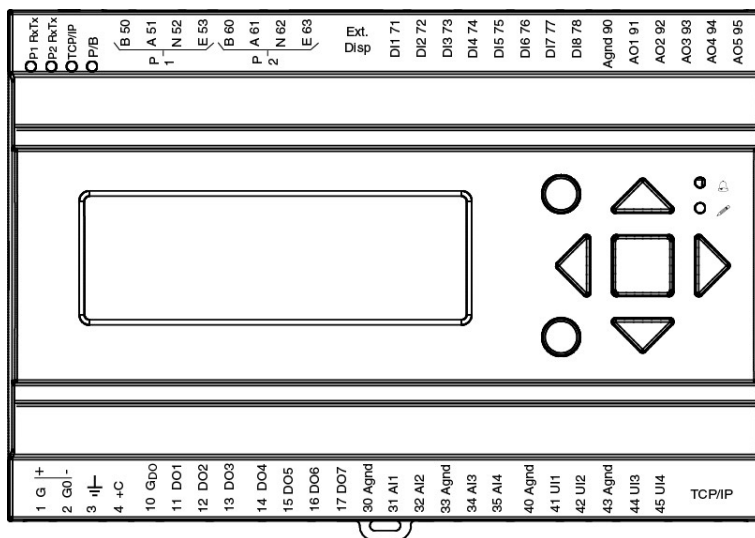

Terminal	I/O	Hardware model		Notes
		A15	A28	
1	Power supply G+	✓	✓	
2	Power supply G0-	✓	✓	
3	Earth	✓	✓	
4	DI common +C	✓	✓	
10	DO common GDO	✓	✓	
11	DO1	✓	✓	
12	DO2	✓	✓	
13	DO3	✓	✓	
14	DO4	✓	✓	
15	DO5	-	✓	
16	DO6	-	✓	
17	DO7	-	✓	
30	Analogue ground	✓	✓	
31	AI1	✓	✓	
32	AI2	✓	✓	
33	Analogue ground	✓	✓	
34	AI3	✓	✓	
35	AI4	✓	✓	
40	Analogue ground	✓	✓	
41	UAI1	-	✓	
42	UAI2	-	✓	
43	Analogue ground	✓	✓	
44	UAI3	-	✓	
45	UAI4	-	✓	
50	Port 1 B	✓*	✓*	
51	Port 1 A	✓*	✓*	
52	Port 1 N	✓*	✓*	
53	Port 1 E	✓*	✓*	

Terminal lists

60	Port 2 B	✓*	✓*	
61	Port 2 A	✓*	✓*	
62	Port 2 N	✓*	✓*	
63	Port 2 E	✓*	✓*	
71	DI1	✓	✓	
72	DI2	✓	✓	
73	DI3	✓	✓	
74	DI4	✓	✓	
75	DI5	-	✓	
76	DI6	-	✓	
77	DI7	-	✓	
78	DI8	-	✓	
80	Analogue ground	✓	✓	
81	AO1	✓	✓	
82	AO2	✓	✓	
83	AO3	✓	✓	
84	AO4	-	✓	
85	AO5	-	✓	

* depending on model

E.2 Exigo Vido (230 V models)

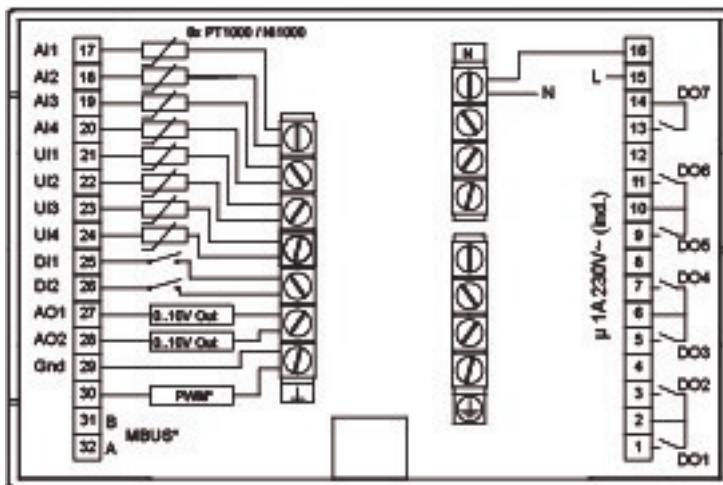

Terminal	I/O	Hardware model		Notes
		A15	A28	
1	DO1	✓	✓	
2	Common DO1/DO2	✓	✓	
3	DO2	✓	✓	
4	-	-	-	
5	DO3	✓	✓	
6	Common DO3/DO4	✓	✓	
7	DO4	✓	✓	
8	-	-	-	
9	DO5	✓	✓	
10	Common DO5/DO6	✓	✓	
11	DO6	✓	✓	

12	-	-	-	
13	DO7	✓	✓	
14	Common DO7	✓	✓	
15	Power supply L	✓	✓	
16	Power supply N	✓	✓	
17	AI1	✓	✓	
18	AI2	✓	✓	
19	AI3	✓	✓	
20	AI4	✓	✓	
21	UAI1	✓	✓	
22	UAI2	✓	✓	
23	UAI3	✓	✓	
24	UAI4	✓	✓	
25	DI1	✓	✓	
26	DI2	✓	✓	
27	UA1	✓	✓	
28	UA2	✓	✓	
29	Analogue ground	✓	✓	
30	AO3	-	✓	
31	MBUS A	✓*	✓	
32	MBUS B	✓*	✓	

* depending on model



HEAD OFFICE AB Regin, Box 116, SE-428 22 Källered • Visiting address: Bangårdsvägen 35, SE-428 36 Källered
Phone: +46 (0)31 720 02 00 • Fax: +46 (0)31 720 02 50 • info@regincontrols.com • www.regincontrols.com