



industrie
technik®

INSTRUCTION MANUAL

ROOM CONTROLLER
EVOLUTION SPLIT
THS2 SERIES



INDEX

1. Technical features	6
Display unit: THS2 (optional)	6
Remote unit: THS2-0MM	6
2. Internal Modbus network	7
3. External Modbus network	8
4. Optional THS2 connection	10
5. THS2-0MM connected to THS2 and supervisor contemporaneously	12
6. Regulation sensor	13
7. ON/OFF function on THS2-0MM	16
8. Logic of digital and analogue inputs THS2-0MM	16
Digital slave inputs DI1 and DI2	16
Analogue slave inputs	17
9. Automatic season changeover with water sensor	20
10. Working setpoint, economy and unoccupied holidays mode	21
11. Temperature regulation batteries	24
12. Heating and cooling battery logic	26
2-pipe HEATING regulation ($I\bar{B} \neq 0$)	26
2-pipe COOLING regulation ($I\bar{B} \neq 0$) without mid-season changeover ($M\bar{B}=0$)	27
2-pipe COOLING regulation ($I\bar{B} \neq 0$) with mid-season changeover ($M\bar{B}=1$)	28
4-pipe regulation ($I\bar{B} \neq 1$)	29
13. 3-point valve	32
3-point, 2-pipe HEATING regulation ($I\bar{B} \neq 0$)	32
3-point, 2-pipe COOLING regulation ($I\bar{B} \neq 0$)	32
3-point, 4-pipe regulation ($I\bar{B} \neq 1$)	33
14. Mixed-use valve	34
15. Supplemental battery logics	35
Supplemental modulating battery function:	35
Supplemental on/off battery function:	35
16. Pump	36
17. CO₂-based damper regulation	36
Use of modulating damper:	36
Use of on/off damper:	36
18. Dehumidifier	38
Use of a modulating dehumidifier:	38
Use of an on/off dehumidifier:	38
19. Fan coil unit with EC motor	40
Automatic speed control logic for EC motor with on/off outputs in heating mode	40
Automatic speed control logic for EC motor with on/off outputs in cooling mode	41
Automatic speed control logic for EC motor with 0..10 V or 3-point outputs in heating mode	42
Automatic speed control logic for EC motor with 0..10 V or 3-point outputs in cooling mode	43

20. Fan coil unit with 3-speed on/off motor	44
Automatic speed control logic for 3-speed on/off motors with 0..10 V or 3-point outputs in heating mode	44
Automatic speed control logic for 3-speed on/off motors with 0..10 V or 3-point cooling outputs	45
Automatic speed control logic for 3-speed on/off motors with on/off outputs in heating mode	46
Automatic speed control logic for 3-speed on/off motors with on/off outputs in cooling mode	47
21. Manual speeds and ventilation in the absence of regulation	48
22. Fan boost	48
23. Minimum thermostat	48
24. Destratification cycle	49
25. Window contact	49
26. Frost protection function of the heating battery	49
27. Dirty filter	50
28. Summertime changeover	50
29. Remote setpoint variator	51
30. Restoring default parameters	51
31. Optional THS2	52
32. Display, keypad and icons of THS2	52
33. Setting parameters using quick access on THS2	54
Keypad lock	54
Global on/off	54
Setting the setpoint and offset setpoint	55
Fan operating mode	55
MODE key function	56
34. Timer extension or forced presence mode	58
35. Setting DATE and TIME	59
36. Operation and setting of TIME BANDS	60
37. Duplication of TIME BANDS	62
38. Alarms	63
Communication error counter parameters	64
Resetting of internal network communication error counter parameters	65
39. Setting configuration parameters (level 1 password)	66
40. Setting setpoints parameters (level 2 password)	72
41. Setting THS2 parameters (level 3 password)	74
42. Setting CN4 communication parameters (level 4 password)	76
43. Logic of digital inputs THS2	77
Digital THS2 inputs DI1 and DI2	77
44. Input/output status of THS2-0MM connected to THS2	77
45. Display of THS2-0MM operating by THS2 connected	80
46. Monitoring status internal network (from THS2)	81
47. Restoring default parameters	83
48. Firmware version display	84
49. USB connection	85
50. Jumper configuration	86
51. Forcing digital and analogue slave inputs/outputs	87
Forcing outputs	87
Forcing inputs	88
52. THS2-0MM master Modbus variables	90
53. Electrical connections	113
THS2-0MM unit connection	113
THS2 unit connection	116

54. Networks connection diagram	117
Internal network connection diagram without supervisor on CN4	117
Internal network connection diagram with supervisor on CN4	117
External MODBUS network connection diagram with supervisor on CN5	119
Connection between optional THS2 to THS2-0MM	121
55. Dimensions	122
THS2-0MM unit	122
THS2 unit	122
56. Installation requirements	123
THS2-0MM unit installation	124
THS2 unit installation	125

1. Technical features

• Display unit: THS2 (optional)

Power supply:	5 Vdc provided by THS2-0MM
Ambient temperature:	0...50°C
Display:	LCD display with backlight
Inputs:	2 potential-free contacts SELV (limit of voltage: 5 Vdc) USB for configuration and software update
Communication:	external network
Dimensions:	128 x 80 x 28.5 mm
Installation:	wall mounting
Protection class:	2
CE compliance standards:	EN 60730-1

• Remote unit: THS2-0MM

Power supply:	110...240 Vac, 50/60 Hz
Power consumption:	max 1.1 W (3.5 VA) THS2-0MM (with THS2 connected)
Ambient temperature:	0...40°C
Inputs:	2 potential-free contacts SELV (limit of voltage: 4 Vdc) 2 NTC10K sensors USB for software update
Outputs:	3 analogue outputs 0-10 V ($R_L > 10K$) 5 SPST 240 Vac relays. K1 K2 K3 combined total 3 A (AC1), K5 K6 each 1 A (AC1) 1 SPST 240 Vac, 10 A (AC1) relay K4
Connections:	max. cross-sectional area 1.5 mm ² (flexible cord conductors)
Communication:	one external network Modbus RTU (slave) for BMS, configuration or display. One internal network for connection up to 15 units.
Dimensions:	140 x 121,5 x 47 mm
Protection class:	2
Mode of operation:	type 1
Rated impulse voltage:	2.5 kV
Control pollution degree:	2
Low voltage directive LVD:	EN 60730-1
CE compliance standards:	EN 60730-1

2. Internal Modbus network

The internal Modbus network consists of:

- a master unit which allows the operating parameters of each slave and the master itself to be set
- 1 to 14 slave units: the parameter $M20$ is the sum of the number of slaves and master unit (on the example below $M20=15$)
- an optional humidity and CO₂ transmitter whose presence is defined by parameter $M21$.

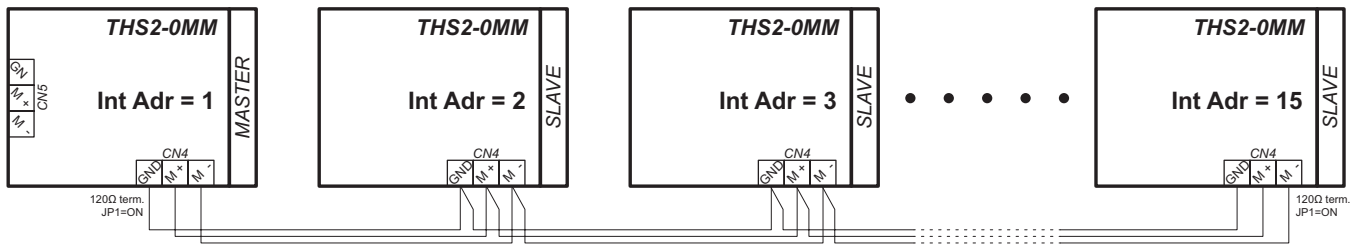

The minimum configuration of the internal network consists of 1 master without slave ($M20=1$).

The maximum configuration of the internal network consists of 1 master unit connected to 14 slave units ($M20=15$).

Addresses are set for all units by means of a SW3 rotary dip switch located on each slave card (see [“53. Electrical connections” page 113](#)).



Address A=10, B=11, C=12, D=13, E=14, F=15, address 0 is not valid and must not be selected.

Each unit, included the master unit must have an address different from other units and different from 0. The master or slave can have any address between 1 and F.

In case less than 15 units (14 slaves + 1 master) are used, parameter $M20$ must be equal to the total of units present in the internal network.

It is mandatory to assign an address different for each unit and on the range from 1 to the value of parameter $M20$.

The unit that is master must have jumper J1 ON, the slaves jumper J1 OFF (not mounted). It is not possible to set 2 units in the same internal network as master otherwise communication could not takes place.

J2	<input type="checkbox"/>	OFF (Ext Adr = Int Adr = SW3)
J2	<input checked="" type="checkbox"/>	ON (Ext Adr = M19)

Parameter $M20$ can be set either by an optional THS2 unit connected on CN5 of master unit (with password 33) or by Modbus connecting a supervisor on CN5 and setting the variable `ADR_MOD_MAX_UNITS_INTERNAL_NETWORK` (11150).

To connect a supervisor for the first time on CN5 connector use the address set on rotary switch of the master unit for internal network (jumper J2 must be OFF) with baud rate 19200 bit/s, parity even.

3. External Modbus network

The external Modbus network allows the connection of a supervisor to the internal network via master unit with a second communication port.

It is possible to connect several internal networks to the same supervisor by assigning a different address to each master in the external network.

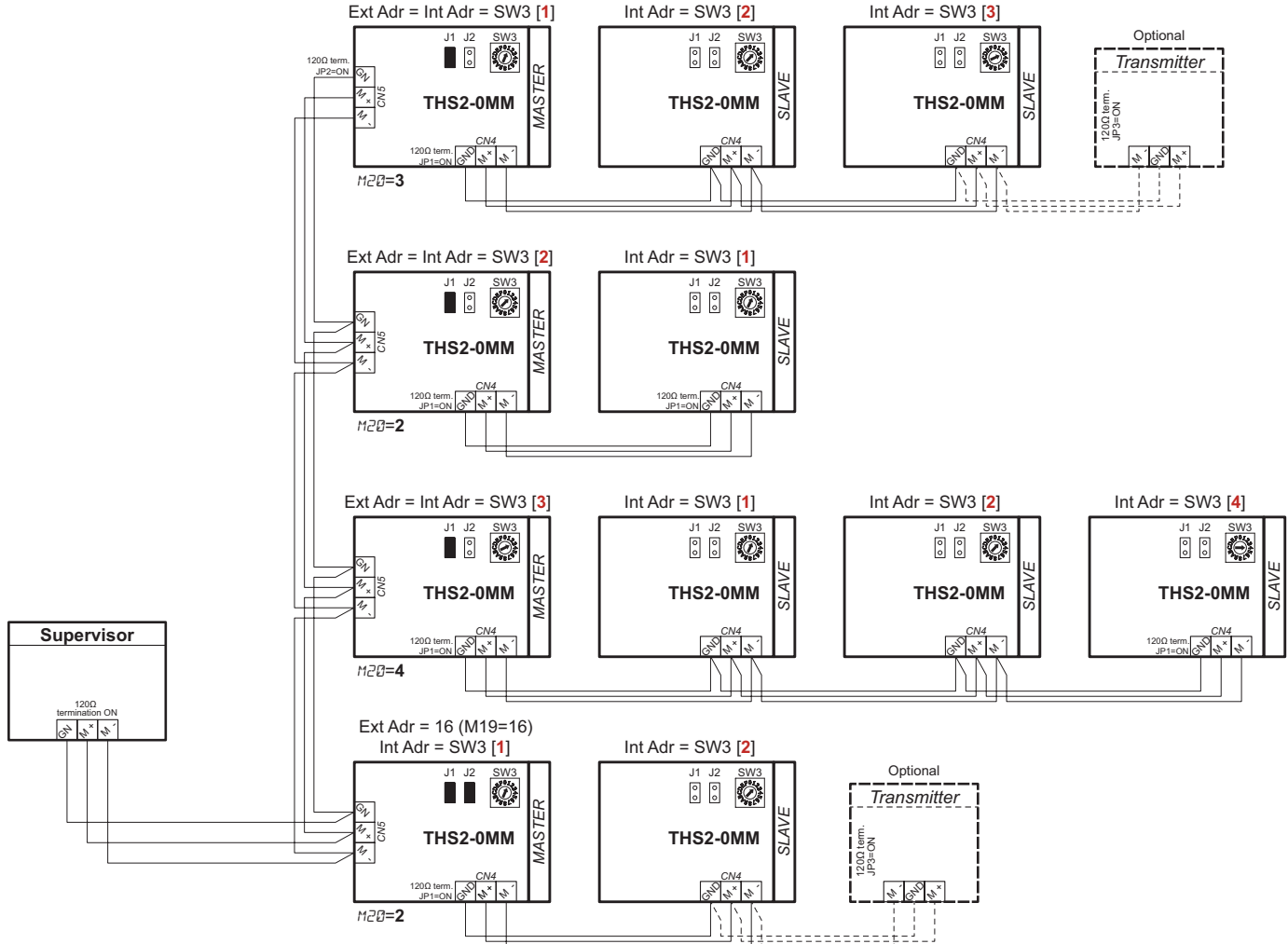

When jumper J2 is not mounted, the address set on rotary switch SW3 is the same for internal and external network. (Parameter M 19 is also set to this value).

Connection to supervisor system can be faster for several internal networks as it is not necessary to set external address with parameter M 19.





For higher number of internal networks to connect to supervisor, external address of each master unit must be set by following procedure:

Put jumper J2 in ON position.





J2		OFF (Ext Adr = Int Adr = SW3)
J2		ON (Ext Adr = M19)

if a THS2 is connected to the master set parameter *M 19* to the desired address and exit parameters setting to transfer the new address to master unit.

If a THS2 is not connected to the THS2-0MM master, connect supervisor on CN5 and set new address on variable **ADR_MOD_MODBUS_ADDRESS_NETWORK** (11149). Before changing address the connection must be done with the address set on SW3.

After the THS2-0MM master takes into consideration the new address, it is necessary for THS2 (or supervisor) to establish a connection with the new address set. Press the keys  +  simultaneously, the following message appears on the display:

play: 

Press the  key the current address is flashing. With keys  or  select the new address and press the  key to save the selection, then the  key to exit connection address setting.

Example of assignment done for the following network:

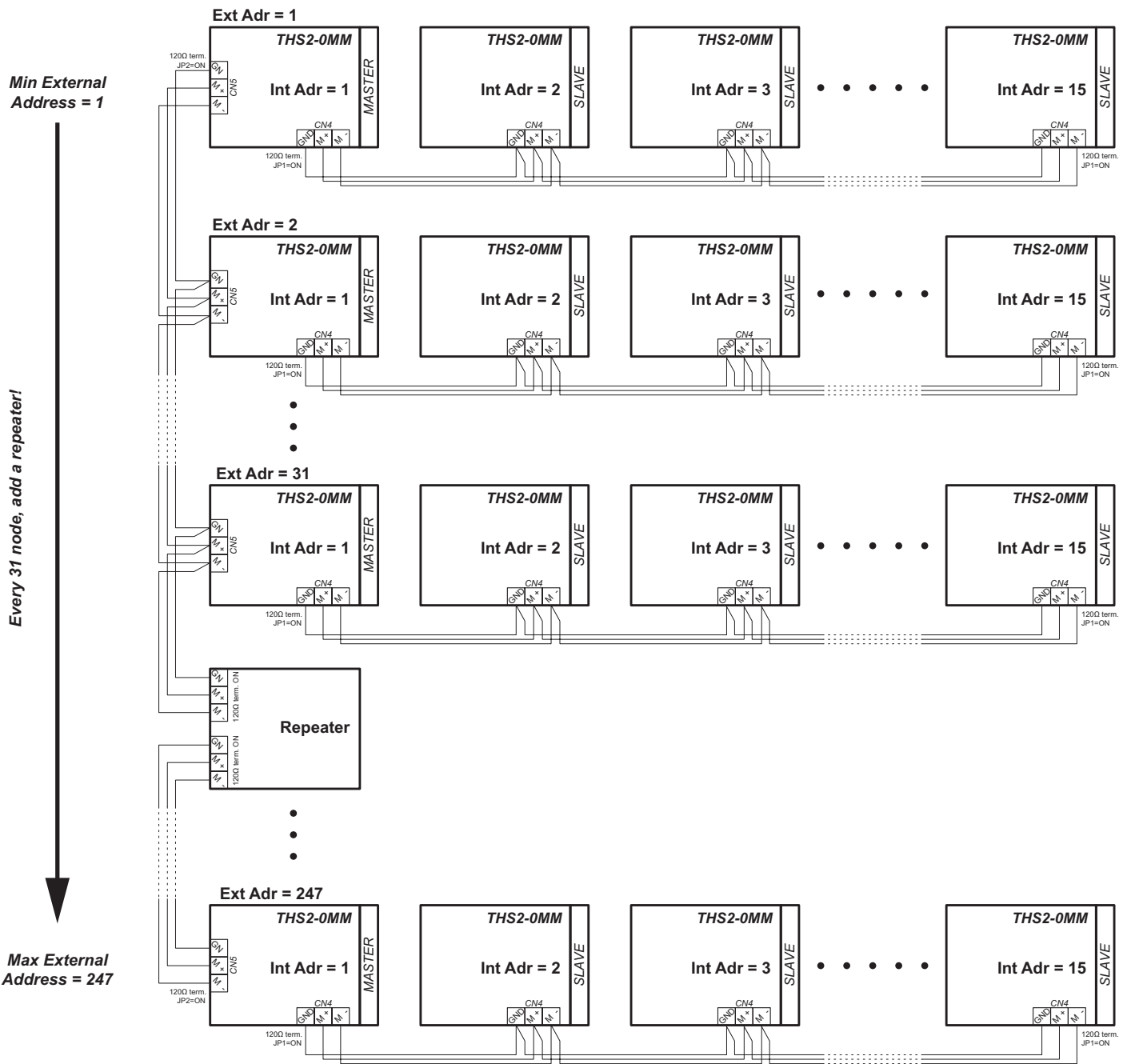

The supervisor can monitor all status of each master, and several status variables of slaves, set the operating parameters for each internal network. If necessary, it can sets inputs, outputs of devices of the same internal network independently from regulation.

The supervisor must exchange data with each master with a time laps lower than 10 minutes to be considered as connected by master otherwise change of parameters done by supervisor are not considered.

Note: in case of change of parameters for baud rate, parity on external network, make change on master unit from supervisor or on a THS2 connected to CN5 of master unit. Automatically all units connected to master unit will change parameters setting for communication on external network and after the change done, the supervisor and each THS2 connected to slaves of internal network will have to update communication parameters to the new ones to be able to communicate again.

4. Optional THS2 connection

If no supervisor is used an optional display THS2 can be connected to a master on the second Modbus communication port (CN5 connector) for monitoring operating mode of master unit and set all parameters. The master unit transmits the same setting to the whole slaves of internal network.

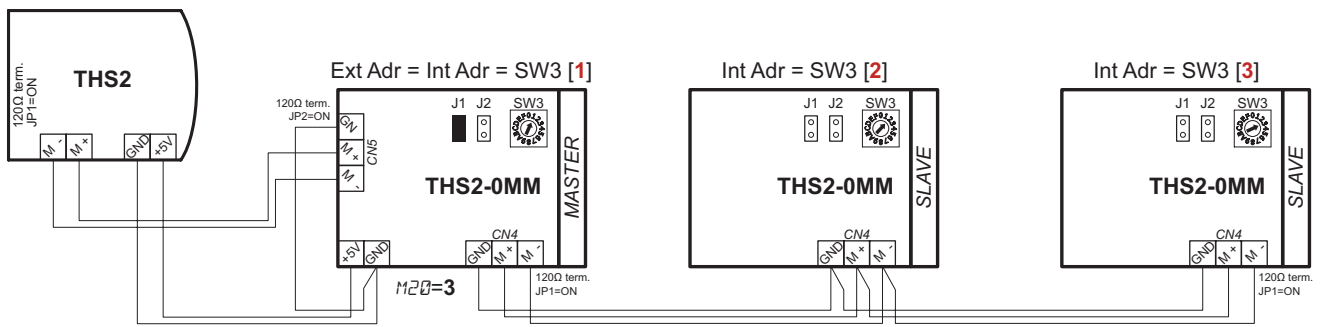

Connect GN and GND on this case.

If a supervisor is connected to the master unit, an optional display THS2 can be connected to a slave on the second Modbus communication port (CN5 connector). The optional THS2 can monitor operating mode of the slave at which it is connected and can only change some operating variables such as setpoint or offset setpoint, speed of fan, on/off. These changes will be then set on the whole internal network by the THS2-0MM master unit.

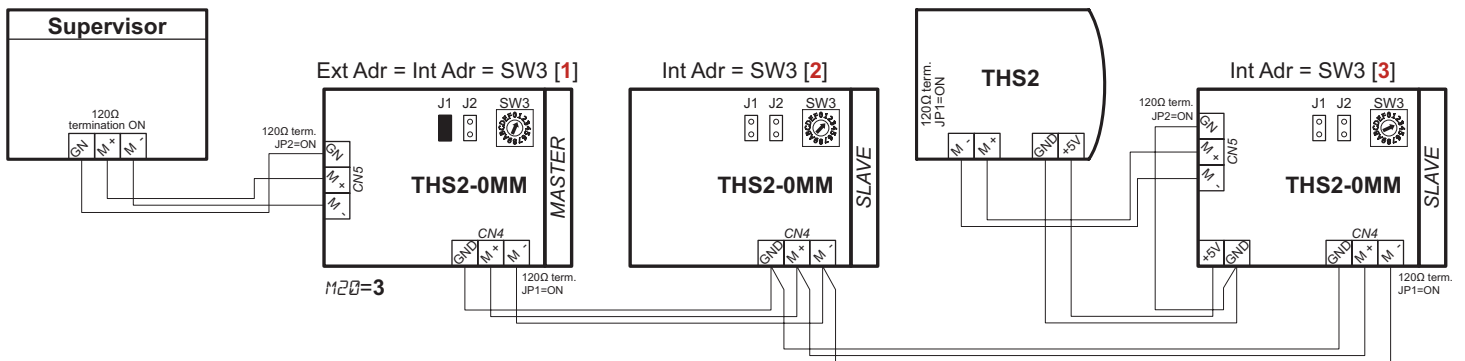

It is also possible to connect more than one THS2 on the second Modbus communication port (CN5 connector), at maximum one per unit THS2-0MM.

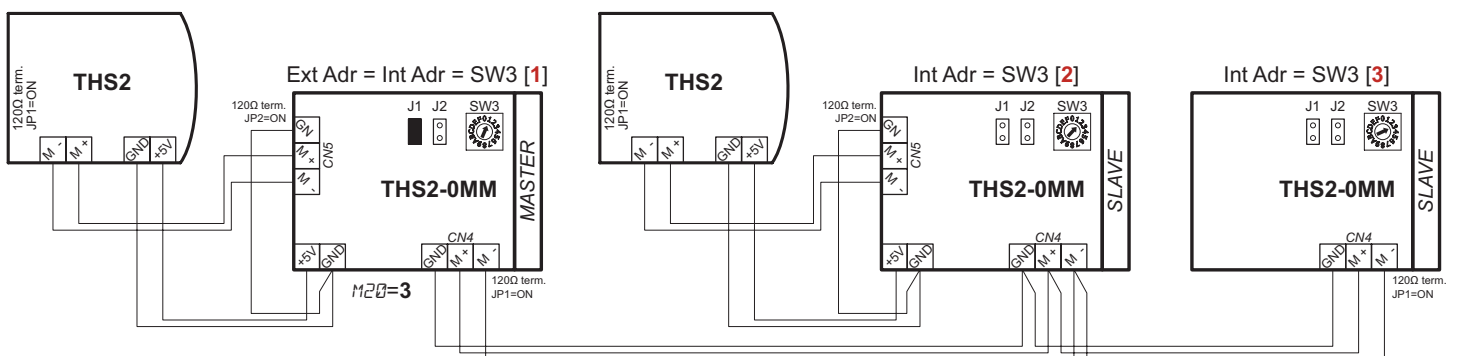

By parameter *M22* it is possible to define what can do THS2 when connected to a THS2-0MM slave unit (see [“31. Optional THS2” page 52](#)).

5. THS2-0MM connected to THS2 and supervisor contemporaneously

it is possible to create a network with several THS2-0MM slave units connected to supervisor system on CN4 and THS2 unit on CN5.

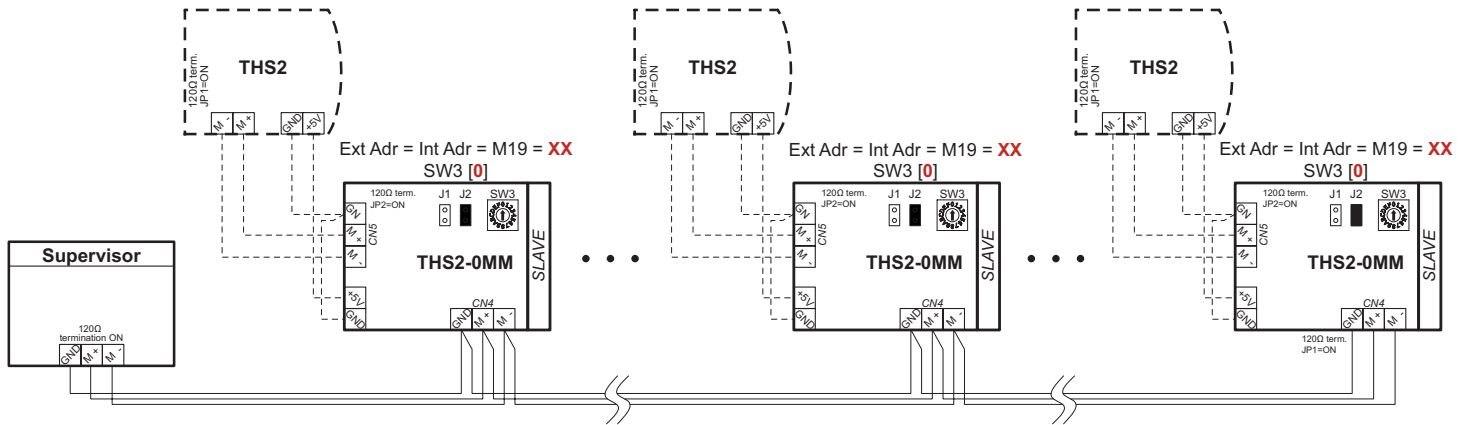

To create such a network, the following settings must be done on all THS2-0MM units:

- jumper J1 must be OFF (not mounted), by this way all units are slaves.
- the position of SW3 must be put on 0, by default the address on CN4 and CN5 becomes 1.
- jumper J2 must be ON (mounted).

By parameter *M 19* the address of a THS2-0MM unit must be set between 1 and 247. This address is the same for CN4 (internal network) and CN5 (external Modbus connection towards display THS2) and must be different for each unit.

It is advisable to connect a THS2-0MM one by one and do the settings indicated.

After connection has been established write on variable **STATUS_PRESENCE_MASTER** (11038) the value **5555** to indicate the presence of the master unit.

it is necessary for supervisor to communicate with each slave with a time lapse lower than 10 minutes otherwise a slave will consider the supervisor unconnected.

if a THS2 is connected to the THS2-0MM slave, set parameter *M 19* to the desired address and exit parameters setting to transfer the new address to the slave unit or connect supervisor on CN4 and set new address on variable **ADR_MOD_MODBUS_ADDRESS_NETWORK** (11149) (default baud rate=9600bit/s with even parity and address 1).

After the THS2-0MM slave takes into consideration the new address, it is necessary for THS2 (and supervisor) to establish the connection with the new address set. For THS2 press the keys + simultaneously, the following message appears

Adr
1

on the display:

Press the key the current address is flashing. With keys or select the new address and press the key to save the selection, then the key to exit connection address setting.

6. Regulation sensor

A wide choice can be made when selecting the regulation sensor for a THS2-0MM.

The regulation sensor of a given unit can be:

- it's own remote regulation sensor,
- the internal sensor of optional THS2,
- the remote regulation sensor of master unit.

Selection is made writing the variable **ADR_MODTYPESENSREG** (11070) (parameter $I02$) on master unit.

- If $I02=0$, the respective slave regulation sensor that can be sensor AI1 (or AI2): .

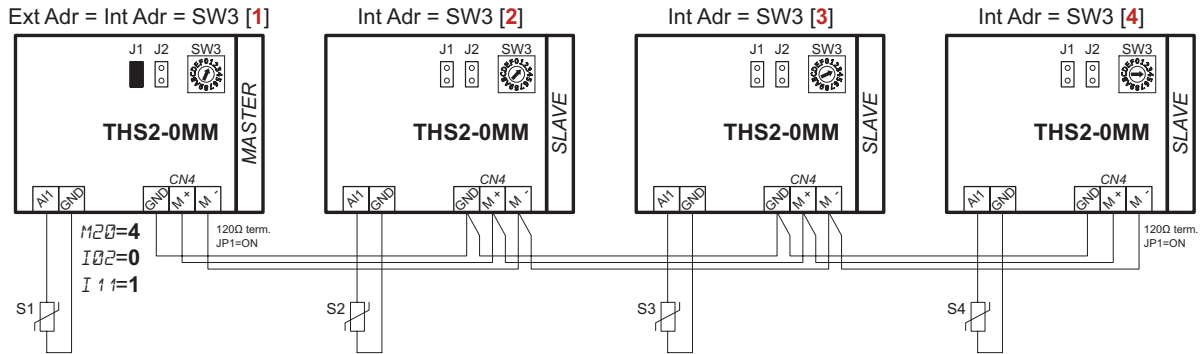

Write 0 on variable **ADR_MODTYPESENSREG** (11070) (parameter $I02$) on master unit.

Write 1 on variable **ADR_MOD_ANAINPUT1FUN** (11079) (parameter $I11$) to set AI1 as regulation sensor on master unit [or **ADR_MOD_ANAINPUT2FUN** (11081) (parameter $I13$) to set AI2].

- If $I02=1$ regulation with internal temperature of optional THS2 connected to master unit for whole network:

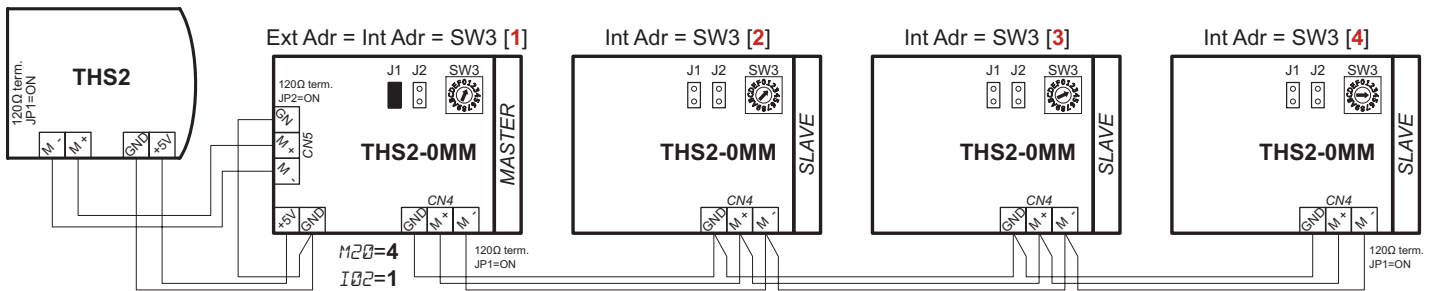

Write 1 on variable **ADR_MODTYPESENSREG** (11070) (parameter $I02$) on master unit.

On THS2 unit set parameter $M22=0$.

- regulation with internal temperature of optional THS2 connected to a slave unit for whole network

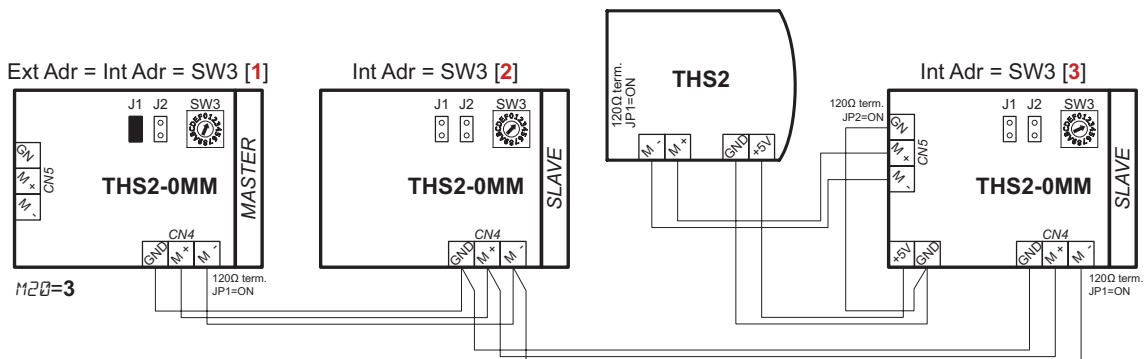

Write 1 on variable **ADR_MODTYPESENSREG** (11070) (parameter $I02$) on master unit.

On THS2 unit set parameter $M22=0$.

- In case several THS2 units are connected to different THS2-0MM units it is possible to select the internal temperature of the THS2 that will be used for whole network (see example below):

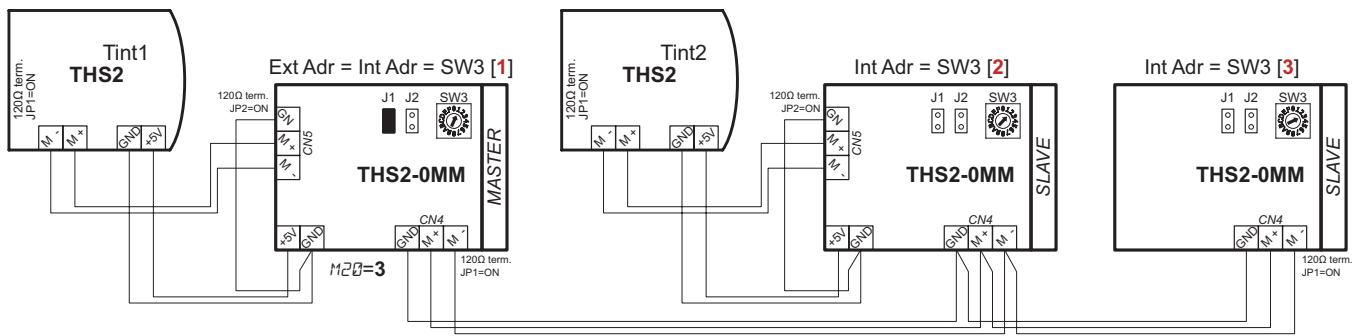

Tint1: internal temperature of THS2 connected to THS2-0MM with address 1
Tint2: internal temperature of THS2 connected to THS2-0MM with address 2

$M22$ [THS2 connected to THS2-0MM with address 1] = 0

$M22$ [THS2 connected to THS2-0MM with address 2] = 0

Regulation temp THS2-0MM [with address 1]=*Tint1*

Regulation temp THS2-0MM [with address 2]=*Tint2*

Regulation temp THS2-0MM [with address 3]=*Tint1* (both THS2 transmit there internal temperature, units of internal network without THS2 connected use the internal temperature of the THS2 connected to the THS2-0MM with lowest internal address).

$M22$ [THS2 connected to THS2-0MM with address 1] = 1

$M22$ [THS2 connected to THS2-0MM with address 2] = 0

Regulation temp THS2-0MM [with address 1]=*Tint2*

Regulation temp THS2-0MM [with address 2]=*Tint2*

Regulation temp THS2-0MM [with address 3]=*Tint2*

$M22$ [THS2 connected to THS2-0MM with address 1] = 0

$M22$ [THS2 connected to THS2-0MM with address 2] = 1

Regulation temp THS2-0MM [with address 1]=*Tint1*

Regulation temp THS2-0MM [with address 2]=*Tint1*

Regulation temp THS2-0MM [with address 3]=*Tint1*

- If a supervisor is connected to master unit instead an optional display, it can send a temperature to the internal network for regulation:

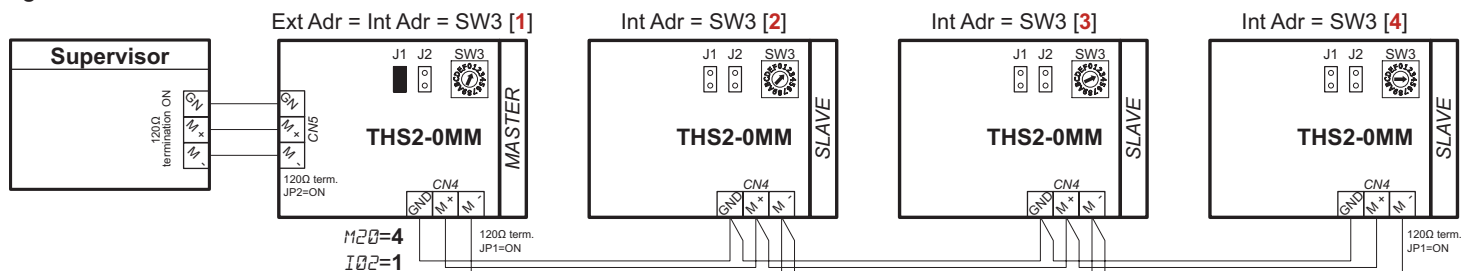

Follow the procedure below on master unit from supervisor:

- write the value **2222** to indicate presence of supervisor on variable **STATUS_PRESENCE_SUPERVISOR_DISPLAY** (11033)

- write the value of temperature multiplied by 10 (for example 255 to transmit a temperature of 25.5°C) on variable **ADR_MOD_STATUS_CURRENT_THS2_TEMP** (11034).

Do not exceed 9 minutes without sending a message from supervisor to master unit otherwise supervisor is considered not connected and temperature is forced to a value corresponding to sensor open (-200).

- If a supervisor is connected to master unit and an optional display on a THS2-0MM unit, the selection of the temperature for regulation depends on the setting done on variable **STATUS_PRESENCE_SUPERVISOR_DISPLAY** (11033) of master unit from supervisor and parameter $M22$ of THS2:

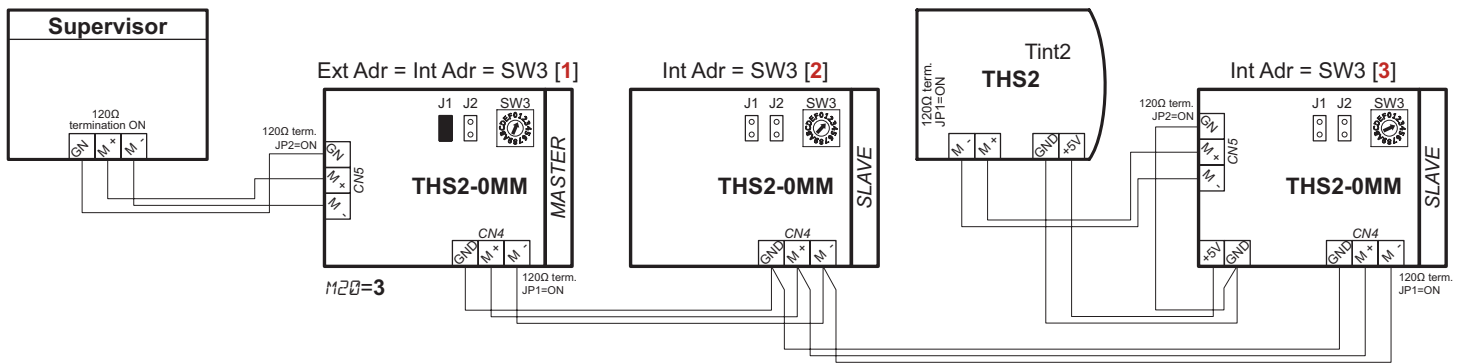

Tint2: internal temperature of THS2 connected to THS2-0MM with address 3

->regulation of all internal network with temperature supplied by supervisor

- write the value **22222** to indicate presence of supervisor on variable **STATUS_PRESENCE_SUPERVISOR_DISPLAY** (11033)
- write the value of temperature multiplied by 10 (for example 255 to transmit a temperature of 25.5°C) on variable **ADR_MOD_STATUS_CURRENT_THS2_TEMP** (11034).

Do not exceed 9 minutes without sending a message from supervisor to master unit otherwise supervisor is considered not connected and temperature is forced to a value corresponding to sensor open (-200).

- set $M22$ [THS2 connected to THS2-0MM with address 3] = 1

->regulation of all internal network with temperature supplied by THS2:

- write the value **11500** to indicate presence of supervisor on variable **STATUS_PRESENCE_SUPERVISOR_DISPLAY** (11033) without transmitting temperature

- set $M22$ [THS2 connected to THS2-0MM with address 3] = 0

■ If $I02=2$ regulation with own remote regulation sensor of master unit

On this case the temperature of sensor connected to A11 (or AI2) is used for regulation by all units of the whole internal network.

Write 2 on variable **ADR_MODTYPESENSREG** (11070) (parameter $I02$) on master unit.

Write 1 on variable **ADR_MOD_ANAINPUT1FUN** (11079) (parameter $I11$) to set A11 as regulation sensor on master unit.

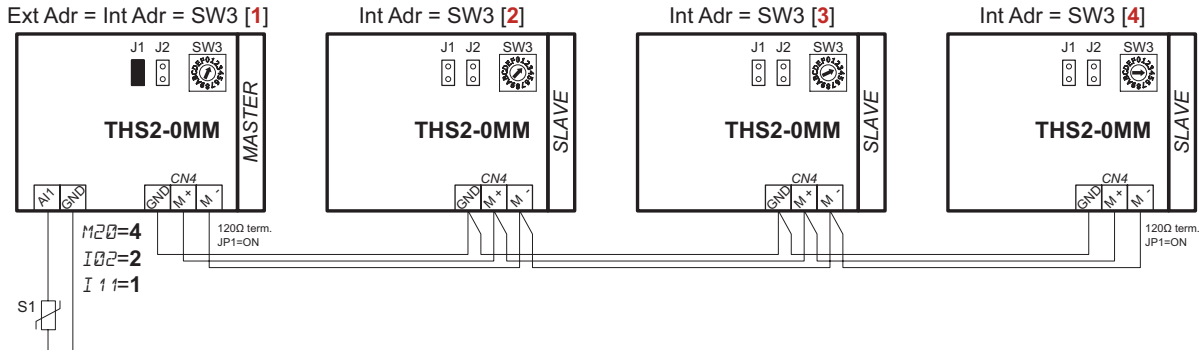

Note: for $I02=0$ or $I02=2$ if a THS2 is connected to a THS2-0MM unit it is also possible to consider the temperature of internal THS2 together with remote regulation sensor of THS2-0MM to obtain the regulation sensor.

Example: to regulate with a weighting of 25% of the remote sensor connected on A11 (or AI2) and a weighting of 75% of the internal sensor of the THS2 with $I02=2$, set the following setting on THS2-0MM unit:

Write 2 on variable **ADR_MODTYPESENSREG** (11070) (parameter $I02$).

Write 1 on variable **ADR_MOD_ANAINPUT1FUN** (11079) (parameter $I11$) to set A11 as regulation sensor.

Write 25 on variable **ADR_MOD_WEIGHTREMAISENS**(11094) (parameter $I25$) to set the weight of remote regulation sensor

The following formula is applied for calculation of regulation sensor:

$T_{reg} = [T_i (100 - Y) + (T_A \times Y)] / 100$ with:

T_i =internal sensor of THS2,

T_A =remote sensor connected on A11 of THS2-0MM,

Y =weight of remote sensor.

For not considering weighting set the parameter $I25$ to 100 (default value).

7. ON/OFF function on THS2-0MM

The THS2-0MM master can be switched on or off by configuring a digital input with remote on/off function $I07=2$ (Input $DI1$) or $I09=2$ (Input $DI2$), by connecting an optional THS2-0MM or by supervisor.

On this last case to put unit in ON write the value 1 to the address **ADR_MOD_FORCE_MASTERGLOBALONOFF** (11048) or 0 to put the unit in OFF. To release the control of ON/OFF from supervisor write the value 200 on the same address.

A THS2-0MM slave can be switch on/off by THS2-0MM master or by an optional THS2 connected.

In case a remote contact is used for on/off function on THS2-0MM master it has high priority if no supervisor system is connected. Even if a THS2 is connected it is not possible to switch on/off manually or by time bands.

If a supervisor system is connected to the THS2-0MM master with a remote on/off contact set, the supervisor has the highest priority for switching on/off internal network by writing 0 (for switching off) or 1 (for switching on) to the address **ADR_MOD_FORCE_MASTERGLOBALONOFF** (11048). To let the contact on/off take the control on master unit for on/off function the supervisor must write the value 200 on address **ADR_MOD_FORCE_MASTERGLOBALONOFF** (11048).

8. Logic of digital and analogue inputs THS2-0MM

• Digital slave inputs DI1 and DI2

Parameter	Logic		
$I07=0$ (Input $DI1$) or $I09=0$ (Input $DI2$)			
Not used			
$I07=1$ (Input $DI1$) or $I09=1$ (Input $DI2$)	Logic $DI1$ $I08 =$ Logic $DI2$ $I10 =$	0	1
Remote contact for season changeover	Summer		
	Winter		
$I07=2$ (Input $DI1$) or $I09=2$ (Input $DI2$)	Logic $DI1$ $I08 =$ Logic $DI2$ $I10 =$	0	1
Remote On/Off (Do not use if a supervisor system is connected to master unit. Supervisor has higher priority and contact is not considered on this case)	Off		
	On		
$I07=3$ (Input $DI1$) or $I09=3$ (Input $DI2$)	Logic $DI1$ $I08 =$ Logic $DI2$ $I10 =$	0	1
Unoccupied	"Unoccupied holidays" mode		
	"occupied" mode		
$I07=4$ (Input $DI1$) or $I09=4$ (Input $DI2$)	Logic $DI1$ $I08 =$ Logic $DI2$ $I10 =$	0	1
Energy saving	No economy		
	Economy		
$I07=5$ (Input $DI1$) or $I09=5$ (Input $DI2$)	Logic $DI1$ $I08 =$ Logic $DI2$ $I10 =$	0	1
Window contact	Window open		
	Window closed		
$I07=6$ (Input $DI1$) or $I09=6$ (Input $DI2$)	Logic $DI1$ $I08 =$ Logic $DI2$ $I10 =$	0	1
Generic alarm	Alarm absent		
	Alarm present		
$I07=7$ (Input $DI1$) or $I09=7$ (Input $DI2$)	Logic $DI1$ $I08 =$ Logic $DI2$ $I10 =$	0	1
Minimum thermostat	Open		
	Closed		

Setting is done either by setting parameters on the optional THS2 connected to master unit or by modbus of master unit and writing the following variables:

ADR_MOD_DIGINPUT1FUN (11075) for setting $I07$

ADR_MOD_DIGINPUT1LOG (11076) for setting $I08$

ADR_MOD_DIGINPUT2FUN (11077) for setting $I09$

ADR_MOD_DIGINPUT2LOG (11078) for setting $I10$

• **Analogue slave inputs**

1. Analogue input 1 (AI1):

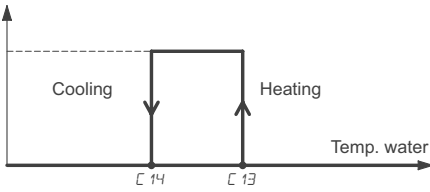
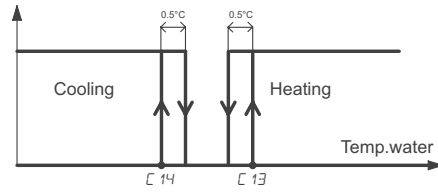
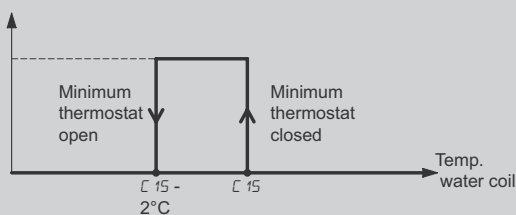
Parameter								
$I 11=0$	Sensor not used							
$I 11=1$ Remote regulation sensor	Sensor AI1 is used to obtain the final regulation temperature (for the calculation, see “6. Regulation sensor” page 13)							
$I 11=2$ Water sensor for season changeover	$\zeta 15=0$ or 1 	$\zeta 15=2$ 						
	If the water sensor temperature at power-on is between $\zeta 14$ and $\zeta 13$ see paragraph “9. Automatic season changeover with water sensor” page 20 for season definition.							
$I 11=3$ Minimum thermostat sensor		<p>If the temperature of the heating battery sensor at power-on is between $\zeta 15$ and $\zeta 15 - 2$, the minimum thermostat is considered open.</p>						
$I 11=4$ Remote contact for season changeover	$I 12 =$	<table border="1"> <tr> <td>0</td> <td>1</td> </tr> <tr> <td></td> <td></td> </tr> <tr> <td></td> <td></td> </tr> </table>	0	1				
0	1							
$I 11=5$ Remote On/Off (Do not use if a supervisor system is connected to master unit. Supervisor has higher priority and contact is not considered on this case)	$I 12 =$	<table border="1"> <tr> <td>0</td> <td>1</td> </tr> <tr> <td></td> <td></td> </tr> <tr> <td></td> <td></td> </tr> </table>	0	1				
0	1							
$I 11=6$ Unoccupied holidays	$I 12 =$	<table border="1"> <tr> <td>0</td> <td>1</td> </tr> <tr> <td></td> <td></td> </tr> <tr> <td></td> <td></td> </tr> </table>	0	1				
0	1							
$I 11=7$ Energy saving	$I 12 =$	<table border="1"> <tr> <td>0</td> <td>1</td> </tr> <tr> <td></td> <td></td> </tr> <tr> <td></td> <td></td> </tr> </table>	0	1				
0	1							
$I 11=8$ Window contact	$I 12 =$	<table border="1"> <tr> <td>0</td> <td>1</td> </tr> <tr> <td></td> <td></td> </tr> <tr> <td></td> <td></td> </tr> </table>	0	1				
0	1							
$I 11=9$ Alarm	$I 12 =$	<table border="1"> <tr> <td>0</td> <td>1</td> </tr> <tr> <td></td> <td></td> </tr> <tr> <td></td> <td></td> </tr> </table>	0	1				
0	1							
$I 11=10$ Remote setpoint variator input	The setpoint variator SAP-NTC-02-2-EV must be connected in order to change the slave setpoint							

For $I 11=4$ to 9 configurations, analogue input 1 is used as a digital input. The contact is considered closed, if there is a short circuit on the analogue input. The contact is considered open, if nothing is connected.

Setting is done either by setting parameters on the optional THS2 connected to master unit or by modbus of master unit and writing the following variables:

ADR_MOD_ANAINPUT1FUN (11079) for setting $I 11$

ADR_MOD_ANAINPUT1LOG (11080) for setting $I 12$

2. Analogue input 2 (AI2):

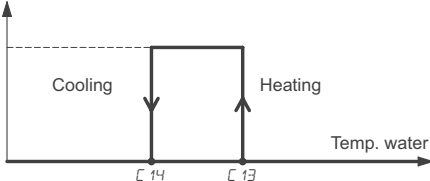
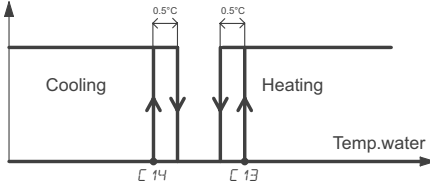
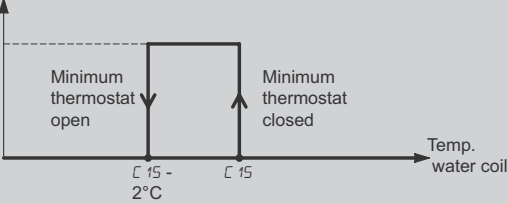
Parameter											
$I_{13}=0$	Sensor not used										
$I_{13}=1$ Remote regulation sensor	Sensor AI2 is used to obtain the final regulation temperature (for the calculation, see " 6. Regulation sensor " page 13)										
$I_{13}=2$ Water sensor for season changeover	$\zeta_{15}=0$ or 1 	$\zeta_{15}=2$ 									
If the water sensor temperature at power-on is between ζ_{14} and ζ_{13} see paragraph " 9. Automatic season changeover with water sensor " page 20 for season definition.											
$I_{13}=3$ Minimum thermostat sensor											
If the temperature of the heating battery sensor at power-on is between ζ_{15} and $\zeta_{15} - 2$, the minimum thermostat is considered open.											
$I_{13}=4$ Remote contact for season changeover	$I_{14} =$	<table border="1"> <thead> <tr> <th></th> <th>0</th> <th>1</th> </tr> </thead> <tbody> <tr> <td>Summer</td> <td></td> <td></td> </tr> <tr> <td>Winter</td> <td></td> <td></td> </tr> </tbody> </table>		0	1	Summer			Winter		
	0	1									
Summer											
Winter											
$I_{13}=5$ Remote On/Off (Do not use if a supervisor system is connected to master unit. Supervisor has higher priority and contact is not considered on this case)	$I_{14} =$	<table border="1"> <thead> <tr> <th></th> <th>0</th> <th>1</th> </tr> </thead> <tbody> <tr> <td>Off</td> <td></td> <td></td> </tr> <tr> <td>On</td> <td></td> <td></td> </tr> </tbody> </table>		0	1	Off			On		
	0	1									
Off											
On											
$I_{13}=6$ Unoccupied holidays	$I_{14} =$	<table border="1"> <thead> <tr> <th></th> <th>0</th> <th>1</th> </tr> </thead> <tbody> <tr> <td>"Unoccupied holidays" mode</td> <td></td> <td></td> </tr> <tr> <td>Occupied mode</td> <td></td> <td></td> </tr> </tbody> </table>		0	1	"Unoccupied holidays" mode			Occupied mode		
	0	1									
"Unoccupied holidays" mode											
Occupied mode											
$I_{13}=7$ Energy saving	$I_{14} =$	<table border="1"> <thead> <tr> <th></th> <th>0</th> <th>1</th> </tr> </thead> <tbody> <tr> <td>No economy mode</td> <td></td> <td></td> </tr> <tr> <td>Economy mode</td> <td></td> <td></td> </tr> </tbody> </table>		0	1	No economy mode			Economy mode		
	0	1									
No economy mode											
Economy mode											
$I_{13}=8$ Window contact	$I_{14} =$	<table border="1"> <thead> <tr> <th></th> <th>0</th> <th>1</th> </tr> </thead> <tbody> <tr> <td>Window open</td> <td></td> <td></td> </tr> <tr> <td>Window closed</td> <td></td> <td></td> </tr> </tbody> </table>		0	1	Window open			Window closed		
	0	1									
Window open											
Window closed											
$I_{13}=9$ Alarm	$I_{14} =$	<table border="1"> <thead> <tr> <th></th> <th>0</th> <th>1</th> </tr> </thead> <tbody> <tr> <td>Alarm absent</td> <td></td> <td></td> </tr> <tr> <td>Alarm present</td> <td></td> <td></td> </tr> </tbody> </table>		0	1	Alarm absent			Alarm present		
	0	1									
Alarm absent											
Alarm present											
$I_{13}=10$ Remote setpoint variator input	The setpoint variator SAP-NTC-02-2-EV must be connected in order to change the slave setpoint										

For $I_{13}=4$ to 9 configurations, analogue input 2 is used as a digital input. The contact is considered closed, if there is a short circuit on the analogue input. The contact is considered open, if nothing is connected.

Setting is done either by setting parameters on the optional THS2 connected to master unit or by modbus of master unit and writing the following variables:

ADR_MOD_ANAINPUT2FUN (11081) for setting I_{13}

ADR_MOD_ANAINPUT2LOG (11082) for setting I_{14}

The digital inputs or analogue inputs that are common to all network such as remote on/off, change-over season, economy, unoccupied holidays, window contact must be connected to the master unit in order to be visible by the whole internal network. On the example below are indicated the connection of digital inputs that are common to the whole internal network:

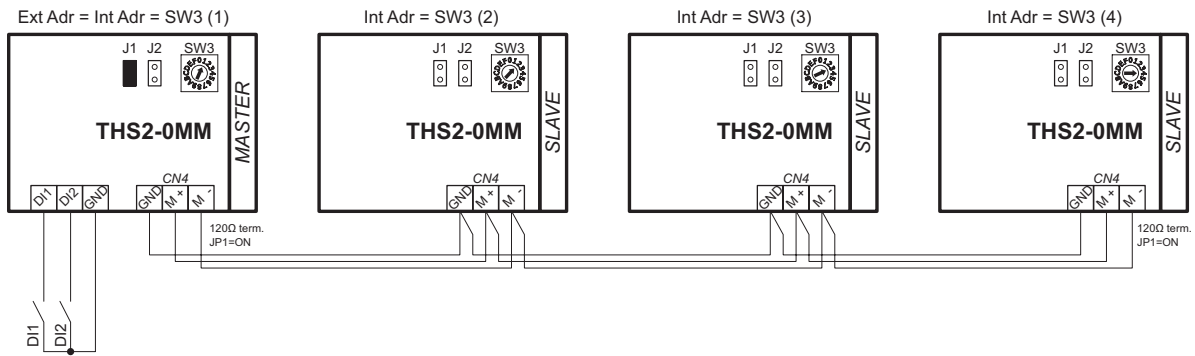

If no master is present each unit works independently, it is necessary to connect a digital input or an analogue input, that is configured for a function, on each unit.

The digital contacts or analogue inputs that are local to each unit such as minimum thermostat or alarm contact must be connected to each unit. On the example below are indicated the connection of digital inputs that are not common to the whole internal network:

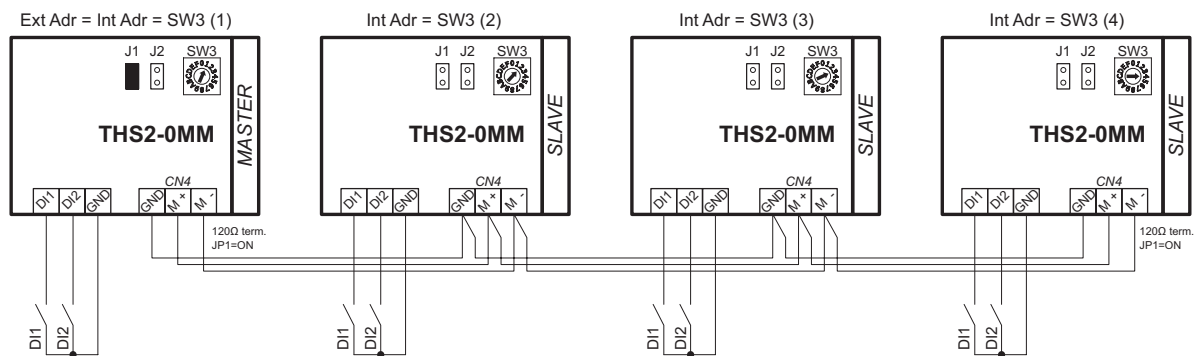

Note:

If the same function is assigned to the digital and/or analogue inputs on the master and slaves and also on an optional THS2 connected to the master unit, the following priority applies in cases of similar assignment:

Priority of inputs for remote season changeover, on/off, unoccupied holidays, economy, window contact:

- THS2 digital input 1 (**DI1**) - Highest priority↓
- THS2 digital input 2 (**DI2**)
- THS2-0MM digital input 1 (**DI1**)
- THS2-0MM digital input 2 (**DI2**)
- THS2-0MM analogue input 1 (**AI1**)
- THS2-0MM analogue input 2 (**AI2**) - Lowest priority

Priority of inputs for minimum thermostat function for each slave:

- THS2 digital input 1 (**DI1**) - Highest priority↓
- THS2 digital input 2 (**DI2**)
- THS2-0MM digital input 1 (**DI1**)
- THS2-0MM digital input 2 (**DI2**)
- THS2-0MM analogue input 1 (**AI1**)
- THS2-0MM analogue input 2 (**AI2**) - Lowest priority

In case of alarm function there is no priority, it is possible to have several independent alarm contacts for master and each slave.

9. Automatic season changeover with water sensor

In 2-pipe systems ($I 1=0$), if no digital input is configured for remote season changeover, and no analogue input is configured as a remote season changeover contact, it is possible to use a remote sensor of the THS2-0MM master unit for the internal network and configure it as a water sensor for automatic season changeover ($I 1=2$ or $I 13=2$).

The example below indicates the automatic change-over season sensor based on AI2 of master unit:

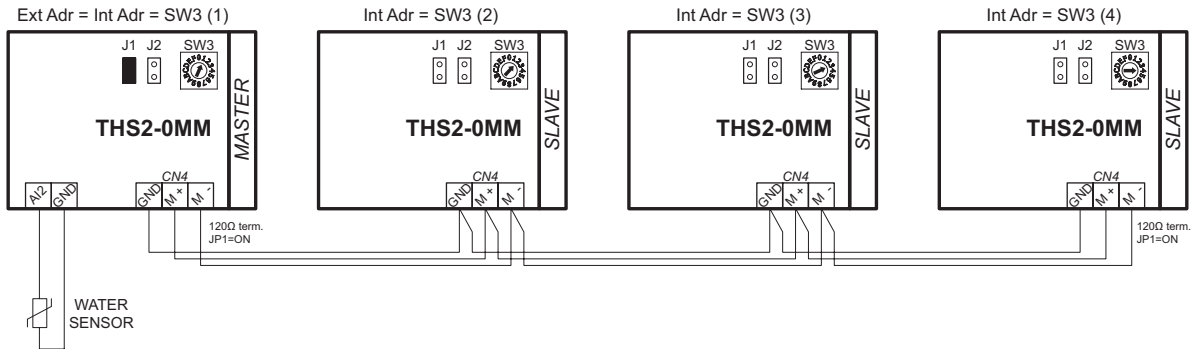

Write 2 on variable `ADR_MOD_ANAINPUT2FUN` (11081) (parameter $I 13$).

The season changeover is implemented automatically according to the water temperature at the inlet of the fan coil unit. Depending on the value of parameter $\epsilon 15$, the season changeover takes place as follows:

$\epsilon 15=0$ or 1:

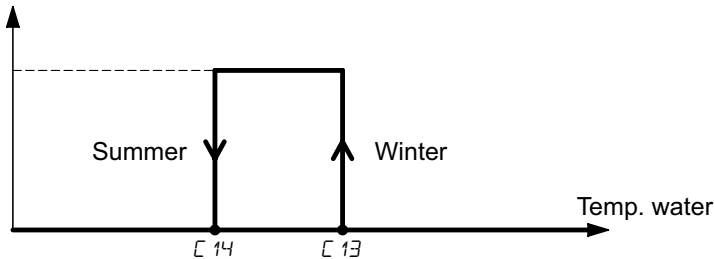

$\epsilon 13$: heating setpoint for automatic season changeover sensor

$\epsilon 14$: cooling setpoint for automatic season changeover sensor

When the unit is switched on, if the water sensor temperature is between $\epsilon 14$ and $\epsilon 13$, the operating season is heating (if $\epsilon 15=0$) or cooling (if $\epsilon 15=1$). Then, if the temperature of the water sensor varies and exceeds $\epsilon 13$, heating becomes the operating season. If the temperature of the water sensor varies and falls below $\epsilon 14$, cooling becomes the operating season.

$\epsilon 15=2$:

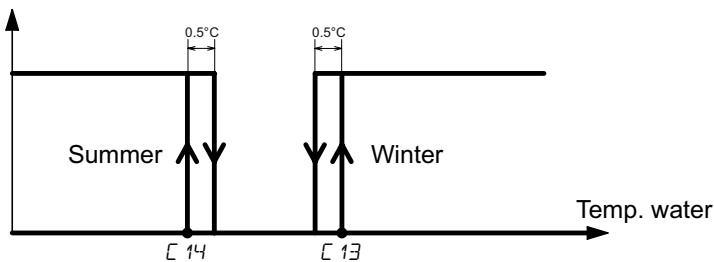

$\epsilon 13$: heating setpoint for automatic season changeover sensor

$\epsilon 14$: cooling setpoint for automatic season changeover sensor

When the unit is switched on, if the water sensor temperature is between $\epsilon 14$ and $\epsilon 13$, the operating season is not specified, and there is no regulation. Then, if the temperature of the water sensor varies and exceeds $\epsilon 13$, heating becomes the operating season. If it falls below $\epsilon 13 - 0.5^\circ\text{C}$ again, the season is unspecified, and regulation is stopped. If the temperature of the water sensor varies and falls below $\epsilon 14$, cooling becomes the operating season. If it rises above $\epsilon 14 + 0.5^\circ\text{C}$ again, the season is unspecified, and regulation is stopped.

Setting of parameters $\epsilon 13$, $\epsilon 14$, $\epsilon 15$ is done either by setting parameters on the optional THS2 connected to master unit or by modbus via connector CN2 of master unit and writing the following registers:

`ADR_MOD_WINTERSETCO` (11134) for setting $\epsilon 13$

10. Working setpoint, economy and unoccupied holidays mode

If one of the digital contacts is configured as a remote "unoccupied holidays" contact $M01=3$ (D11) or $M03=3$ (D12) on the optional THS2, or if one of the digital contacts is configured as a remote "unoccupied holidays" contact $I07=3$ (D11) or $I09=3$ (D12), or an analogue input is configured as an "unoccupied holidays" contact $I11=6$ (AI1) or $I13=6$ (AI2) on a THS2-0MM master, the "unoccupied holidays" function can be activated, if the corresponding contact is in the appropriate position (see "8. Logic of digital and analogue inputs THS2-0MM" page 16 and "43. Logic of digital inputs THS2" page 77).

2-pipe systems ($I01=0$):

In "unoccupied holidays" mode, the working heating setpoint is decreased by $\llbracket 09$ (see 2-pipe heating diagram, WHS), the working cooling setpoint is increased by $\llbracket 09$ (see 2-pipe cooling diagram, WCS).

4-pipe systems ($I01=1$):

In "unoccupied holidays" mode, the heating trigger point is decreased by $\llbracket 09$ (see 4-pipe diagram, WHS), and the cooling trigger point is increased by $\llbracket 09$ (see 4-pipe diagram, WCS).

In case of presence of optional THS2 connected to a THS2-0MM, the  icon lights up to indicate "unoccupied holidays" mode.

If one of the digital contacts is configured as a remote "energy saving" contact $M01=4$ (D11) or $M03=4$ (D12) on the optional THS2, or if one of the digital contacts is configured as a remote "energy saving" contact $I07=4$ (D11) or $I09=4$ (D12), or an analogue input is configured as an "energy saving" contact $I11=7$ (AI1) or $I13=7$ (AI3) on a THS2-0MM master, the energy-saving function can be activated, if the corresponding contact is in the appropriate position (see "8. Logic of digital and analogue inputs THS2-0MM" page 16 and "43. Logic of digital inputs THS2" page 77).

2-pipe systems ($I01=0$):

The working heating setpoint is decreased by $\llbracket 08$ (see 2-pipe heating diagram, WHS), and the working cooling setpoint is increased by $\llbracket 08$ (see 2-pipe cooling diagram, WCS).

4-pipe systems ($I01=1$):

In "energy saving" mode, the heating trigger point is decreased by $\llbracket 08$ (see 4-pipe diagram, WHS), and the cooling trigger point is increased by $\llbracket 08$ (see 4-pipe diagram, WCS).

In case of presence of optional THS2 connected to a THS2-0MM, the "ECO" icon is turned on to indicate "energy saving" mode.

The "unoccupied holidays" mode has priority over economy mode when both functions are triggered.

2-pipe diagram (analogue output, cooling)

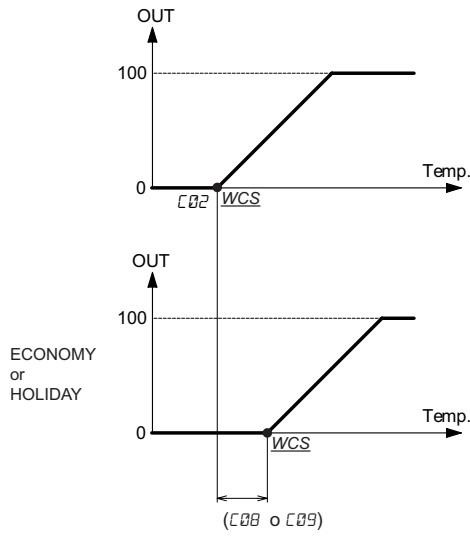

$CB2$ 2-pipe cooling setpoint
WCS: cooling trigger point

2-pipe diagram (digital output, cooling)

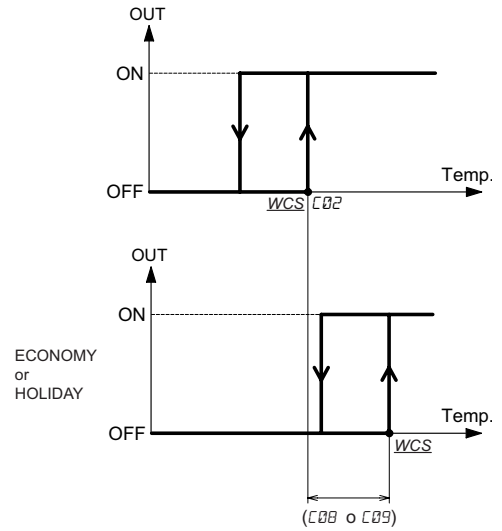

$CB2$ 2-pipe cooling setpoint
WCS: cooling trigger point

2-pipe diagram (analogue output, heating)

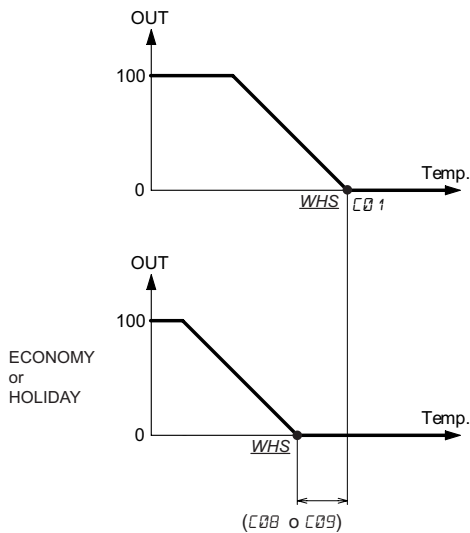

$CB1$: 2-pipe heating setpoint
WHS: heating trigger point

2-pipe diagram (digital output, heating)

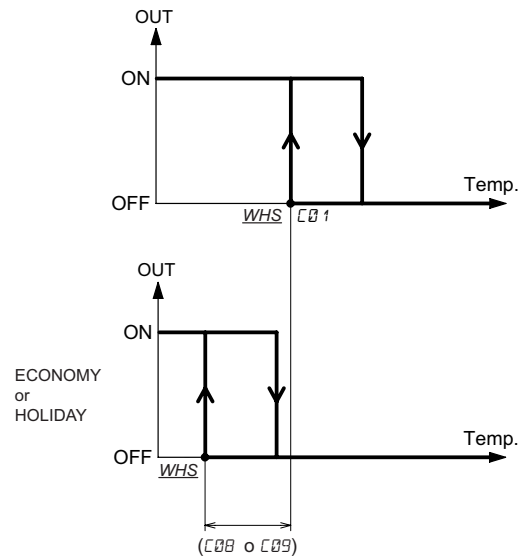

$CB1$: 2-pipe heating setpoint
WHS: heating trigger point

4-pipe diagram (analogue output)

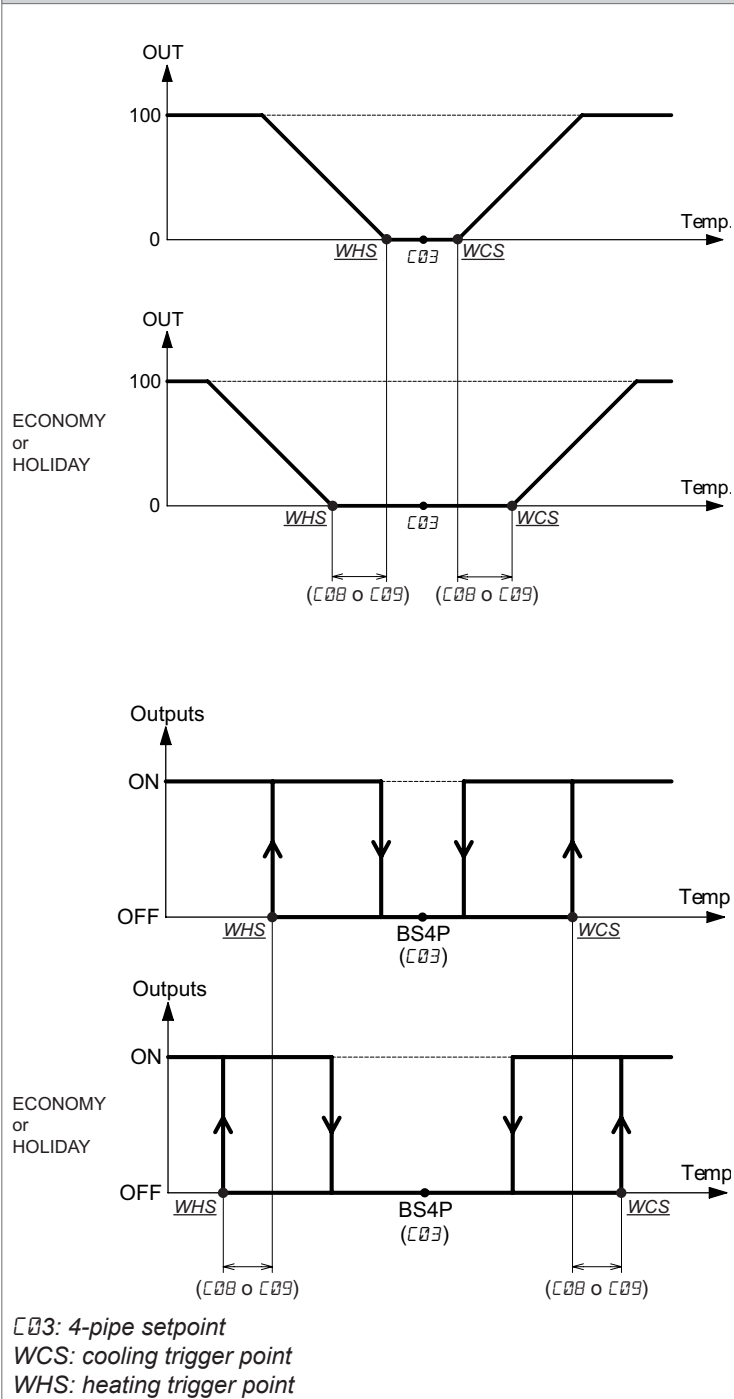

It is possible to display the working setpoint with an optional THS2 connected to a THS2-0MM in the I/O status menu (see paragraph [“44. Input/output status of THS2-0MM connected to THS2” page 77](#)). In this case, the value corresponding to *WHS* in the "WHS" submenu is displayed in heating mode, and the value corresponding to the *WCS* in the "WCS" submenu is displayed in cooling mode.

If none of the contacts are configured in "unoccupied holidays" or "energy saving" mode, by an optional THS2 connected to THS2-0MM master it is possible to program time bands in order to regulate with base setpoints within the time bands and in economy mode outside. To do so set $Mod=L, Mb$ on THS2, and the time band function $M1B=0$ (see [“33. Setting parameters using quick access on THS2” page 54](#)).

If this is not the case, the status of the contact configured in "unoccupied holidays" or "energy saving" mode takes priority, and the time bands are not taken into account.

If none of the contacts are configured in "unoccupied holidays" or "energy saving" mode, regulation takes place in unoccupied holidays if the operating mode is unoccupied holidays mode (set manually via quick access parameters → see [“MODE key function” page 56](#)). If this is not the case, the status of the contact configured in "unoccupied holidays" or "energy saving" mode overrides the manual setting.

When the timer extension function is activated manually on THS2 connected to the THS2-0MM master it has higher priority than energy saving, unoccupied holidays and time band modes (see [“34. Timer extension or forced presence mode” page 58](#)).

11. Temperature regulation batteries

The temperature regulation batteries are configured via the parameters

- heating battery (stage 1) *I03*, variable **ADR_MOD_TYPHEATINGCOIL** (11071)
- cooling battery *I04*, variable **ADR_MOD_TYPCOOLINGCOIL** (11072)
- supplemental battery (stage 2 heating or for mid-season operation) *I05*, variable **ADR_MOD_TYPADDCOIL** (11073).

Battery	Battery type	Setting
Heating battery	No heating battery	<i>I03</i> =0
	Modulating electrical resistance	<i>I03</i> =1
	Modulating heating valve	<i>I03</i> =2
	On/off electrical resistance	<i>I03</i> =3
	On/off heating valve	<i>I03</i> =4
Cooling battery	No cooling battery	<i>I04</i> =0
	Modulating cooling valve	<i>I04</i> =1
	Cooling valve on/off	<i>I04</i> =2
Hot/cold mixed-use battery	No mixed-use battery	-
	Modulating mixed-use valve	<i>I03</i> =2 and <i>I04</i> =1
	Mixed-use on/off valve	<i>I03</i> =4 and <i>I04</i> =2
Supplemental heating battery	No supplemental heating battery	<i>I05</i> =0
	Supplemental heating battery on/off	<i>I05</i> =1
	Modulating supplemental heating battery	<i>I05</i> =2

Set the outputs to activate the selected batteries as shown in the table below:

- output DO1 *I15*, variable **ADR_MOD_DIGOUTPUT1FUNC** (11083)
- output DO2 *I16*, variable **ADR_MOD_DIGOUTPUT2FUNC** (11084)
- output DO3 *I17*, variable **ADR_MOD_DIGOUTPUT3FUNC** (11085)
- output DO4 *I18*, variable **ADR_MOD_DIGOUTPUT4FUNC** (11086)
- output DO5 *I19*, variable **ADR_MOD_DIGOUTPUT5FUNC** (11087)
- output DO6 *I20*, variable **ADR_MOD_DIGOUTPUT6FUNC** (11088)
- output AO1 *I21*, variable **ADR_MOD_ANAOUTPUT1FUNC** (11089)
- output AO2 *I22*, variable **ADR_MOD_ANAOUTPUT2FUNC** (11090)
- output AO3 *I23*, variable **ADR_MOD_ANAOUTPUT3FUNC** (11091).

Element	Setting
Modulating electrical resistance	<i>I21</i> =8 (AO1) or <i>I22</i> =8 (AO2) or <i>I23</i> =8 (AO3)
Modulating heating valve	<i>I21</i> =2 (AO1) or <i>I22</i> =2 (AO2) or <i>I23</i> =2 (AO3)
On/off electrical resistance	<i>I15</i> =7 (DO1) or <i>I16</i> =7 (DO2) or <i>I17</i> =7 (DO3) or <i>I18</i> =7 (DO4) or <i>I19</i> =7 (DO5) or <i>I20</i> =7 (DO6)
On/off heating valve	<i>I15</i> =4 (DO1) or <i>I16</i> =4 (DO2) or <i>I17</i> =4 (DO3) or <i>I18</i> =4 (DO4) or <i>I19</i> =4 (DO5) or <i>I20</i> =4 (DO6)
Modulating cooling valve	<i>I21</i> =3 (AO1) or <i>I22</i> =3 (AO2) or <i>I23</i> =3 (AO3)

Cooling valve on/off	<i>I 15=5 (DO1) or I 16=5 (DO2) or I 17=5 (DO3) or I 18=5 (DO4) or I 19=5 (DO5) or I 20=5 (DO6)</i>
Modulating mixed-use valve	<i>I 21=4 (AO1) or I 22=4 (AO2) or I 23=4 (AO3)</i>
Mixed-use on/off valve	<i>I 15=6 (DO1) or I 16=6 (DO2) or I 17=6 (DO3) or I 18=6 (DO4) or I 19=6 (DO5) or I 20=6 (DO6)</i>
Supplemental modulating resistance	<i>I 21=9 (AO1) or I 22=9 (AO2) or I 23=9 (AO3)</i>
Supplemental on/off resistance	<i>I 15=8 (DO1) or I 16=8 (DO2) or I 17=8 (DO3) or I 18=8 (DO4) or I 19=8 (DO5) or I 20=8 (DO6)</i>
3-point (open) on/off heating valve	<i>I 15=15 (DO1) or I 16=15 (DO2) or I 17=15 (DO3) or I 19=15 (DO5) or I 20=15 (DO6)</i>
3-point (close) on/off heating valve	<i>I 15=16 (DO1) or I 16=16 (DO2) or I 17=16 (DO3) or I 19=16 (DO5) or I 20=16 (DO6)</i>
3-point (open) cooling valve on/off	<i>I 15=17 (DO1) or I 16=17 (DO2) or I 17=17 (DO3) or I 19=17 (DO5) or I 20=17 (DO6)</i>
3-point (close) cooling valve on/off	<i>I 15=18 (DO1) or I 16=18 (DO2) or I 17=18 (DO3) or I 19=18 (DO5) or I 20=18 (DO6)</i>
3-point (open) mixed-use valve on/off	<i>I 15=19 (DO1) or I 16=19 (DO2) or I 17=19 (DO3) or I 19=19 (DO5) or I 20=19 (DO6)</i>
3-point (close) mixed-use valve on/off	<i>I 15=20 (DO1) or I 16=20 (DO2) or I 17=20 (DO3) or I 19=20 (DO5) or I 20=20 (DO6)</i>

12. Heating and cooling battery logic

The operating logic of the heating and cooling batteries depends on the following parameters:

- $I01$: type of regulation chosen, variable **ADR_MOD_TYPEREG** (11069)
- $I03$: type of heating battery (stage 1), variable **ADR_MOD_TYPHEATINGCOIL** (11071)
- $I04$: type of cooling battery, variable **ADR_MOD_TYPCOOLINGCOIL** (11072)

• 2-pipe HEATING regulation ($I01=0$)

The "HEAT" icon is lit to indicate the heating function.

Modulating regulation:

- PI-type regulation operates as follows for modulating regulation:

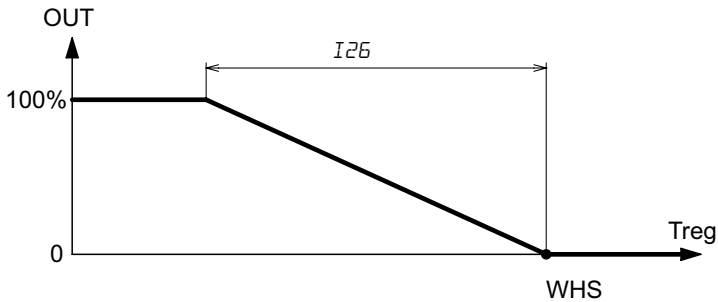



Treg: regulation sensor

WHS: calculated heating setpoint



OUT: modulated output:

- modulating valve if $I03=2$ and $I21=2$ (AO1) or $I22=2$ (AO2) or $I23=2$ (AO3)
- modulating electrical resistance if $I03=1$ and $I21=8$ (AO1) or $I22=8$ (AO2) or $I23=8$ (AO3)
- modulating mixed-use valve if $I03=2$ and $I04=1$ and $I21=4$ (AO1) or $I22=4$ (AO2) or $I23=4$ (AO3)

$I27$: proportional heating band

If the operating temperature drops below the *WHS*, the valve begins to open, or the modulating electrical resistance begins to be modulated. The  icon lights up, if a valve is being controlled; the  icon lights up for the modulating resistance.

The valve or modulating resistance can be regulated with PI action, if the integral heating time $I28$ does not equal 0, or with proportional action only, if $I28=0$.

The  (or ) icon turns off, if the modulating valve closes or the electrical resistance is interrupted (no longer powered).

Note: the icons indicated are present on an optional THS2 connected to the THS2-0MM.

On/off regulation:

- On/off-type regulation operates as follows:

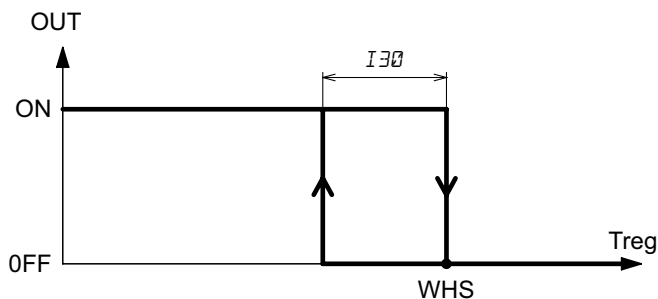





Treg: regulation sensor

WHS=calculated heating setpoint

OUT: on/off output:

- on/off valve if $I03=4$ and $I15=4$ (DO1) or $I16=4$ (DO2) or $I17=4$ (DO3) or $I18=4$ (DO4) or $I19=4$ (DO5) or $I20=4$ (DO6)
- on/off electrical resistance, if $I03=3$ and $I15=7$ (DO1) or $I16=7$ (DO2) or $I17=7$ (DO3) or $I18=7$ (DO4) or $I19=7$ (DO5) or $I20=7$ (DO6)
- mixed-use valve on/off if $I03=4$, $I04=2$, $I15=6$ (DO1) or $I16=6$ (DO2) or $I17=6$ (DO3) or $I18=6$ (DO4) or $I19=6$ (DO5) or $I20=6$ (DO6)

$I31$: hysteresis for on/off heating output

If $T_{reg} < (WHS - I_{31})$ the valve (or electrical resistance) is activated. The  (or ) icon lights up.
 If $T_{reg} \geq WHS$, the valve (or electrical resistance) is deactivated. The  (or ) icon turns off.
 Note: the icons indicated are present on an optional THS2 connected to the THS2-0MM.

• **2-pipe COOLING regulation ($I_{10} \neq 0$) without mid-season changeover ($M_{13} = 0$)**

The "COOL" icon lights up to indicate the cooling function.

Modulating regulation:

- PI-type regulation operates as follows for modulating regulation:

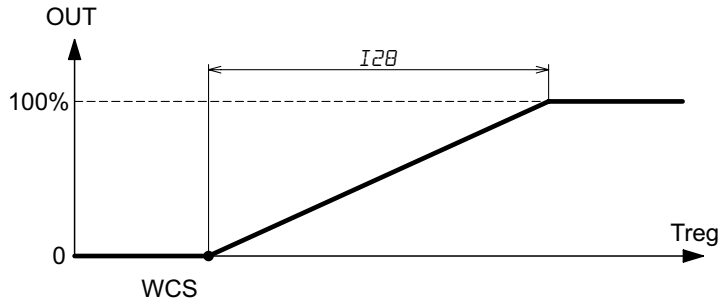

Treg: regulation sensor

WCS: calculated cooling setpoint

OUT: modulated output:

- modulating valve if $I_{104} = 1$ and $I_{121} = 3$ (AO1) or $I_{122} = 3$ (AO2) or $I_{123} = 3$ (AO3)

- modulating mixed-use valve if $I_{103} = 2$ and $I_{104} = 1$ and $I_{121} = 4$ (AO1) or $I_{122} = 4$ (AO2) or $I_{123} = 4$ (AO3)

I28: proportional cooling band

If the operating temperature rises above the WCS, the modulating valve begins to open. The  icon lights up.

The valve can be regulated with PI action, if the cooling integral time I_{30} does not equal 0, or with proportional action only, if $I_{30} = 0$.

The  icon turns off, if the valve closes.

Note: the icons indicated are present on an optional THS2 connected to the THS2-0MM.

On/off regulation:

- On/off-type regulation operates as follows:

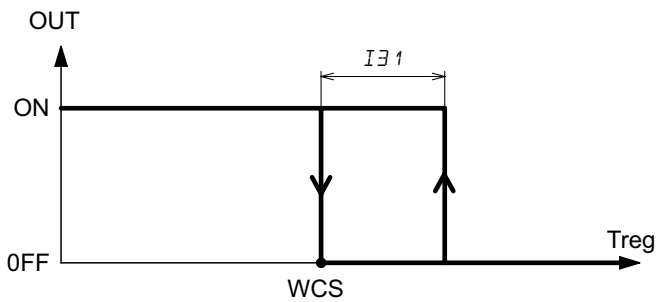

Treg: regulation sensor

WCS: calculated cooling setpoint

OUT: on/off output:

- on/off valve if $I_{104} = 2$ and $I_{115} = 5$ (DO1) or $I_{116} = 5$ (DO2) or $I_{117} = 5$ (DO3) or $I_{118} = 5$ (DO4) or $I_{119} = 5$ (DO5) or $I_{120} = 5$ (DO6)

- mixed-use valve on/off if $I_{103} = 4$, $I_{104} = 2$, $I_{115} = 6$ (DO1) or $I_{116} = 6$ (DO2) or $I_{117} = 6$ (DO3) or $I_{118} = 6$ (DO4) or $I_{119} = 6$ (DO5) or $I_{120} = 6$ (DO6)

I31: hysteresis for on/off cooling output

If $T_{reg} > (WCS + I_{32})$, the valve is activated. The  icon lights up.

If $T_{reg} \leq WCS$, the valve is deactivated, and the icon  turns off.

Note: the icons indicated are present on an optional THS2 connected to the THS2-0MM.

• **2-pipe COOLING regulation ($I_{10}=0$) with mid-season changeover ($M_{13}=1$)**

The "COOL" icon lights up to indicate the cooling function.

Mid-season operation allows heating via an electrical resistance that can be modulating or on/off in event of a sudden drop in temperature during the summer.

Mid-season operation with modulating electrical resistance:

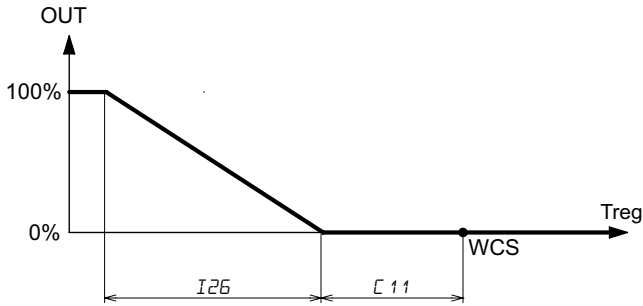

Treg: regulation sensor

WCS: calculated cooling setpoint

I11: heating insertion differential during summer

I27: proportional heating band

OUT: supplemental modulating electrical resistance if $I_{05}=2$ and $I_{21}=9$ (AO1) or $I_{22}=9$ (AO2) or $I_{23}=9$ (AO3)

If $Treg < WCS - I11$, the supplemental modulating electrical resistance begins to be activated, and the  icon lights up and remains on until the temperature rises above this threshold.

The supplemental modulating resistance can be regulated with PI action, if the integral heating time I_{28} does not equal 0, or with proportional action only, if $I_{28}=0$.

Note: the icons indicated are present on an optional THS2 connected to the THS2-0MM.

Mid-season operation with on/off electrical resistance:

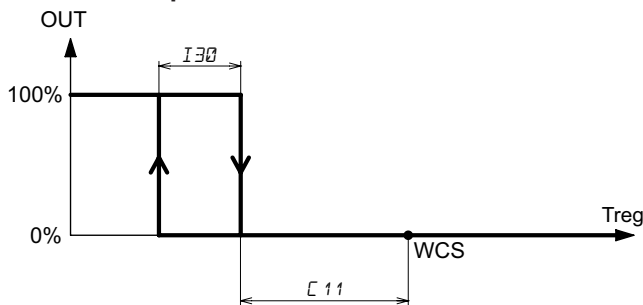

Treg: regulation sensor

WCS: calculated cooling setpoint

I11: heating insertion differential during summer

I31: hysteresis for on/off heating output

OUT: supplemental on/off electrical resistance, if $I_{05}=1$ and $I_{15}=8$ (DO1) or $I_{16}=8$ (DO2) or $I_{17}=8$ (DO3) or $I_{18}=8$ (DO4) or $I_{19}=8$ (DO5) or $I_{20}=8$ (DO6)

If $Treg < (WCS - I11 - I31)$, the supplemental electrical resistance is activated. The  icon lights up.

If $Treg \geq (WCS - I11)$, the supplemental electrical resistance is deactivated, and the  icon turns off.

Note: the icons indicated are present on an optional THS2 connected to the THS2-0MM.

• 4-pipe regulation (I01=1)

In 4-pipe mode, the operating season is automatically selected according to the regulation temperature, the 4-pipe room setpoint ΔT and the neutral zone ΔT .

Depending on the regulation selected, two setpoints are calculated:

- WHS: heating setpoint= $\Delta T - (\Delta T/2)$
- WCS: cooling setpoint= $\Delta T + (\Delta T/2)$

If the temperature rises above the WCS, the operating season is considered to be cooling, and the “COOL” icon lights up. If the temperature drops below the WHS, the operating season is considered to be heating, and the “HEAT” icon lights up.

Note: the icons indicated are present on an optional THS2 connected to the THS2-0MM.

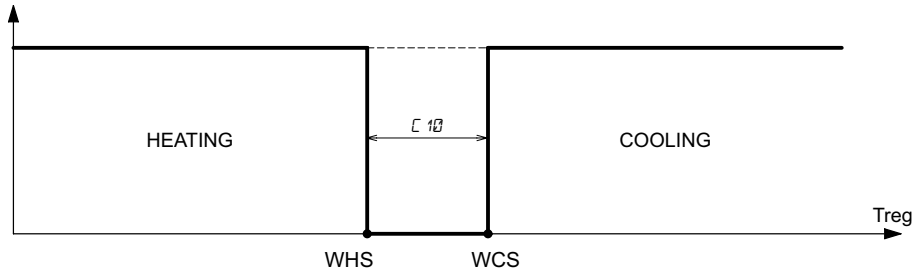

Treg: regulation sensor

WHS: calculated heating setpoint

WCS: calculated cooling setpoint

ΔT : neutral zone

Note: when the unit is switched on, if the Treg temperature is in the neutral zone, the season is considered heating. The mid-season activation parameter M13 has no influence on 4-pipe regulation and is not taken into account.

Modulating heating and cooling regulation:

- PI-type regulation operates as follows for modulating regulation:

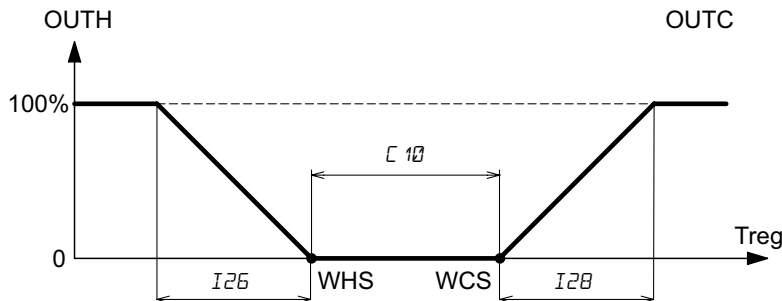

Treg: regulation sensor

WHS: calculated heating setpoint

WCS: calculated cooling setpoint

ΔT : neutral zone

I27: proportional heating band



I29: proportional cooling band



OUTH: heating modulating output:

- modulating valve if I03=2 and I21=2 (AO1) or I22=2 (AO2) or I23=2 (AO3)
- modulating electrical resistance if I03=1 and I21=8 (AO1) or I22=8 (AO2) or I23=8 (AO3)

OUTC: cooling modulating output:

- modulating valve if I04=1 and I21=3 (AO1) or I22=3 (AO2) or I23=3 (AO3)

If the operating temperature drops below the WHS, the heating valve begins to open, or the modulating electrical resistance begins to be modulated. The  icon lights up, if a valve is being controlled; the  icon lights up for the modulating resistance. The valve or modulating resistance can be regulated with PI action, if the integral heating time I28 does not equal 0, or with proportional action only, if I28=0.

The  (or ) icon turns off, if the modulating heating valve closes or the electrical resistance is turned off (no longer powered) when $Treg \geq WHS$.

If the operating temperature rises above the WCS, the modulating cooling valve begins to open. The  icon lights up.

The valve can be regulated with PI action, if the integral time $I30$ does not equal 0, or with proportional action only, if $I30=0$. The ❄️ icon turns off, if the valve closes when $Treg \leq WCS$.

Note: the icons indicated are present on an optional THS2 connected to the THS2-0MM.

Modulating heating regulation and on/off cooling:

- PI-type regulation operates as follows for modulating regulation:

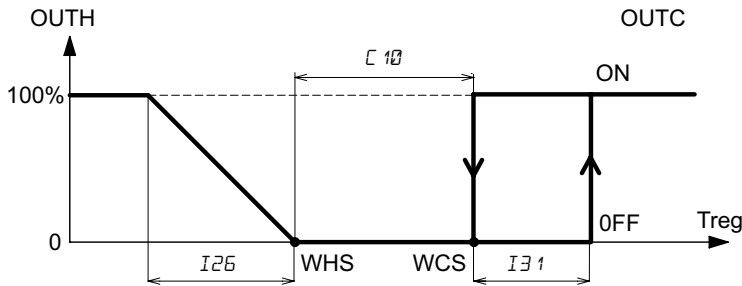

$Treg$: regulation sensor

WHS : calculated heating setpoint

WCS : calculated cooling setpoint

$I10$: neutral zone

$I32$: hysteresis for on/off cooling output

$I27$: proportional heating band

$OUTH$: heating modulating output:

- modulating valve if $I03=2$ and $I21=2$ (AO1) or $I22=2$ (AO2) or $I23=2$ (AO3)

- modulating electrical resistance if $I03=1$ and $I21=8$ (AO1) or $I22=8$ (AO2) or $I23=8$ (AO3)

$OUTC$: on/off cooling output:

- on/off valve if $I04=2$ and $I15=5$ (DO1) or $I16=5$ (DO2) or $I17=5$ (DO3) or $I18=5$ (DO4) or $I19=5$ (DO5) or

$I20=5$ (DO6)

If the operating temperature drops below the WHS , the heating valve begins to open, or the modulating electrical resistance begins to be modulated. The icon lights up, if a valve is being controlled; the icon lights up for the modulating electrical resistance.

The valve or modulating resistance can be regulated with PI action, if the integral heating time $I28$ does not equal 0, or with proportional action only, if $I28=0$.

The (or) icon turns off, if the modulating heating valve closes or the electrical resistance is turned off (no longer powered) when $Treg \geq WHS$.

If $Treg > (WCS + I32)$, the cooling valve is activated. The ❄️ icon lights up.

If $Treg \leq WCS$ the cooling valve is deactivated, and the ❄️ icon turns off.

Note: the icons indicated are present on an optional THS2 connected to the THS2-0MM.

On/off heating and cooling regulation:

- PI-type regulation operates as follows for modulating regulation:

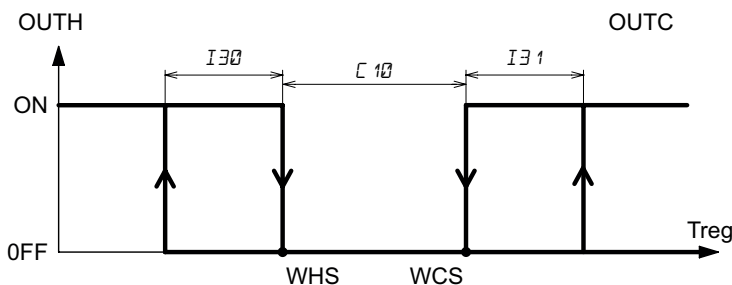

$Treg$: regulation sensor

WHS : calculated heating setpoint

WCS : calculated cooling setpoint

$I10$: neutral zone

$I31$: hysteresis for on/off heating output

$I32$: hysteresis for on/off cooling output

$OUTH$: on/off heating output:



- on/off valve if $I03=4$ and $I15=4$ (DO1) or $I16=4$ (DO2) or $I17=4$ (DO3) or $I18=4$ (DO4) or $I19=4$ (DO5) or

$I20=4$ (DO6)

- on/off electrical resistance, if $I_{03}=3$ and $I_{15}=7$ (DO1) or $I_{16}=7$ (DO2) or $I_{17}=7$ (DO3) or $I_{18}=7$ (DO4) or $I_{19}=7$ (DO5) or $I_{20}=7$ (DO6)

OUTC: on/off cooling output:

- on/off valve if $I_{04}=2$ and $I_{15}=5$ (DO1) or $I_{16}=5$ (DO2) or $I_{17}=5$ (DO3) or $I_{18}=5$ (DO4) or $I_{19}=5$ (DO5) or $I_{20}=5$ (DO6)

If $T_{reg} < (WHS - I_{31})$, the heating valve (or electrical resistance) is activated. The  (or ) icon lights up.

If $T_{reg} \geq WHS$, the heating valve (or electrical resistance) is deactivated. The  (or ) icon turns off.

If $T_{reg} > (WCS + I_{29})$, the cooling valve is activated. The  icon lights up.

If $T_{reg} \leq WCS$ the cooling valve is deactivated, and the  icon turns off.

Note: the icons indicated are present on an optional THS2 connected to the THS2-0MM.

On/off heating and modulating cooling regulation:

- PI-type regulation operates as follows for modulating regulation:

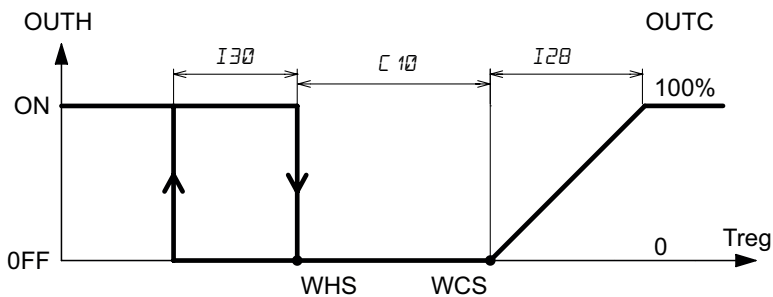

T_{reg} : regulation sensor

WHS : calculated heating setpoint

WCS : calculated cooling setpoint

I_{10} : neutral zone

I_{31} : hysteresis for on/off heating output

I_{29} : proportional cooling band



OUTH: on/off heating output:

- on/off valve if $I_{03}=4$ and $I_{15}=4$ (DO1) or $I_{16}=4$ (DO2) or $I_{17}=4$ (DO3) or $I_{18}=4$ (DO4) or $I_{19}=4$ (DO5) or $I_{20}=4$ (DO6)

- on/off electrical resistance, if $I_{03}=3$ and $I_{15}=7$ (DO1) or $I_{16}=7$ (DO2) or $I_{17}=7$ (DO3) or $I_{18}=7$ (DO4) or $I_{19}=7$ (DO5) or $I_{20}=7$ (DO6)

OUTC: modulating output:

- modulating valve if $I_{04}=1$ and $I_{21}=3$ (AO1) or $I_{22}=3$ (AO2) or $I_{23}=3$ (AO3)

If $T_{reg} < (WHS - I_{31})$, the heating valve (or electrical resistance) is activated. The  (or ) icon lights up.

If $T_{reg} \geq WHS$, the heating valve (or electrical resistance) is deactivated. The  (or ) icon turns off.

If the operating temperature rises above the WCS , the modulating cooling valve begins to open. The  icon lights up.

The cooling valve can be regulated with PI action, if the integral time I_{30} does not equal 0, or with proportional action only, if $I_{30}=0$.

The  icon turns off, if the cooling valve closes.

Note: the icons indicated are present on an optional THS2 connected to the THS2-0MM.

13. 3-point valve

A slave is capable of controlling 3-point valves for 2-pipe or 4-pipe systems.

• 3-point, 2-pipe HEATING regulation ($I\bar{0}1=0$)

The "HEAT" icon is lit to indicate the heating function.

Define the following settings to use a 3-point heating valve:

- Select digital output for controlling the opening of the 3-point on/off heating valve $I\bar{0}3=4$ and $I\ 15=15$ (DO1) or $I\ 16=15$ (DO2) or $I\ 17=15$ (DO3) or $I\ 19=15$ (DO5) or $I\ 20=15$ (DO6),
- Select digital output for controlling the closure of the 3-point on/off heating valve $I\ 15=16$ (DO1) or $I\ 16=16$ (DO2) or $I\ 17=16$ (DO3) or $I\ 19=16$ (DO5) or $I\ 20=16$ (DO6),
- Set the valve stroke time with parameter $I\ 52$.

The PI-type regulation in heating mode takes place as follows for 3-point on/off regulation:

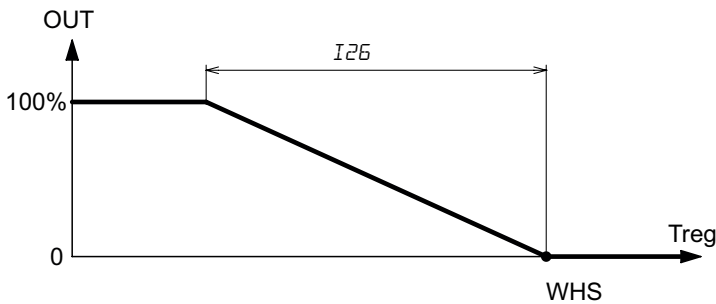

Treg: regulation sensor

WHS: calculated heating setpoint

OUT: 3-point on/off heating output

$I\ 27$: proportional heating band

If the operating temperature drops below the *WHS*, the valve begins to open. The  icon lights up.

The on/off 3-point valve can be regulated with PI action, if the integral heating time $I\ 28$ does not equal 0, or with proportional action only, if $I\ 28=0$.

The  icon turns off, if the 3-point valve closes.

Note: the icons indicated are present on an optional THS2 connected to the THS2-0MM.

When the controller is switched on, the valve runs through a reset cycle (valve closure) for 120% of the stroke time of the $I\ 52$ valve before executing the regulation and every 24 hours.

The valve runs through a reset cycle every day at 01:00 a.m. before resuming regulation if a THS2 is connected to the THS2-0MM.

• 3-point, 2-pipe COOLING regulation ($I\bar{0}1=0$)

The "COOL" icon lights up to indicate the cooling function.

Define the following settings to use a 3-point cooling valve:

- Select digital output for controlling the opening of the 3-point on/off cooling valve $I\bar{0}4=2$ and $I\ 15=17$ (DO1) or $I\ 16=17$ (DO2) or $I\ 17=17$ (DO3) or $I\ 19=17$ (DO5) or $I\ 20=17$ (DO6),
- Select digital output for controlling the closure of the 3-point on/off cooling valve $I\ 15=18$ (DO1) or $I\ 16=18$ (DO2) or $I\ 17=18$ (DO3) or $I\ 19=18$ (DO5) or $I\ 20=18$ (DO6),
- Set the valve stroke time with parameter $I\ 52$.

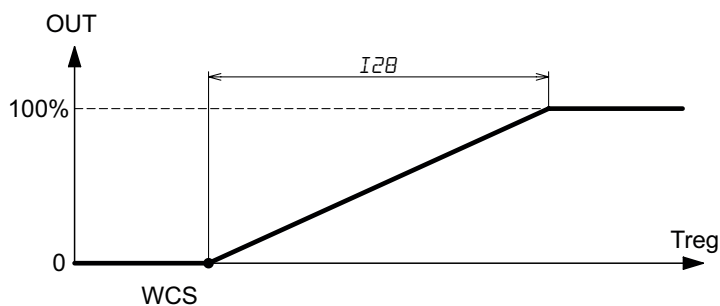

Treg: regulation sensor
WCS: calculated cooling setpoint
OUT: 3-point on/off cooling output
I28: proportional cooling band

If the operating temperature rises above the *WCS*, the 3-point valve begins to open. The ❄️ icon lights up. The valve can be regulated with PI action, if the integral time *I30* does not equal 0, or with proportional action only, if *I30*=0. The ❄️ icon turns off, if the 3-point valve closes.

Note: the icons indicated are present on an optional THS2 connected to the THS2-0MM.

When the controller is switched on, the valve runs through a reset cycle (valve closure) for 120% of the stroke time of the *I52* valve before executing the regulation and every 24 hours.

The valve runs through a reset cycle every day at 01:00 a.m. before resuming regulation if a THS2 is connected to the THS2-0MM.

• 3-point, 4-pipe regulation (I0 1=1)

Define the following settings to specify a 3-point heating valve:

- Select digital output for controlling the opening of the 3-point on/off heating valve *I03*=4 and *I15*=15 (DO1) or *I16*=15 (DO2) or *I17*=15 (DO3) or *I19*=15 (DO5) or *I20*=15 (DO6),

- Select digital output for controlling the closure of the 3-point on/off heating valve *I15*=16 (DO1) or *I16*=16 (DO2) or *I17*=16 (DO3) or *I19*=16 (DO5) or *I20*=16 (DO6).

Define the following settings to specify a 3-point cooling valve:

- Select digital output for controlling the opening of the 3-point on/off cooling valve *I04*=2 and *I15*=17 (DO1) or *I16*=17 (DO2) or *I17*=17 (DO3) or *I19*=17 (DO5) or *I20*=17 (DO6),

- Select digital output for controlling the closure of the 3-point on/off cooling valve *I15*=18 (DO1) or *I16*=18 (DO2) or *I17*=18 (DO3) or *I19*=18 (DO5) or *I20*=18 (DO6),

- Set the valve stroke time with parameter *I52*.

PI-type regulation operates as follows for 3-point regulation:

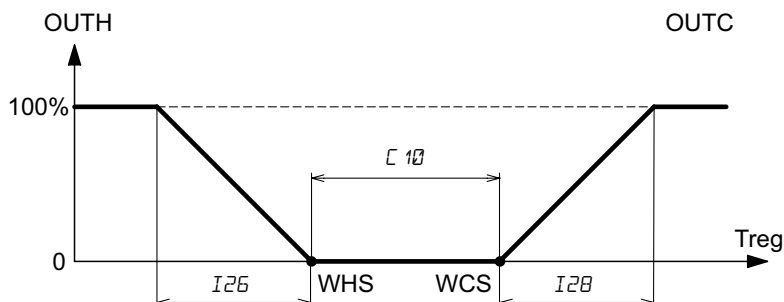

Treg: regulation sensor
WHS: calculated heating setpoint
WCS: calculated cooling setpoint
I10: neutral zone
I27: proportional heating band
I28: proportional cooling band
OUTH: 3-point on/off heating output
OUTC: 3-point on-off cooling output

If the operating temperature drops below the *WHS*, the 3-point heating valve begins to open. The ☀️ icon lights up. The 3-point valve can be regulated with PI action, if the integral heating time *I28* does not equal 0, or with proportional action

only, if $I28=0$.

The  icon turns off, if the 3-point heating valve closes when $Treg \geq WHS$.

If the operating temperature rises above the WCS , the 3-point cooling valve begins to open. The  icon lights up.

The 3-point valve can be regulated with PI action, if the integral heating time $I30$ does not equal 0, or with proportional action only, if $I30=0$.

The  icon turns off, if the 3-point valve closes when $Treg \leq WCS$.

Note: the icons indicated are present on an optional THS2 connected to the THS2-0MM.

When the controller is switched on, the valves run through a reset cycle (valve closure) for 120% of the stroke time of the $I52$ valve before executing the regulation and every 24 hours.

The valves run through a reset cycle every day at 01:00 a.m. before resuming regulation if a THS2 is connected to the THS2-0MM.

14. Mixed-use valve

The mixed-use valve can be regulated only in 2-pipe mode ($I01=0$).

To specify a mixed-use modulating valve, set parameters $I03=2$ and $I04=1$ and choose the modulating output configured as a mixed-use modulating valve $I21=4$ (AO1) or $I22=4$ (AO2) or $I23=4$ (AO3).

To specify an on/off mixed-use valve, set parameters $I03=4$ and $I04=2$ and choose the digital output configured as mixed-use on/off valve $I15=6$ (DO1) or $I16=6$ (DO2) or $I17=6$ (DO3) or $I18=6$ (DO4) or $I19=6$ (DO5) or $I20=6$ (DO6).

Regulation in 2-pipe heating mode ($I01=0$) is performed according to the logic of paragraph [“2-pipe HEATING regulation \(I01=0\)” page 26](#) and in cooling mode, according to the logic of paragraph [“2-pipe COOLING regulation \(I01=0\) without mid-season changeover \(M13=0\)” page 27](#).

To specify a 3-point mixed-use valve, set parameters $I03=4$ and $I04=2$ and

- select digital output for controlling the opening of the 3-point on/off mixed-use valve $I15=19$ (DO1) or $I16=19$ (DO2) or $I17=19$ (DO3) or $I19=19$ (DO5) or $I20=19$ (DO6),

- select digital output for controlling the closure of the 3-point on/off mixed-use valve $I15=20$ (DO1) or $I16=20$ (DO2) or $I17=20$ (DO3) or $I19=20$ (DO5) or $I20=20$ (DO6).

- set the valve stroke time with parameter $I52$.

Regulation in 2-pipe heating mode ($I01=0$) is performed according to the logic of paragraph [“3-point, 2-pipe HEATING regulation \(I01=0\)” page 32](#) and in cooling mode, according to the logic of paragraph [“3-point, 2-pipe COOLING regulation \(I01=0\)” page 32](#).

15. Supplemental battery logics

The supplemental battery is used as an additional heating stage and can be a modulating resistance ($I05=2$), or an on/off resistance ($I05=1$).

The supplemental battery uses the regulation sensor and the current working setpoint for regulation.

Regulation is proportional if the battery is modulating, and on/off in other cases. Parameter $I27$ represents the proportional band and parameter $I31$ the hysteresis of the supplemental heating stage.

• Supplemental modulating battery function:

- Integrative stage with electrical resistance: $I05=2$ and $I21=9$ (AO1) or $I22=9$ (AO2) or $I23=9$ (AO3).

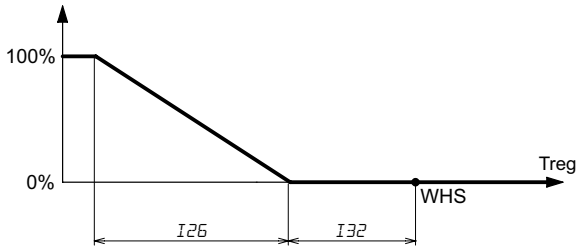

$Treg$: regulation temperature

WHS : calculated heating setpoint

$I33$: differential between stages

$I27$: proportional heating band

During regulation, the \heartsuit icon lights up, if the signal applied to the supplemental modulating resistance is not equal to 0:
 $Tsup < WHS - I33$.

The \heartsuit icon turns off, if the signal applied to the supplemental modulating resistance is equal to 0:

$Tsup \geq WHS - I33$. If the main heating stage is an electrical resistance and is still activated, the icon \heartsuit remains on.

Note: the icons indicated are present on an optional THS2 connected to the THS2-0MM.

• Supplemental on/off battery function:

- Integrative stage with electrical resistance: $I05=1$ and $I15=8$ (DO1) or $I16=8$ (DO2) or $I17=8$ (DO3) or $I18=8$ (DO4) or $I19=8$ (DO5) or $I20=8$ (DO6).

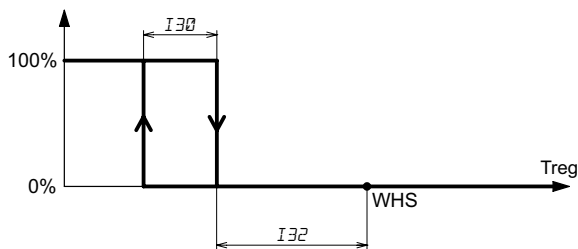

$Treg$: regulation temperature

WHS : calculated heating setpoint

$I33$: differential between stages

$I31$: hysteresis for on/off heating output

If $Treg < WHS - I33 - I31$, the supplemental stage in heating mode is activated, and the \heartsuit icon lights up.

If $Treg \geq WHS - I33$, the supplemental stage in heating mode is deactivated. The \heartsuit icon turns off, but if the main heating stage is an electrical resistance and is still activated, the icon \heartsuit remains on.

Note: the icons indicated are present on an optional THS2 connected to the THS2-0MM.

16. Pump

In 2-pipe systems, the pump, that deliver water to the fan coil units, can be controlled directly by any unit by selecting a dedicated digital output $I\ 15=10$ (DO1) or $I\ 16=10$ (DO2) or $I\ 17=10$ (DO3) or $I\ 18=10$ (DO4) or $I\ 19=10$ (DO5) or $I\ 20=10$ (DO6). If there is a regulation request for any valve, the pump will be activated. If, on the other hand, there is no valve regulation request, the pump will be deactivated.

17. CO₂-based damper regulation

It is possible to regulate a modulating or on/off damper according to the CO₂ level in order to implement a renewal of the ambient air. The CO₂ level is controlled by a remote CO₂ transmitter with 0..10 V output connected on the internal network, or it can be a value provided by the supervisor (virtual transmitter).

• Use of modulating damper:

To use a modulating damper that is regulated according to the CO₂ level detected by an air quality transmitter, set up as follows:

- connect a remote transmitter TCO2A(-D)-M to the internal network with address=20, baud rate=9600 bit/s, even parity,
- select the dedicated modulating output for this mode $I\ 21=5$ (AO1) or $I\ 22=5$ (AO2) or $I\ 23=5$ (AO3),
- CO₂ setpoint $\epsilon\ 17$,
- CO₂ proportional band $\epsilon\ 18$,
- transmitter present $M\ 21=1$

To use a modulating damper that is regulated according to the CO₂ level provided by the supervisor, input the following settings:

- write the value 22222 to indicate presence of supervisor on variable STATUS_PRESENCE_SUPERVISOR_DISPLAY (11033)
- write the value of CO₂ in variable ADR_MOD_FORCE_TRASM_CO2 (11047) between 0 and 2000 (a value of -200 excludes the presence of virtual transmitter).
- select the dedicated modulating output for this mode $I\ 21=5$ (AO1) or $I\ 22=5$ (AO2) or $I\ 23=5$ (AO3),
- CO₂ setpoint $\epsilon\ 17$,
- CO₂ proportional band $\epsilon\ 18$.

The air renewal signal is calculated according to the curve below:

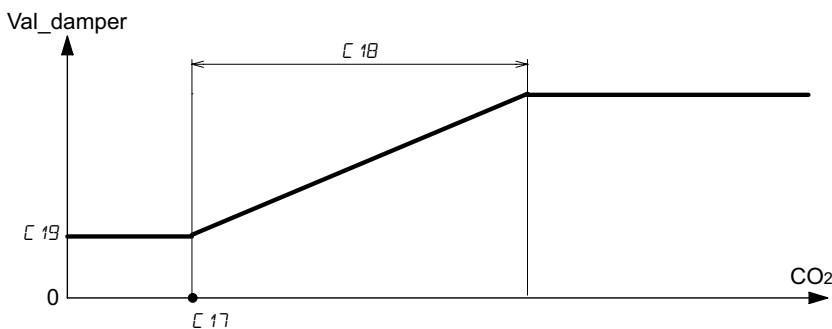

CO₂: level of CO₂ detected by the remote CO₂ air quality transmitter or value forced by the supervisor

Val_damper: theoretical percentage of air renewal

$\epsilon\ 17$: CO₂ setpoint

$\epsilon\ 18$: proportional band or CO₂ hysteresis

$\epsilon\ 19$: minimum opening of modulating damper

When the signal applied to the CO₂ > $\epsilon\ 17$, the damper is regulated proportionally according to the proportional band $\epsilon\ 18$ and the  icon lights up.

If the CO₂ <= $\epsilon\ 17$, the damper takes the position of the minimum opening, and the  icon turns off.

Note: the icons indicated are present on an optional THS2 connected to the THS2-0MM.

• Use of on/off damper:

To use an on/off damper that is regulated according to the CO₂ level detected by an air quality transmitter, input the following

settings:

- connect a remote transmitter TCO2A(-D)-M to the internal network with address=20, baud rate=9600 bit/s, even parity,
- select the dedicated on/off output for this function $I_{15}=11$ (DO1) or $I_{16}=11$ (DO2) or $I_{17}=11$ (DO3) or $I_{18}=11$ (DO4) or $I_{19}=11$ (DO5) or $I_{20}=11$ (DO6),
- CO₂ setpoint ϵ_{17} ,
- CO₂ proportional band ϵ_{18}
- transmitter present $M21=1$

To use an on/off damper adjusted according to the CO₂ level provided by the supervisor, input the following settings:

- write the value 22222 to indicate presence of supervisor on variable **STATUS_PRESENCE_SUPERVISOR_DISPLAY** (11033)
- write the value of CO₂ in variable **ADR_MOD_FORCE_TRASM_CO2** (11047) between 0 and 2000 (a value of -200 excludes the presence of virtual transmitter)
- select the dedicated on/off output for this function $I_{15}=11$ (DO1) or $I_{16}=11$ (DO2) or $I_{17}=11$ (DO3) or $I_{18}=11$ (DO4) or $I_{19}=11$ (DO5) or $I_{20}=11$ (DO6),
- CO₂ setpoint ϵ_{17} ,
- CO₂ proportional band ϵ_{18}

The air renewal signal is calculated according to the curve below:

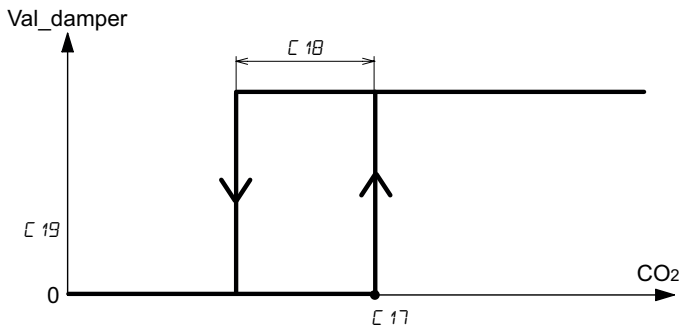

CO₂: level of CO₂ detected by the remote CO₂ air quality transmitter or value forced by the supervisor

Val_damper: theoretical percentage of air renewal

ϵ_{17} : CO₂ setpoint

ϵ_{18} : proportional band or CO₂ hysteresis

If the CO₂ signal $> \epsilon_{17}$, the damper opens, and the icon lights up

If the CO₂ signal $\leq \epsilon_{17} - \epsilon_{18}$, the damper closes, and the icon turns off

Note: the icons indicated are present on an optional THS2 connected to the THS2-0MM.

18. Dehumidifier

Dehumidification can be achieved with

- an on/off dehumidifier
- a modulating dehumidifier

The humidity can be controlled with the humidity sensor inside the optional THS2 connected to a THS2-0MM controller, by a remote humidity transmitter with a 0..10 V output connected to the internal network or with a value supplied by the supervisor (virtual transmitter).

• Use of a modulating dehumidifier:

To use a modulating dehumidifier that is regulated according to the humidity detected by the internal humidity sensor of THS2 connected to a THS2-0MM controller, define the following settings:

- select the dedicated modulating output for this mode $I21=6$ (AO1) or $I22=6$ (AO2) or $I23=6$ (AO3),
- humidity setpoint $C20$,
- humidity proportional band $C21$.
- set $M22=0$ on THS2.

To use a modulating dehumidifier that is regulated according to the humidity detected by a remote transmitter, define the following settings:

- connect a remote transmitter TUA(-D)-M to the internal network with address=20, baud rate=9600 bit/s, even parity,
- select the dedicated modulating output for this mode $I21=7$ (AO1) or $I22=7$ (AO2) or $I23=7$ (AO3),
- humidity setpoint $C20$,
- humidity proportional band $C21$,
- transmitter present $M21=1$.

To use a modulating dehumidifier that is regulated according to the humidity provided by the supervisor, input the following settings:

- write the value 22222 to indicate presence of supervisor on variable **STATUS_PRESENCE_SUPERVISOR_DISPLAY** (11033)
- write the value of humidity in variable **ADR_MOD_FORCE_TRASM_HUM** (11046)
- select the dedicated modulating output for this mode $I21=7$ (AO1) or $I22=7$ (AO2) or $I23=7$ (AO3),
- humidity setpoint $C20$,
- humidity proportional band $C21$.

The dehumidify signal is calculated according to the curve below:

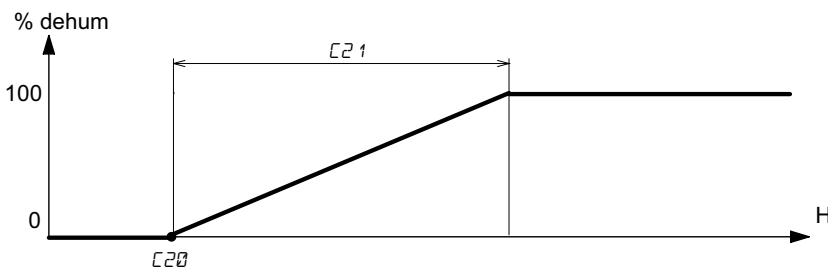

H: humidity level detected by the internal or remote humidity sensor or provided by the supervisor

% dehum: theoretical percentage dehumidification

$C20$: humidity setpoint

$C21$: proportional band or humidity hysteresis

Regulation is implemented at humidity setpoint $C20$ and is proportional.

When the signal applied to the dehumidifier is not equal to 0, the  icon lights up.

Note: the icons indicated are present on an optional THS2 connected to the THS2-0MM.

• Use of an on/off dehumidifier:

To use an on/off dehumidifier that is regulated according to the humidity detected by the internal humidity sensor of THS2 connected to a THS2-0MM controller, input the following settings:

- select the dedicated on/off output for this mode $I15=12$ (DO1) or $I16=12$ (DO2) or $I17=12$ (DO3) or $I18=12$ (DO4) or $I19=12$ (DO5) or $I20=12$ (DO6),
- humidity setpoint $C20$,

- humidity proportional band $\mathcal{L}21$
- set $M22=0$ on THS2.

To use a on/off dehumidifier that is regulated according to the humidity detected by a remote transmitter, input the following settings:

- connect a remote transmitter TUA(-D)-M to the internal network with address=20, baud rate=9600 bit/s, even parity,
- select the dedicated on/off output for this mode $I15=13$ (DO1) or $I16=13$ (DO2) or $I17=13$ (DO3) or $I18=13$ (DO4) or $I19=13$ (DO5) or $I20=13$ (DO6),
- humidity setpoint $\mathcal{L}20$,
- humidity proportional band $\mathcal{L}21$,
- transmitter present $M21=1$.

To use an on/off dehumidifier that is regulated according to the humidity provided by the supervisor, input the following settings:

- write the value 22222 to indicate presence of supervisor on variable **STATUS_PRESENCE_SUPERVISOR_DISPLAY** (11033)
- write the value of humidity in variable **ADR_MOD_FORCE_TRASM_HUM** (11046)
- select the dedicated on/off output for this mode $I15=13$ (DO1) or $I16=13$ (DO2) or $I17=13$ (DO3) or $I18=13$ (DO4) or $I19=13$ (DO5) or $I20=13$ (DO6),
- humidity setpoint $\mathcal{L}20$,
- humidity proportional band $\mathcal{L}21$.

The dehumidify signal is calculated according to the curve below:

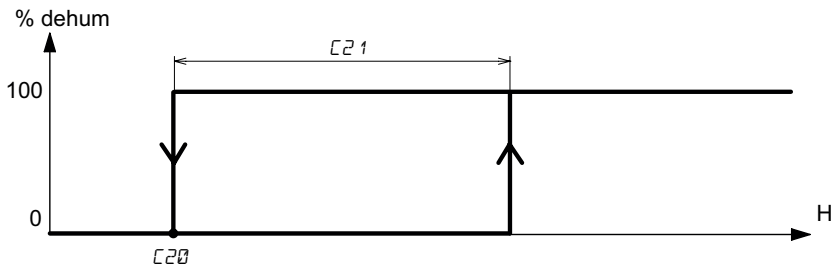

H: humidity level detected by the internal or remote humidity sensor or provided by the supervisor

% dehum: theoretical percentage dehumidification

$\mathcal{L}20$: humidity setpoint

$\mathcal{L}21$: proportional band or humidity hysteresis

Regulation is implemented at the humidity setpoint $\mathcal{L}20$ and is on/off.

If the detected humidity $> \mathcal{L}20 + \mathcal{L}21$, the dehumidifier is activated, and the  icon lights up.

If the detected humidity $\leq \mathcal{L}20$, the dehumidifier is deactivated, and the  icon turns off.

Note: the icons indicated are present on an optional THS2 connected to the THS2-0MM.

19. Fan coil unit with EC motor

The slave units are able to control EC motor via 0..10 V analogue output, with or without a relay for the EC motor. If there is an EC motor relay, the relay output is activated first when the motor is started, while the analogue output remains at 0 V. After 1 second, the analogue output is activated.

To control an EC motor, input the following settings:

- $I05=2$ (modulating fan coil unit),

- select the analogue output to control the motor $I21=1$ (AO1) or $I22=1$ (AO2) or $I23=1$ (AO3),

- for EC motor with auxiliary relay, select the digital output to control the EC motor relay $I15=9$ (DO1) or $I16=9$ (DO2) or $I17=9$ (DO3) or $I18=9$ (DO4) or $I19=9$ (DO5) or $I20=9$ (DO6),

Set the EC motor parameters as follows:

- set the voltage corresponding to the minimum speed of the EC motor using parameter $I37$.

- set the voltage corresponding to the maximum speed of the EC motor using parameter $I38$.

- set parameters $I41$, $I42$ and $I43$ to specify speeds 1, 2 and 3, respectively.

Example: If $I37=1V$, $I38=8V$ and $I41=10\%$, speed 1 is $1.7V \rightarrow [I41 \times (I38 - I37) + I37]$

Automatic speed regulation occurs linearly between speeds 1 and 3, while manual speed regulation is at the fixed speed selected manually (see ["33. Setting parameters using quick access on THS2" page 54](#)).

To match speed 1 to the minimum EC motor speed, set $I41$ to 0.

To match speed 3 to the maximum EC motor speed, set $I43$ to 100.

To have speed 2 in the centre between speeds 1 and 3 of the EC motor, set $I42$ to 50.

• Automatic speed control logic for EC motor with on/off outputs in heating mode

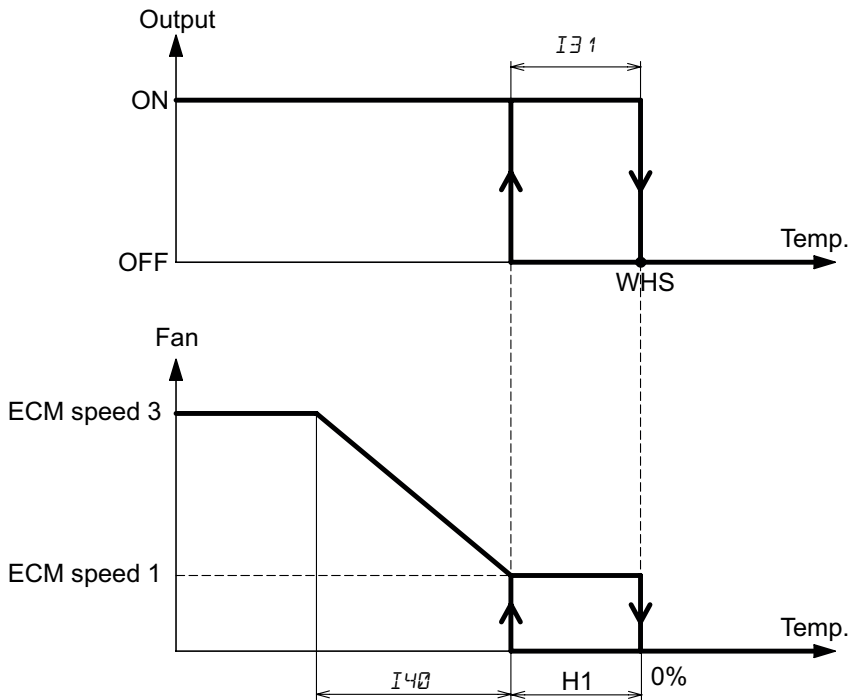

Temp: operating temperature

WHS: calculated heating setpoint

H1: fan starting point, $H1=I31$

$I31$: heating hysteresis

$I40$: EC fan coil unit proportional band

The activation and deactivation of the fan coil unit at speed 1 corresponds to the activation and deactivation of the heating stage.

If $Temp < WHS - I31$, the fan coil unit activates at speed 1 and, as the temperature decreases, the speed increases linearly (if Temp rises, the fan stops, if $Temp \geq WHS$).

If $Temp < WHS - I31 - I40$, the fan coil unit reaches the maximum speed 3.

If $Temp \geq WHS$, heating stage is off. The fan coil unit stops after the minimum switch-off delay $I45$ has elapsed. If $I45=0$, a minimum delay of 30 s is applied.

When the fan coil unit is activated at speed 1, the icon lights up.

When the speed exceeds the threshold corresponding to the percentage of valve opening defined by parameter $I42$ (EC motor speed 2), the icons light up.

When the speed exceeds the threshold corresponding to the percentage of valve opening defined by parameter $I43$ (EC motor speed 3), the  icons light up.

Note: If there is a supplemental modulating heating stage (stage 2) with $I33 < H1$, the starting point of the fan at speed 1 becomes $WHS - I33$.

Note: the icons indicated are present on an optional THS2 connected to the THS2-0MM.

• **Automatic speed control logic for EC motor with on/off outputs in cooling mode**

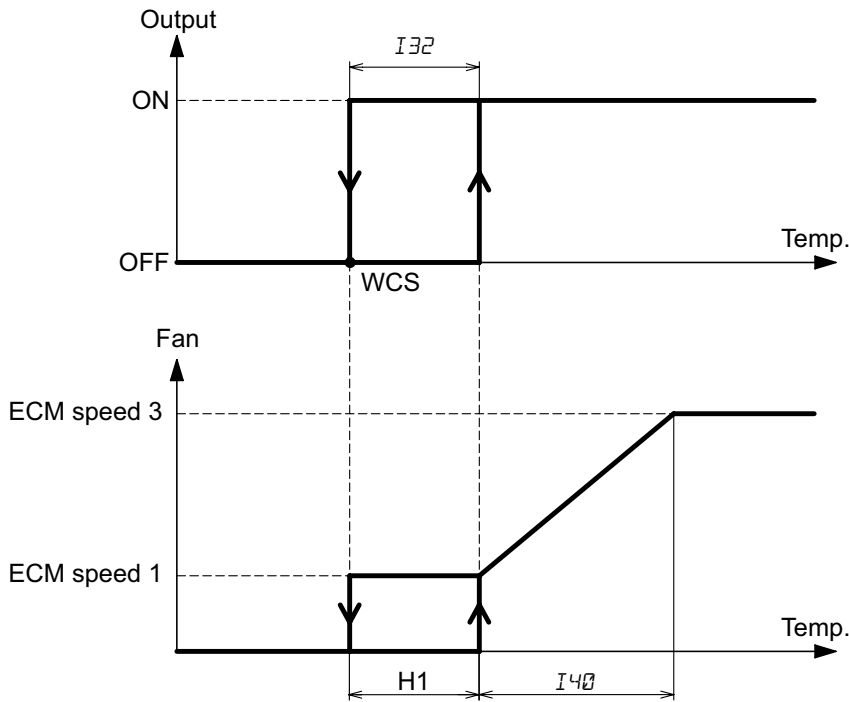

Temp: operating temperature

WCS: calculated cooling setpoint

H1: fan starting point, $H1=I32$

$I32$: cooling hysteresis

$I40$: EC fan coil unit proportional band

The activation and deactivation of the fan coil unit at speed 1 correspond to the activation and deactivation of the cooling stage.

If $Temp > WCS + I32$ the fan coil unit activates at speed 1 and, as the temperature increases, the speed increases linearly, (if Temp drops, the fan stops, if $Temp \leq WCS$)

If $Temp > WCS + I32 + I40$, the fan coil unit reaches the maximum speed 3.

If $Temp \leq WCS$, cooling stage is off. The fan coil unit stops after the minimum switch-off delay $I45$ has elapsed.

When the fan coil unit is activated at speed 1, the  icon lights up.

When the speed exceeds the threshold corresponding to the percentage of valve opening defined by parameter $I42$ (EC motor speed 2), the  icons light up.

When the speed exceeds the threshold corresponding to the percentage of valve opening defined by parameter $I43$ (EC motor speed 3), the  icons light up.

Note: the icons indicated are present on an optional THS2 connected to the THS2-0MM.

- **Automatic speed control logic for EC motor with 0..10 V or 3-point outputs in heating mode**

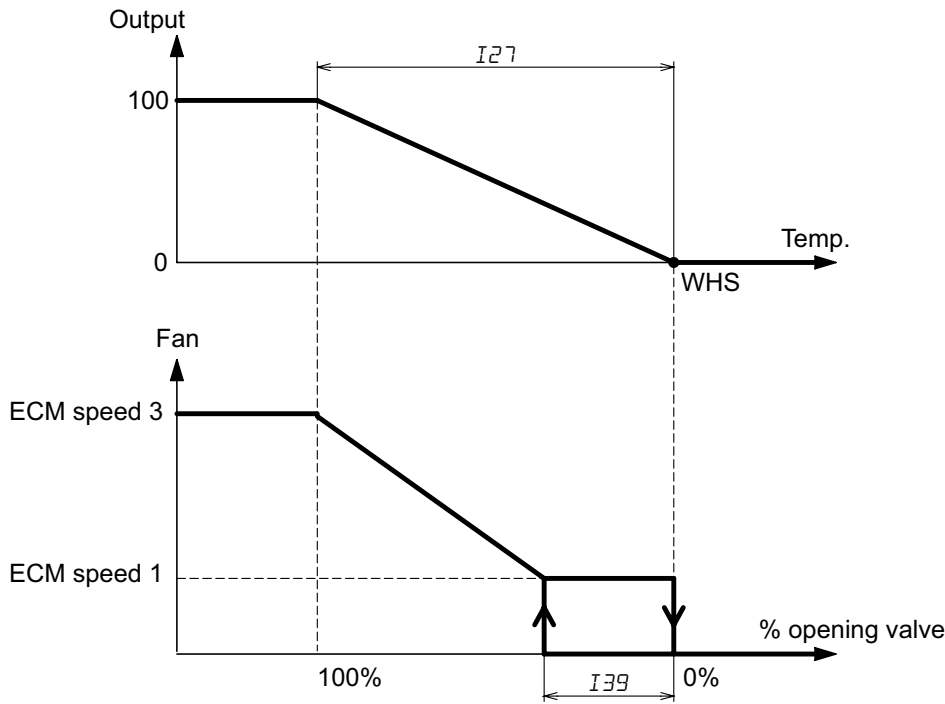

Temp: operating temperature

WHS: calculated heating setpoint

I27: proportional heating band

I39: starting point of EC fan coil unit (%), if the heating outlet is a valve. If the heating output is an electrical resistance, the starting point for the EC fan coil unit becomes the WHS

Set parameter *I39* to specify when to start the motor with respect to the opening percentage of the heating valve. This allows the fan coil unit to be started when the water is already circulating in the fan coil unit battery and has already heated the heating battery.

If the valve opens by the percentage defined by parameter *I39*, the fan coil unit is activated at speed 1. If the valve continues to open, the speed of the fan coil unit increases to speed 3, when the heating valve is fully open ($Temp < WHS - I27$). If *Temp* rises, the valve starts to close, and the fan stops when $Temp \geq WHS$ after the minimum switch-off delay *I45* has elapsed. If *I45*=0, a minimum delay of 30 s is applied.

Example: If *I39*=5%, the motor starts when the modulating output of the valve exceeds 0.5V $\rightarrow [I39 \times 10 \text{ V}]$. The fan coil unit is stopped, when the valve closes.

When the fan coil unit is activated at speed 1, the icon lights up.

When the speed exceeds the threshold corresponding to the percentage of valve opening defined by parameter *I42* (EC motor speed 2), the icons light up.

When the speed exceeds the threshold corresponding to the percentage of valve opening defined by parameter *I43* (EC motor speed 3), the icons light up.

Notes:

- The icons indicated are present on an optional THS2 if connected to the THS2-0MM.

- If an electrical resistance is being controlled instead of the valve, parameter *I39* is no longer considered. If the signal applied to the modulating electrical resistance is not equal to 0, the fan coil unit is started at speed 1 and increases as the signal applied to the electrical resistance increases. If the electrical resistance signal goes to 0, the fan coil unit stops after the minimum switch-off delay *I45* has elapsed. If *I45*=0, a minimum delay of 30 s is applied.

If there is a supplemental modulating heating stage (stage 2), and if $WHS - I39$ corresponds to a higher opening than the minimum valve opening *I39*, the starting point of the fan at speed 1 becomes $WHS - I39$.

- **Automatic speed control logic for EC motor with 0..10 V or 3-point outputs in cooling mode**

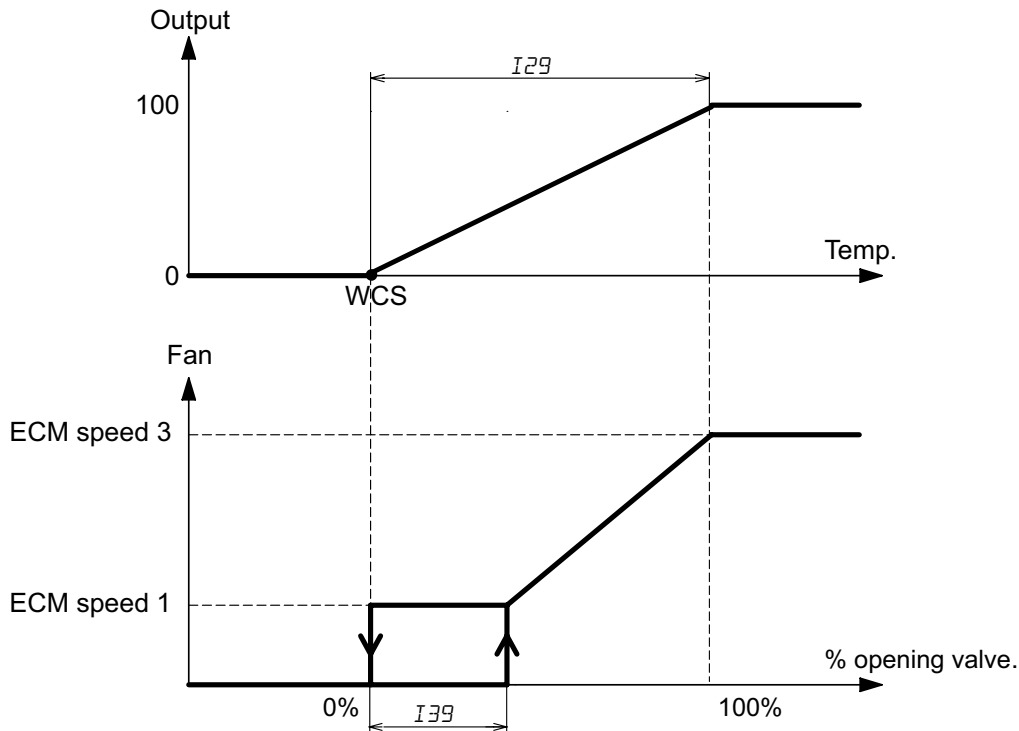

Temp: operating temperature
WCS: calculated cooling setpoint
I29: proportional cooling band
I39: starting point of EC fan coil unit (%)

Set parameter I39 to specify when to start the motor relative to the opening percentage of the cooling valve. This allows the fan coil unit to be started when water is already circulating in the fan coil unit and has already cooled the cooling battery.

If the valve opens by the percentage defined by parameter I39, the fan coil unit is activated at speed 1. If the valve continues to open, the speed of the fan coil unit increases to speed 3, when the cooling valve is fully open (Temp > WCS + I29). If Temp decreases, the valve starts to close, and the fan stops when Temp <= WCS after the minimum switch-off delay I45 has elapsed.

Example: If I39=5%, the motor starts when the modulating output of the valve exceeds 0.5V → [I39x10 V]. The fan coil unit is stopped, when the valve closes.

Once the fan coil unit has started, if the modulating output of the valve continues to increase, the fan coil unit speed increases to speed 3 when the cooling valve is fully open.

When the fan coil unit is activated at speed 1, the ▲ icon lights up.

When the speed exceeds the threshold corresponding to the percentage of valve opening defined by parameter I42 (EC motor speed 2), the ▲▲ icons light up.

When the speed exceeds the threshold corresponding to the percentage of valve opening defined by parameter I43 (EC motor speed 3), the ▲▲▲ icons light up.

Note: the icons indicated are present on an optional THS2 connected to the THS2-0MM.

20. Fan coil unit with 3-speed on/off motor

The slave units can handle 3-speed on-off type fan coil units.

To control a 3-speed motor, input the following settings:

- $I05=1$ (3-speed, on/off fan coil unit),

- select digital output to control speed 1 $I15=1$ (DO1) or $I16=1$ (DO2) or $I17=1$ (DO3) or $I18=1$ (DO4) or $I19=1$ (DO5) or $I20=1$ (DO6),

- select digital output to control speed 2 $I15=2$ (DO1) or $I16=2$ (DO2) or $I17=2$ (DO3) or $I18=2$ (DO4) or $I19=2$ (DO5) or $I20=2$ (DO6),

- select digital output to control speed 3 $I15=3$ (DO1) or $I16=3$ (DO2) or $I17=3$ (DO3) or $I18=3$ (DO4) or $I19=3$ (DO5) or $I20=3$ (DO6).

Automatic speed regulation takes place between speeds 1, 2 and 3, while manual speed regulation is at the fixed speed selected manually (see "[33. Setting parameters using quick access on THS2](#)" page 54).

• Automatic speed control logic for 3-speed on/off motors with 0..10 V or 3-point outputs in heating mode

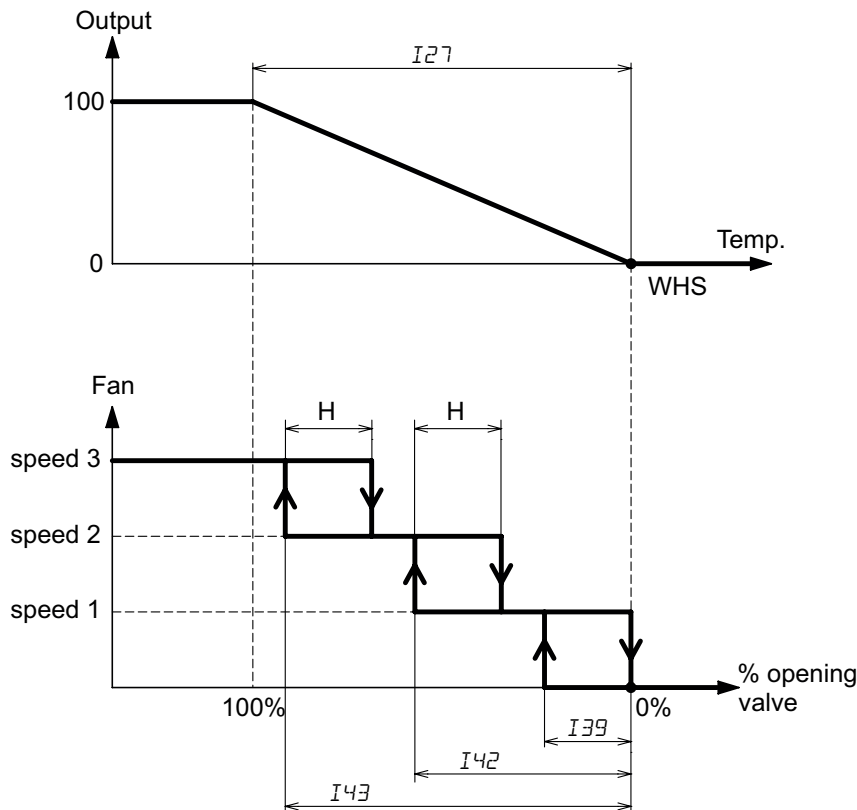

Temp: operating temperature

WHS: calculated heating setpoint

$I27$: proportional heating band

$I39$: starting point of fan coil unit corresponding to the opening $I39$ (%) of the valve, if the heating output at stage 1 is a valve. If the heating output is an electrical resistance, the starting point for the fan coil unit is the WHS.

$I42$: activation of speed 2 at $I42$ (%) valve opening

$I43$: activation of speed 3 at $I43$ (%) valve opening

H: hysteresis corresponding to 20% of full valve opening

- Set parameter $I39$ to specify the valve opening (%) at which speed 1 of the fan coil unit begins. This allows the fan coil unit to be started when the water is already circulating in the fan coil unit battery and has already heated the heating battery.

- Set parameters $I42$ and $I43$ to specify the valve opening (%) at which speeds 2 and 3 of the fan coil unit begin.

The hysteresis of speeds 2 and 3 is fixed and corresponds to 20% of the full valve opening.

The hysteresis of speed 1 corresponds to parameter $I39$.

Example:

If $I39=10\%$, $I42=65\%$, $I43=100\%$

Speed 1 is activated at 10% of full valve opening and is deactivated when the valve closes.

Speed 2 is activated at 65% and deactivated at 45% of full valve opening.

Speed 3 is activated at 100% and deactivated at 80% of full valve opening.

When speed 1 is on, the ▴ icon is lit if display terminal THS2 is connected
 When speed 3 is on, the ▴▴ icons are lit if display terminal THS2 is connected
 When speed 3 is on, the ▴▴▴ icons are lit if display terminal THS2 is connected

Notes:
 - Verify that the parameters are properly defined $I_{39} < I_{42}$ and $I_{42} < I_{43}$.
 - The icons indicated are present on an optional THS2 if connected to the THS2-0MM.
 - If an electrical resistance is being controlled instead of the valve, parameter I_{39} is no longer considered. If the signal applied to the modulating electrical resistance is not equal to 0, the fan coil unit is started at speed 1, and the speed increases as the signal applied to the electrical resistance increases according to the previously defined activation points. If the electrical resistance signal goes to 0, the fan coil unit stops after the minimum switch-off delay I_{45} has elapsed. If $I_{45}=0$, a minimum delay of 30 s is applied.
 If there is a supplemental modulating heating stage (stage 2), and if WHS - I_{33} corresponds to a higher opening than the minimum valve opening I_{39} , the starting point of the fan at speed 1 becomes WHS - I_{33} .

• Automatic speed control logic for 3-speed on/off motors with 0..10 V or 3-point cooling outputs

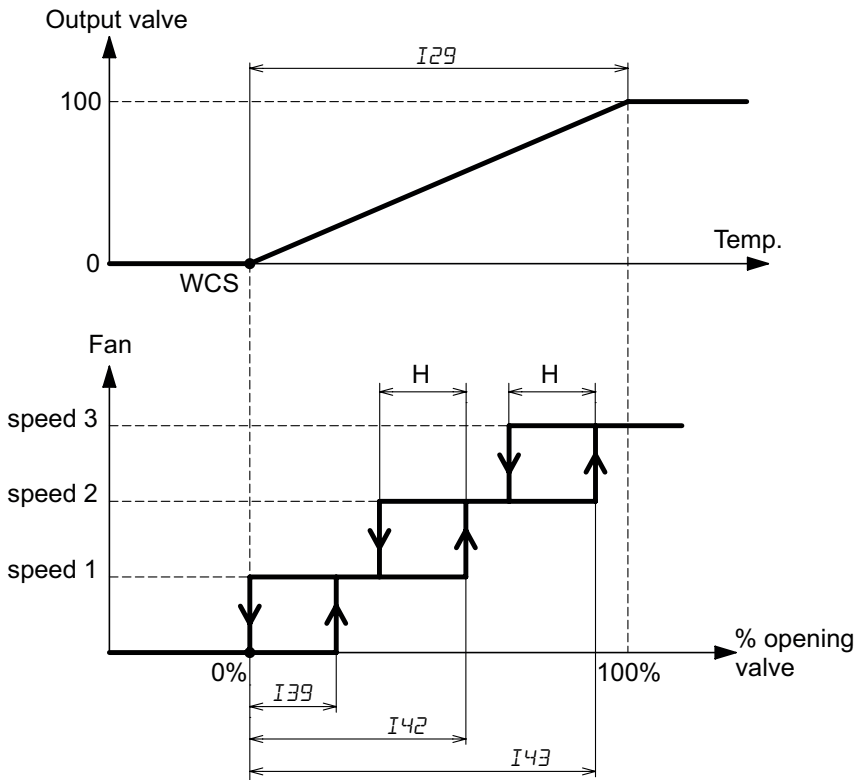

Temp: operating temperature
WCS: calculated cooling setpoint
I29: proportional cooling band
I39: fan coil unit starting point at valve opening I39(%)
I42: activation of speed 2 at I42(%) valve opening
I43: activation of speed 3 at I43(%) valve opening
H: hysteresis corresponding to 20% of full valve opening

- Set parameter I_{39} to specify the valve opening (%) at which speed 1 of the fan coil unit begins. This allows the fan coil unit to be started when the water is already circulating in the fan coil unit battery and has already cooled the cooling battery.
 - Set parameters I_{42} and I_{43} to specify the valve opening (%) at which speeds 2 and 3 of the fan coil unit begin. The hysteresis of speeds 2 and 3 is fixed and corresponds to 20% of the full valve opening. The hysteresis of speed 1 corresponds to parameter I_{39} .

Example:
 If $I_{39}=10\%$, $I_{42}=65\%$, $I_{43}=100\%$
 Speed 1 is activated at 10% of full valve opening and is deactivated when the valve closes.
 Speed 2 is activated at 65% and deactivated at 45% of full valve opening.
 Speed 3 is activated at 100% and deactivated at 80% of full valve opening.
 Note: verify that the parameters are properly defined $I_{39} < I_{42}$ and $I_{42} < I_{43}$

When speed 1 is on, the ▴ icon is lit if display terminal THS2 is connected
 When speed 2 is on, the ▴▴ icons are lit if display terminal THS2 is connected
 When speed 3 is on, the ▴▴▴ icons are lit if display terminal THS2 is connected

Note: the icons indicated are present on an optional THS2 connected to the THS2-0MM.

• **Automatic speed control logic for 3-speed on/off motors with on/off outputs in heating mode**

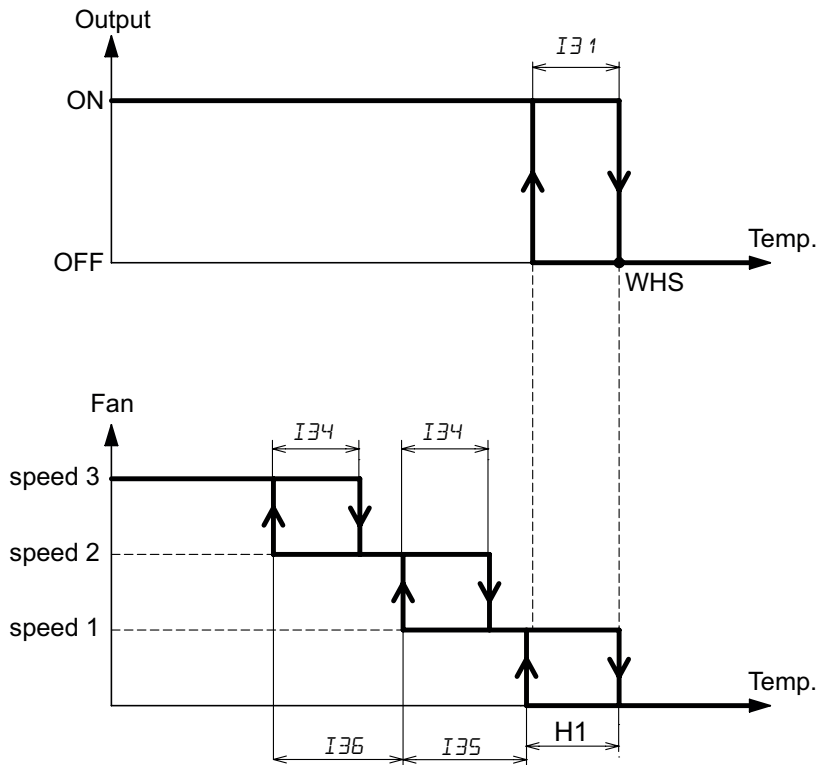

Temp: operating temperature
WHS: calculated heating setpoint
I31: heating hysteresis
H1: fan coil unit starting point at speed 1:
 $H1 = \max(I31, I34)$, if stage 1 heating output is a valve
 $H1 = I31$, if stage 1 heating output is an electrical resistance
I34: on/off speed hysteresis
I35: differential between speeds 1->2
I36: differential between speeds 2->3

- Select the common $I34$ hysteresis at speeds 2 and 3 (temperature difference between switching on and off at the same speed).
- If $I31 \leq I34$ the hysteresis of speed 1 is $I34$.
- If $I31 > I34$ the hysteresis of speed 1 is $I31$.
- Set the differential between speeds 1->2 $I35$.
- Set the differential between speeds 2->3 $I36$.
- Speed 1 starts up if $Temp < WHS - H1$ and turns off if $Temp \geq WHS$.
- Speed 2 starts up if $Temp < WHS - H1 - I35$ and turns off is $Temp \geq WHS - H1 - I35 + I34$.
- Speed 3 starts up if $Temp < WHS - H1 - I35 - I36$ and turns off if $Temp \geq WHS - H1 - I35 - I36 + I34$.

When speed 1 is on, the ▴ icon is lit if display terminal THS2 is connected
 When speed 2 is on, the ▴▴ icons are lit if display terminal THS2 is connected
 When speed 3 is on, the ▴▴▴ icons are lit if display terminal THS2 is connected

Notes:
 - The icons indicated are present on an optional THS2 if connected to the THS2-0MM.
 - If there is a supplemental modulating heating stage (stage 2) with $I33 < H1$, the starting point of the fan at speed 1 becomes $WHS - I33$.

• **Automatic speed control logic for 3-speed on/off motors with on/off outputs in cooling mode**

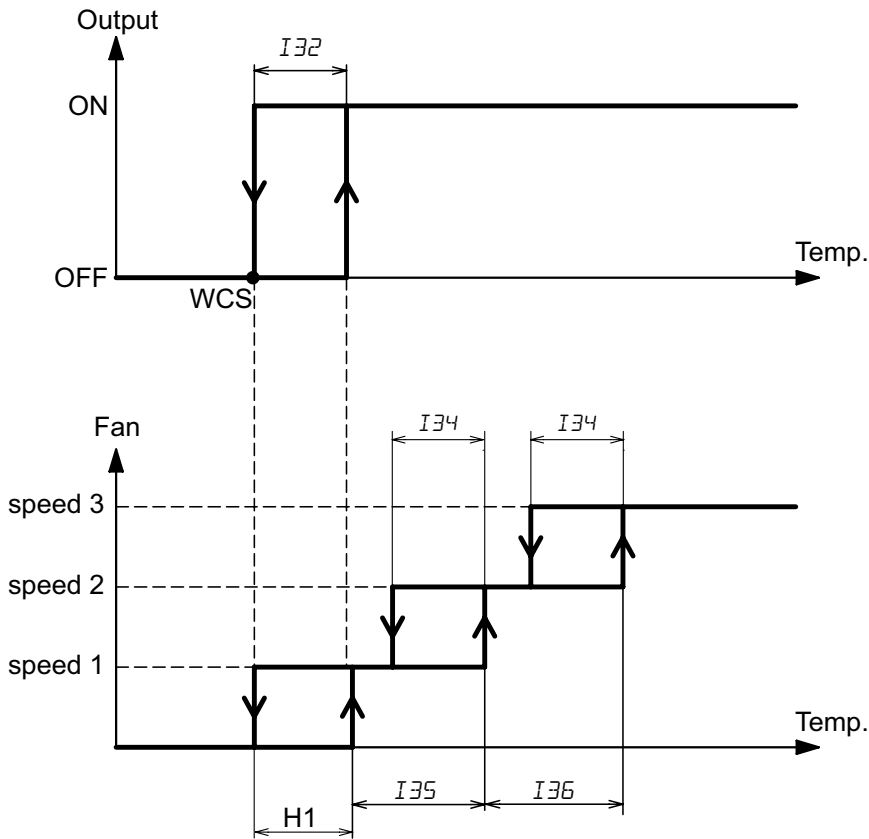

Temp: operating temperature

WCS: calculated cooling setpoint

I32: cooling hysteresis

H1: fan coil unit starting point at speed 1: $H1 = \max(I32 \text{ and } I34)$

I34: on/off speed hysteresis

I35: differential between speeds 1->2

I36: differential between speeds 2->3

- Select the common $I34$ hysteresis at speeds 2 and 3 (temperature difference between switching on and off at the same speed).

If $I32 \leq I34$ the hysteresis of speed 1 is $I34$.

If $I32 > I34$ the hysteresis of speed 1 is $I32$.

- Set the differential between speeds 1->2 $I35$.

- Set the differential between speeds 2->3 $I36$.

Speed 1 starts up if $\text{Temp} > \text{WCS} + H1$ and turns off if $\text{Temp} \leq \text{WCS}$.

Speed 2 starts up if $\text{Temp} > \text{WCS} + H1 + I35$ and turns off if $\text{Temp} \leq \text{WCS} + H1 + I35 - I34$.

Speed 3 starts up if $\text{Temp} > \text{WCS} + H1 + I35 + I36$ and turns off if $\text{Temp} \leq \text{WCS} + H1 + I35 + I36 - I34$.

When speed 1 is on, the ▽ icon is lit if display terminal THS2 is connected

When speed 2 is on, the ▴▽ icons are lit if display terminal THS2 is connected

When speed 3 is on, the ▴▴▽ icons are lit if display terminal THS2 is connected

Note: the icons indicated are present on an optional THS2 connected to the THS2-0MM.

21. Manual speeds and ventilation in the absence of regulation

Automatic speed or manual speeds 1, 2 or 3 can be selected for the regulation. See [“19. Fan coil unit with EC motor” page 40](#) or [“20. Fan coil unit with 3-speed on/off motor” page 44](#) for how to select the type of ventilation.

If the regulation speed is manual, it remains constant at the set speed once it has been started during the regulation phase.

When the setpoint is reached, the fan is stopped, if parameter $I47=0$.

It is possible to maintain speed 1, regardless of the type of speed used for regulation, or one of the manual speeds selected, even if the regulation does not require it. Continuous ventilation is thus maintained to allow the air to circulate.

To keep speed 1 active in the absence of regulation in cooling mode, set parameter $I47$ to 2.

To keep speed 1 active in the absence of regulation in heating mode, set parameter $I47$ to 3.

To keep speed 1 active regardless of the operating season and in the absence of regulation, set parameter $I47$ to 1.

To keep the selected manual speed active in the absence of regulation in cooling mode, set parameter $I47$ to 5.

To keep the selected manual speed active in the absence of regulation in heating mode, set parameter $I47$ to 6.

To keep the selected manual speed active regardless of the operating season and in the absence of regulation, set parameter $I47$ to 4.

To turn the ventilation off when the setpoint is reached, set parameter $I47$ to 0.

22. Fan boost

The boost function eliminates the problem of faulty engine start-up at low speeds.

With parameter $I46=1$, the motor always starts at maximum speed for 1 second and then reaches the speed required by the regulation.

If this function is not desired, set parameter $I46$ to 0.

With parameter $I46=0$, the motor starts directly at the speed requested by the regulation.

23. Minimum thermostat

For all operations in heating mode, if a digital input is used on the optional THS2 connected to the THS2-0MM master $M01=7$ or $M03=7$ or on the THS2-0MM $I07=6$ or $I09=6$ configured as minimum thermostat or a remote sensor configured as minimum thermostat $I11=3$ or $I13=3$, ventilation does not start until the minimum thermostat is considered closed.

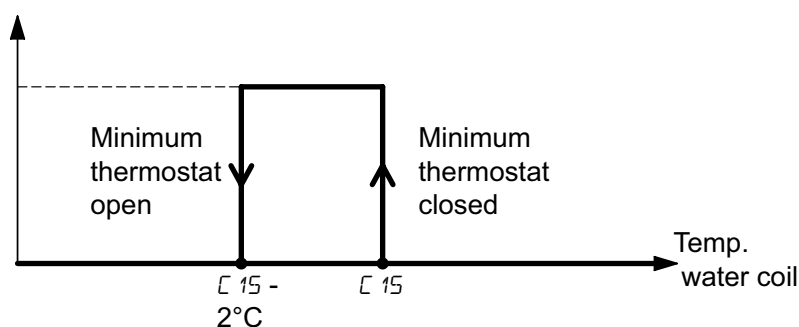

The contact position and the logic of the digital contact are considered in determining the closure of the minimum thermostat for digital contacts (see [“8. Logic of digital and analogue inputs THS2-0MM” page 16](#) and [“43. Logic of digital inputs THS2” page 77](#)).

The logic for analogue inputs is as follows:



Temp water coil: heating coil temperature

If the temperature of the heating battery sensor at power-on is between $\epsilon 15$ and $\epsilon 15 - 2$, the minimum thermostat is considered open.

In the absence of electrical resistance, the ,  and  icons light up in sequence, when the minimum thermostat is open during regulation in heating mode.

Notes:

- The icons indicated are present on an optional THS2 if connected to the THS2-0MM.

- If there is electrical resistance, the minimum thermostat function is not taken into account. The fan is activated immediately when the electrical resistance is activated, even if the minimum thermostat is considered open.

In the absence of regulation or in cooling mode, the minimum thermostat is not taken into account.

Setting done on optional THS2 connected to THS2-0MM master for minimum thermostat has higher priority than setting done locally on a THS2-0MM. So if a digital contact on THS2 connected to THS2-0MM master has the function of minimum thermostat, this contact set the position of minimum thermostat for whole internal network. If no digital contact is used on THS2 connected to THS2-0MM master with the function of minimum thermostat, the setting done locally on a THS2-0MM defines the position of minimum thermostat for that unit only. So for each THS2-0MM there must be a contact with minimum thermostat connected to use this function.

24. Destratification cycle

This function facilitates the prevention of air stratification and a better reading of the temperature of the remote sensor placed on the fan intake.

In the absence of regulation, if the fan is off ($I47=0$), it is possible to start the air destratification function taking the operating season into account.

To start the destratification function in both heating and cooling mode, set parameter $I48$ to 1.

To start the destratification function in heating mode only, set parameter $I48$ to 2.

To start the destratification cycle in cooling mode only, set parameter $I48$ to 3.

With the destratification cycle activated, the fan starts at speed 1, and the  icon flashes on an optional THS2 connected to a THS2-0MM for a length of time equal to parameter $I49$ with every time interval set with parameter $I50$.

25. Window contact

In all operations, if a digital input is used as a window contact on the optional THS2 connected to the THS2-0MM master: $M01=5$ or $M03=5$, or on the THS2-0MM master $I07=5$ or $I09=5$, or an analogue input is configured as window contact $I11=8$ or $I13=8$, the outputs are all disabled if the window contact is opened.

The icon  flashes when the window contact is considered open.

If an electrical resistance has been activated, the ventilation is stopped after delay $I45$ has elapsed in order to evacuate the calories produced by the electrical resistance. If $I45=0$, a minimum delay of 30 s is applied.

26. Frost protection function of the heating battery

The frost protection function of the heating battery is conducted by means of a regulation sensor.

If a THS2-0MM goes into frost protection mode, the heating outputs and the fan coil speed are forced to maximum.

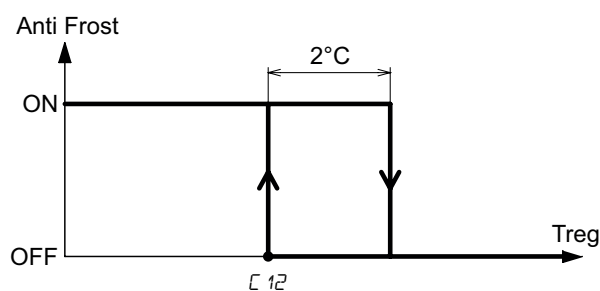



Anti Frost: frost alarm

Treg: regulation sensor

E12: frost protection setpoint

If the $Treg < E12$, the frost protection alarm is activated, the  and  icons flash, and the *RLF* message appears on the alarm page.

If a relay output is configured on a slave with alarm function $I15=14$ (D01) or $I16=14$ (D02) or $I17=14$ (D03) or $I18=14$ (D04) or $I19=14$ (D05) or $I20=14$ (D06), the relay is activated for the duration of the frost protection state.

If $Treg \geq (E12 + 2^{\circ}\text{C})$, the frost protection alarm is deactivated, and the  and  icons turn off.

If a relay output is configured on a slave with alarm function $I15=14$ (D01) or $I16=14$ (D02) or $I17=14$ (D03) or $I18=14$ (D04) or $I19=14$ (D05) or $I20=14$ (D06), the relay is deactivated.

Note: the icons indicated are present on an optional THS2 connected to the THS2-0MM.

If the regulation sensor on a THS2-0MM is in error, the frost protection function on that unit is deactivated.

27. Dirty filter

For each THS2-0MM, the dirty filter function facilitates counting the hours of operation of the connected fan and the issuance of a warning message with the  icon once the count has exceeded the maximum number of hours defined by parameter *IS1*.

In this case, the fan filter is considered clogged and must be changed.

Note: the icon indicated is present on an optional THS2 connected to the THS2-0MM.

To activate the dirty filter function on a slave, set the maximum number of hours to be counted with parameter *IS1* to a value other than 0.

To disable this function, set *IS1*, the maximum number of hours to count, to 0.

With the function activated, the counter for hours of fan operation is stored in memory every 2 hours. To reset the counter of a slave, set parameter *IS3* to 1. The counter is reset, and parameter *IS3* automatically changes to 0, and the icon  stops flashing until the counter exceeds the value of parameter *IS1* again.

Note: With the function deactivated, the hours of fan operation are not counted.

28. Summertime changeover

The unit is designed to automatically change to and from summertime for some areas of the world.

In order to use this function:

- Set parameter *M08* to 1 if the controller is used in the Europe zone,

For all zones other than Europe, set parameter *M08* to 0. Summertime cannot be updated automatically in this case. Update summertime based on information from the country concerned.

29. Remote setpoint variator

On a local THS2-0MM, it is possible to change the setpoint by a shift of $\pm x$ °C from the main setpoint by connecting the SAP-NTC10-02-2-EV setpoint variator to an analogue input configured as a setpoint variator input: $I 11=10$ for AI1 or $I 13=10$ for AI2.

The range of variation $\pm x$ °C is defined by parameter $M 12$.

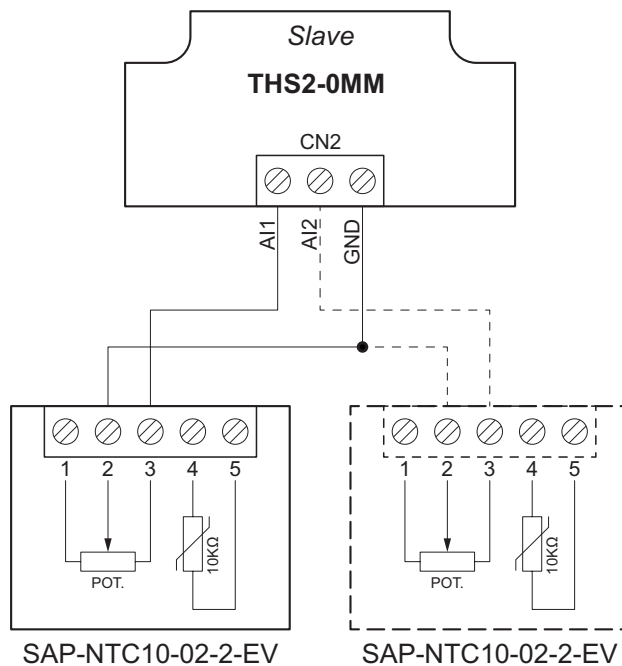

The heating and cooling working setpoint value obtained after changing the remote setpoint can be displayed on the I/O status if an optional THS2 is connected to the THS2-0MM. By Modbus it is possible to see the value of variation of setpoint directly on variable `ADR_MOD_STATUS_CURRENT_OFFSET_VARIATOR` (11032).

30. Restoring default parameters

It is possible to reset all parameters excluded parameters for communication ($M 17$, $M 18$, $M 19$).

Writing the value 1 to variable `ADR_MOD_RESET_PARAM_TO_DEFAULT` (11153) to reset all parameters to default value or press the key SW3 for around 5 s till the red led that is normally flashing stops flashing and remain lit on. Release then the key.

It is possible to reset all parameters included parameters for communication ($M 17$, $M 18$, $M 19$).

Press the key SW3 for around 5 s till the red led that is normally flashing stops flashing and remain lit on.

Continue to maintain pressed the key SW3 for other 5 s till the red led lit off continuously. Release then the key.

31. Optional THS2

The optional THS2 can be connected with each THS2-0MM master or slave of an internal network using connector CN5. If it is connected to a master, it is possible to control all parameters of internal network if $M22=0$ or 1.

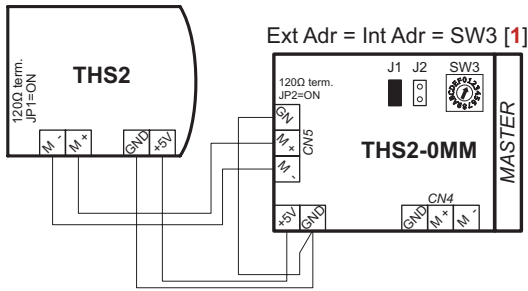

If it is connected to a slave, it is possible to control only few parameters if $M22=0$ or 1:

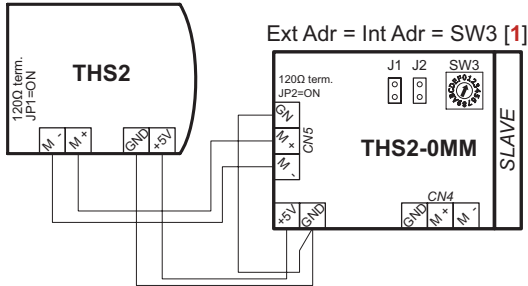

- setpoint,
 - offset setpoint if comfort function is activated,
 - on/off,
 - speed of ventilator,
- Any modification done on these parameters are then transmitted on the whole network by the THS2-0MM master unit.

if THS2 is connected to a THS2-0MM unit the values of internal temperature and humidity of THS2 can be considered for regulation on whole internal network or locally on THS2-0MM unit at which it is connected (see [“6. Regulation sensor” page 13](#)).

THS2 can also be used as a simple visualizer of the THS2-0MM status if $M22=2$.

The first time THS2 is connected it is necessary for THS2 to establish a connection with the address set.



Press the keys + simultaneously, the following message appears on the display:

Press the key the current address is flashing. With keys or select the address (set on rotary switch SW3 if J2 is off

or set on parameter $M19$ if J2 ON) and press the the key to save the selection, then the key to exit connection address setting. If connection is established, the screen displays operating mode.

32. Display, keypad and icons of THS2

	Display B
	On/Off
flashing	Timer extension on
steady on with one flash every 5 seconds	Operation within the time band (normal/eco operation)
steady on	Setting the clock
ECO	Economy operation on
	Alarm condition
	Alarm communication
	Configuration, setpoints or THS2 parameters menu
HEAT COOL	Operating season
	THS2-0MM fan hours of operation exceeded alarm
	Cooling on
flashing	Frost protection on
	Dehumidifier on
	Air exchange on
	Heating on
	Electrical resistance on
	Unoccupied holidays mode
flashing	Window open
	Fan speed M>manual speed selection A=automatic speed selection
OFF ON	Display C Displayed slave number on I/O menu and letter 'C' when communication takes place between THS2 and THS2-0MM.
sequence 1	M>manual speed selection A=automatic speed selection Minimum thermostat trigger, power sequencing 1, 2, 3, 4, 1.
sequence 2	
sequence 3	
sequence 4	
Keypad	
	On/Off key, navigation and confirmation
	Setpoint change, navigation and value change keys
	Speed type key and ESC function in navigation
	Key for manually changing season, task or operating mode (see <i>"MODE key function" page 56</i>)

33. Setting parameters using quick access on THS2

The controller provides the following functions at the touch of a key:

- On/Off switch
- setting the setpoint and offset setpoint
- fan operating mode
- setting the **MODE** key function



It is possible to associate one quick access function and two normal access functions to the **MODE** key, depending on parameter $M07$ (see “*MODE key function*” page 56)



$M07=0$: season changeover (if local, for 2-pipe systems)

$M07=1$: timer extension

$M07=2$: operating mode (without time bands only if $M10=0$, with time bands, unoccupied holidays)

• Keypad lock

To lock the keypad, press the   keys simultaneously; the message *LK* appears on the display for one second. The parameters can no longer be accessed by pressing any key, and the message *LK* appears on the display.

To unlock the keypad, press the   keys again; the message *NLK* appears on the display for one second.

• Global on/off

The unit can be switched on and off in four different ways:

- by external contact **connected on the THS2-0MM master**,
- by time bands (lower priority) if $M10=1$ and $M14=0$,
- manually, using the keypad. To turn the unit on or off manually, press the  key until the message *ON* or *OFF* appears.
- by Modbus via supervisory system (highest priority).

The external contact has the highest priority. When it is used, manual on/off and time bands on/off are not considered.

On/off switching via Modbus has the same priority as manual on/off or time bands on/off. This means that unit can be switched off by supervisor and switch on by time bands or manually (if $M14=0$) or only manually (if $M14=1$).

If unit has been switched off manually it is possible to switch it on by supervisor, manually or by time bands (if $M14=0$).

If unit has been switched off manually it is possible to switch it on by supervisor, or manually (if $M14=1$).

To use the external contact as on or off, set “remote On/Off” on the THS2-0MM master. Configure $I07=2$ (DI1) or $I09=2$ (DI2) or $I11=5$ (AI1 used as remote DI on/off) or $I13=5$ (AI2 used as remote DI on/off) using an optional THS2 connected to it or write the corresponding address (see “*52. THS2-0MM master Modbus variables*” page 90). For instance to configure $I07=2$ write the value 2 in address **ADR_MOD_DIGINPUT1FUN** (11075).

To switch on and off from time bands, configure parameter $M10=1$, and set the time bands for switch-on (see “*36. Operation and setting of TIME BANDS*” page 60).

To switch on and off via Modbus write 0 or 1 on variable **ADR_MOD_FORCE_MASTERGLOBALONOFF** (11048).

If the unit is switched off, the display shows how it was switched off.

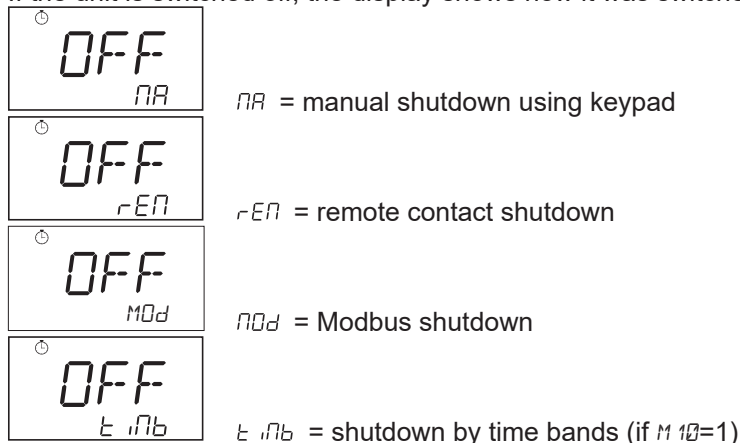





If the unit is switched off, all outputs except the main regulation output in heating mode are deactivated when the frost protection heating function (see “*26. Frost protection function of the heating battery*” page 49) is triggered.



• Setting the setpoint and offset setpoint

For 2-pipe regulation, the main setpoint is $C01$ in heating mode and $C02$ in cooling mode.

For 4-pipe regulation, the main setpoint is $C03$.

The setpoint can be changed on the THS2 unit by pressing the keys  or  if $M11=0$. The “set” icon flashes while the setpoint is being changed.



If $M11=1$ (active COMFORT mode used when the application needs to set a setpoint that is not accessible to the user) a change of $\pm x$ °C from the setpoint can be set by pressing the  key or the  key; the “C” icon flashes. The setpoint can then only be changed by accessing the setpoint parameters using password 22. The maximum setpoint variation for $\pm x$ °C is defined by parameter $M12$.

Each change made with the  or  keys is saved automatically.

It is possible to change the setpoint locally on a slave by a shift of $\pm x$ °C from the main setpoint by connecting the SAP-NTC10-02-2-EV setpoint variator to an analogue input configured as a setpoint variator input: $I11=10$ for AI1 or $I13=10$ for AI2.

To exit the setpoint setting menu, wait 4 seconds or press the  key.

• Fan operating mode

Press the  key; the  icon flashes along with the operating mode indicator of the fan coil unit on display B.

Press the  key one or more times to select the operating mode of the fan coil unit:

 A $RULED$ = automatic regulation,

 M $SPE1$ = regulation at speed 1,



 M $SPE2$ = regulation at speed 2,

 M $SPE3$ = regulation at speed 3,

The value is saved automatically.

To exit the menu, wait 4 seconds until display B stops flashing.



• MODE key function

The quick access function is selected by pressing the MODE key based on the value of parameter $M07$. The other 2 functions can still be accessed by pressing the   keys.

Access the quick function with the MODE key:



- If $M07=0$ (quick access to local season changeover setting, if no contact is configured as remote season changeover on master and slave units)

Press the  key; the “HEAT” (for heating) or “COOL” (for cooling) icon flashes according to the current setting, and the same flashing message appears on display B.

Press the  key to change the setting. The value is saved automatically. To exit the menu, wait 4 seconds or press the  key.

- If $M07=1$ (quick access to timer extension setting)

The timer extension function extends operation with the base setpoint, excluding the economy function and the “unoccupied holidays” function, for a time corresponding to parameter $M09$ if the time band function parameter $M10=0$. With $M10=1$ (time bands for switching on and off), the timer extension function extends the ON operation by excluding the bands for a time corresponding to parameter $M09$.

Press the  key; the message $no\overline{off}$ flashes on display B (to stop the timer extension, if it has started) or the message \overline{off} on display B and the  icon flashes (to activate the timer extension).

Press the  key to change the setting. The value is saved automatically.

To exit the menu, wait 4 seconds or press the  key.

- If $M07=2$ (quick access to operation mode setting)

The operating mode function allows for the selection of regulation either with or without time bands (if the parameter $M10=0$, regulation is with time bands, see “[36. Operation and setting of TIME BANDS](#)” page 60) or in “unoccupied holidays” mode (see “[10. Working setpoint, economy and unoccupied holidays mode](#)” page 21).

If $M10=0$, time band function for normal/economy operation:

press the  key; the following message flashes:

$no\overline{off}$ on display B (to regulate without time bands) or

\overline{off} on display B and the  icon (to regulate with normal/economy time bands) or

$HOLY$ on display B and the  icon (to regulate in “unoccupied holidays” mode).

If $M10=1$, time band function for switching the unit off and on:

press the  key; the following message flashes:



$no\overline{off}$ on display B (to regulate with time bands) or

$HOLY$ on display B and the  icon (to regulate in “unoccupied holidays” mode).

Press the  key one or more times to select the regulation mode. The value is saved automatically.

To exit the menu, wait 4 seconds or press the  key.

Access to non-quick functions with the   keys:

- If the quick access function of the **MODE** key is set to local season changeover ($M10=0$), to access the other functions, press the  and  keys simultaneously to enter the menu for modifying the timer extension and operating mode functions:



Parameter	Description	Default	Min	Max
<i>M0C</i>	Timer extension <i>n00C</i> =without timer extension <i>0C</i> =with timer extension (for the duration corresponding to parameter <i>M09</i>): -The economy function and the unoccupied holidays function are excluded if $M10=0$. - The unit stays on, if $M10=1$.	<i>n00C</i>	<i>n00C</i>	<i>0C</i>
<i>M0d</i>	Operating mode with $M10=0$: <i>n0rN</i> =operation without time bands <i>t n b</i> =operation with time bands <i>HOLY</i> =unoccupied holidays operation	<i>n0rN</i>	<i>n0rN t n b HOLY</i>	
	Operating mode with $M10=1$: <i>n0rN</i> =time band mode <i>HOLY</i> =unoccupied holidays operation	<i>n0rN</i>	<i>n0rN HOLY</i>	



Press the  or  key to select a parameter and the  key to enter edit mode; display B flashes with the current value of the parameter.

Press the  or  key to change the setting.

Press the  key to save the settings, or the  key to exit without saving the changes.



To exit the menu, press the  key again or wait approximately 10 seconds.

If the timer extension function is on, the  icon flashes for the duration of parameter *M09*.
 If the timer extension function has been turned off, the  icon is off.

- If the quick access function of the **MODE** key is set to timer extension ($M10=1$), to access the other functions, press the  and  keys simultaneously to enter the menu for modifying the operating mode and season changeover functions:



Parameter	Description	Default	Min	Max
<i>SEa</i>	Local season changeover (local season changeover setting for 2-pipe systems): <i>HEaT</i> =heating mode <i>COOL</i> =cooling mode	<i>HEaT</i>	<i>HEaT</i>	<i>COOL</i>
<i>M0d</i>	Operating mode with $M10=0$: <i>n0rN</i> =operation without time bands <i>t n b</i> =operation with time bands <i>HOLY</i> =unoccupied holidays operation	<i>n0rN</i>	<i>n0rN t n b HOLY</i>	
	Operating mode with $M10=1$: <i>n0rN</i> =time band mode <i>HOLY</i> =unoccupied holidays operation	<i>n0rN</i>	<i>n0rN HOLY</i>	

Press the  or  key to select a parameter and the  key to enter edit mode; display B flashes with the current value of the parameter.

Press the  or  key to change the setting.

Press the  key to save the settings, or the  key to exit without saving the changes.

To exit the menu, press the  key again or wait approximately 10 seconds.

- If the quick access function of the **MODE** key is set to operating mode ($M07=2$), to access the other functions, press the  and  keys simultaneously to enter the menu for modifying the season changeover and timer extension functions:

Parameter	Description	Default	Min	Max
SEB	Local season changeover (local season changeover setting for 2-pipe systems): HEAT=heating mode COOL=cooling mode	HEAT	HEAT	COOL
M0C	Timer extension noDC=without timer extension DC=with timer extension (for the duration corresponding to parameter M09): - The economy function and the unoccupied holidays function are excluded, if $M10=0$. - The unit stays on, if $M10=1$.	noDC	noDC	DC

Press the  or  key to select a parameter and the  key to enter edit mode; display B flashes with the current value of the parameter.

Press the  or  key to change the setting.

Press the  key to save the settings, or the  key to exit without saving the changes.

To exit the menu, press the  key again or wait approximately 10 seconds.

34. Timer extension or forced presence mode

This function can only be used using a THS2 connected to a THS2-0MM master in the internal network.

If time bands are used for the “energy saving” function ($M10=0$) when the “energy saving” or “unoccupied holidays” function is used, the working setpoints are calculated taking parameters $C0B$ (economy offset) and $C09$ (“unoccupied holidays” operating mode offset) into account.

These functions can be bypassed while continuing regulation with the basic setpoints for a specified time (parameter $M09$).

To bypass these functions, set the timer extension manually using the MODE key (see “33. Setting parameters using quick access on THS2” page 54).

If, on the other hand, time bands are used to switch the unit on or off $M10=1$, if the timer extension function is activated by the MODE key, the unit does not take the time bands into account and keeps the unit on for the time corresponding to parameter $M09$, if the extension function has been set using the keypad. To activate the timer extension function manually, set parameter

$M0C$ to DC (see “MODE key function” page 56). Once activated, the time defined by parameter $M09$ elapses before returning to normal operation.

If the timer extension function is on, the  icon flashes for the duration of parameter $M09$.

If the timer extension function has been turned off, the  icon is off.

35. Setting DATE and TIME

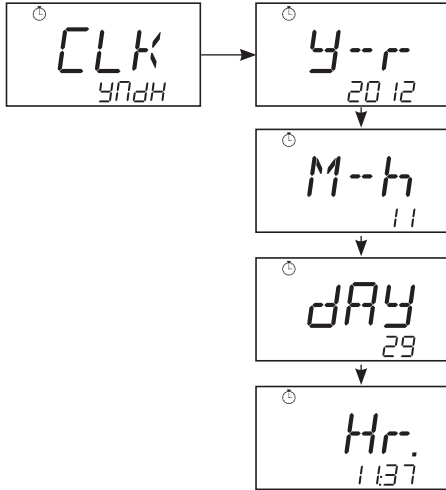

Press the and keys simultaneously.

The message *CLK* appears on display A and *Yr dH* on display B.

Press the key to enter the date and time setting menu.

Parameter	Description	Min	Max
<i>CLK</i>	Date and time setting menu		
<i>Y-r</i>	Year	2012	2100
<i>M-h</i>	Month	1	12
<i>dAY</i>	Day	1	31
<i>Hr.</i>	Hours	0	23
	Minutes	0	59

Press the or key to select a parameter to modify and the key to enter edit mode; display B flashes with the current value of the parameter.

Press the or key to change the setting.

Press the key to save the settings or the key to exit without saving the changes.



To exit the menu, press the key again or wait approximately 120 seconds.

Note: by setting parameter *MOB*=1 for the Europe zone, the unit is able to update summertime automatically. If parameter *MOB*=0 (other zones), the summertime update is disabled.

36. Operation and setting of TIME BANDS

Based on parameter $M10$, the time bands can be assigned to normal/economy regulation ($M10=0$) or to switching the unit on or off ($M10=1$).

A maximum of 4 bands can be used per day.

- With $M10=0$ within an ON band, regulation is normal, i.e. it is done with the basic setpoints; the  icon remains steadily lit and flashes briefly every 5 seconds. Outside the ON band, the controller works in economy mode, and (see ["10. Working setpoint, economy and unoccupied holidays mode"](#) page 21) the  icon is off, and the ECO icon is on.

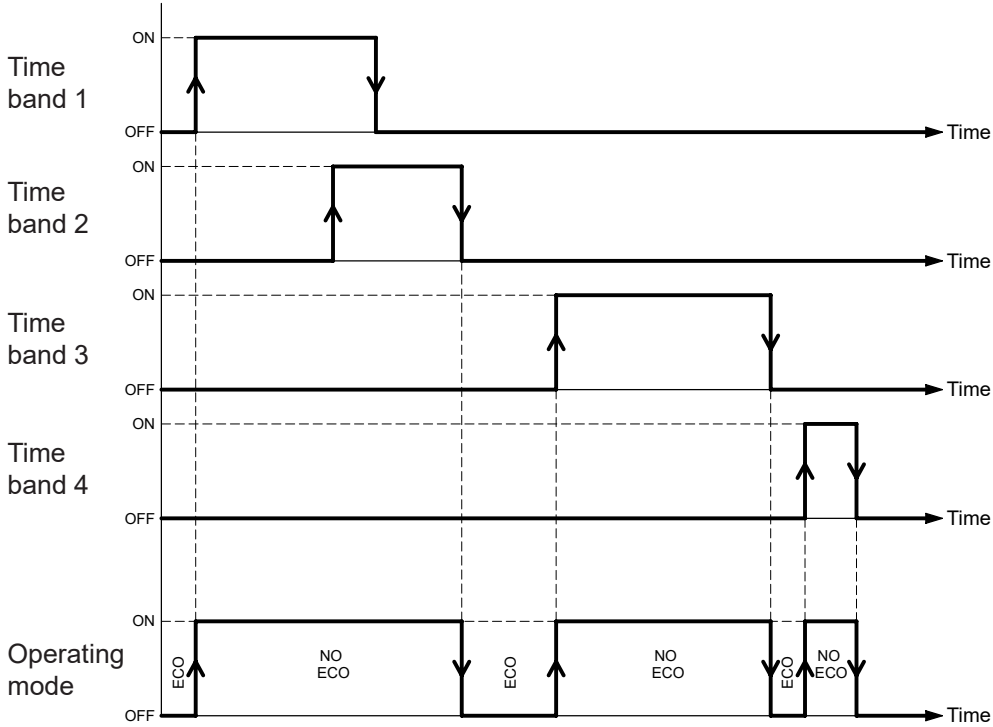

ECO=economy mode, **NO ECO**=normal mode (regulation with basic setpoint).

- With $M10=1$ within an ON band, the unit is on. Outside the ON band, the controller is off and is activated only by the frost protection function.

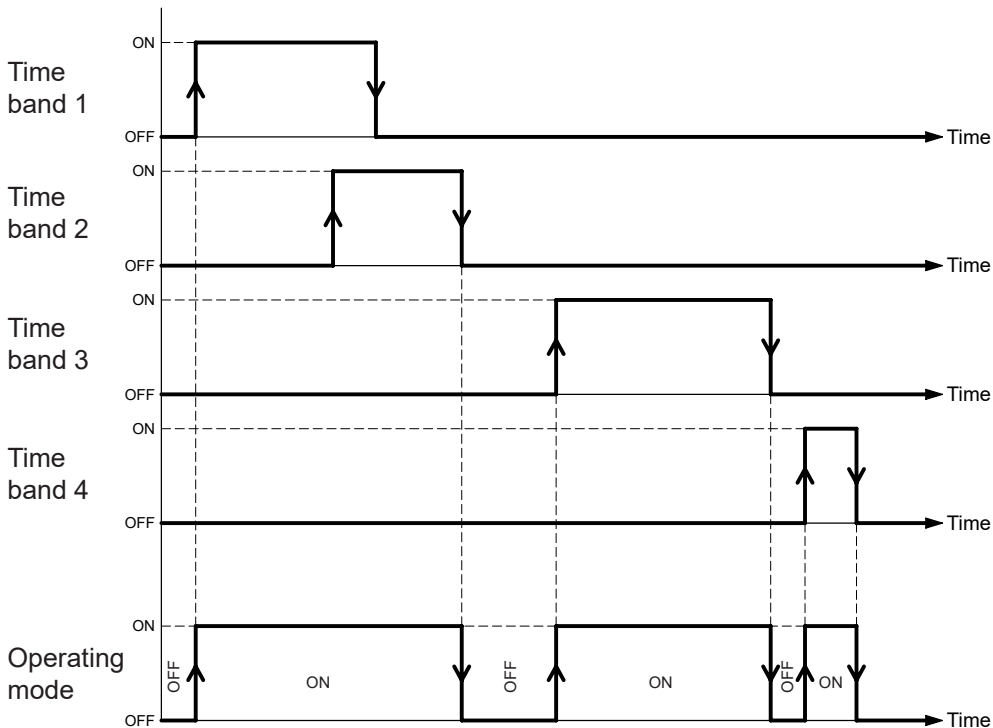

OFF=unit off, **ON**=unit on.

To operate with a time band, set the start time (ON) and end time (OFF).

If the start time (ON) is simultaneously as or earlier than the end time (OFF), the corresponding time band is excluded.

If two time bands overlap, the first time is considered as the beginning of the band, and the last time as the end of the band.

To edit a time band, follow the procedure below.

Press the  and  keys simultaneously; the main menu screen appears.





Press the  key; the following screen appears:



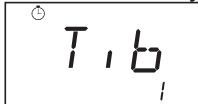

Press the  key; the screen with the flashing digit 1 corresponding to band 1 appears:



Press the  or  key to select the band to be changed.



Press the  key; the screen indicating the flashing day of the band appears:





Press the  or  key to select the desired day.

Press the  key; the screen indicating the day, band number, and the flashing start time (ON) appears with hours flashing:



Press the  or  key to select the desired time.



Press the  key; the start hour time of the band stops flashing, is saved in memory, and the minute range of the selected band's start time flashes.

Press the  or  key to select the desired minutes.



Press the  key; the minutes of the band's start time stop flashing and are saved in memory.

The screen for setting the end time of the respective band appears, with hours flashing:



Press the  or  key to select the hours end time.

Press the  key; the hours end time of the band stops flashing, is saved in memory, and the minute range of the selected band's end time flashes.

Press the  or  key to select the desired minutes.

Press the  key; the minutes of the band's end time stop flashing and are saved in memory.

The flashing screen for selecting the day of the band appears.

Press the  key to go back to the band selection menu:

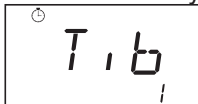

Press the  key to go back to the main menu, or repeat the procedure to set another band.

Parameter	Description	Min	Max
WPR	Operation and setting of time bands		
T, b	Band selection	1	4
X	Day of the week Mon=Monday; Tue=Tuesday; Wed=Wednesday; Thu=Thursday; Fri=Friday; Sat=Saturday; Sun=Sunday	Mon	Sun



38. Alarms

The alarms facilitate detection of one or more abnormal conditions during the operation of the controller. Multiple alarms can be viewed by accessing the dedicated alarm pages.

To access the alarm page, proceed as follows:

Press the  and  keys simultaneously to access the general menu. The following screen appears:



Use the  or  key until the following screen appears:















Press the  key to access the alarm pages.



The alarm page is shown on display A, and an alarm message is indicated on display B (see table below) or if there is no alarm, the message *noAL* appears.

Press the  key to display any multiple alarms that may be present. Press the  key to go back in the list of alarms.

Alarms table

Message	Alarm type	Activity on the regulation	Flashing icons
<i>noAL</i>	No alarm_	-	-
<i>CM</i>	Communication timeout between THS2 and THS2-0MM	After 10 minutes outputs are deactivated in case of continuous error	  485
<i>CMd</i>	Incorrect data or routing between THS2 and THS2-0MM	After 10 minutes outputs are deactivated in case of continuous error	  485
<i>ALFx</i>	Frost protection THS2-0MM * * : 1, 2, 3, 4, 5, 6, 7, 8, 9, A, B, C, D, E, F	Fan coil at maximum speed Heating valve at maximum opening Cooling valve closed	 
<i>r * A 1</i>	Sensor AI1 of THS2-0MM * * : 1, 2, 3, 4, 5, 6, 7, 8, 9, A, B, C, D, E, F	Outputs regulated based on that sensor are deactivated	
<i>r * A 2</i>	Sensor AI2 of THS2-0MM * * : 1, 2, 3, 4, 5, 6, 7, 8, 9, A, B, C, D, E, F	Outputs regulated based on that sensor are deactivated	
<i>A * Y Y</i>	Contact alarm THS2-0MM * * : 1, 2, 3, 4, 5, 6, 7, 8, 9, A, B, C, D, E, F YY: error code (see below)	Visual indication and any relay activation configured as alarm on the slave in alarm	
<i>A n Y Y</i>	Contact alarm THS2. * : 1, 2, 3, 4, 5, 6, 7, 8, 9, A, B, C, D, E, F YY: error code (see below)	Visual indication	
<i>n H u</i>	Error reading internal humidity sensor of the THS2	Visual indication	
<i>F i L x</i>	Filter of fan coil unit connected to THS2-0MM * dirty * : 1, 2, 3, 4, 5, 6, 7, 8, 9, A, B, C, D, E, F	Visual indication	 
<i>ECL</i>	Clock error reading on THS2	Indication only, no effect on regulation	

THS2-0MM *: THS2-0MM with internal address from 1 to 9, A(10), b(11), C(12), d(13), E(14), F(15).

If the sensors used for regulation are faulty (open or short-circuited), the valve outputs, electrical resistances and/or fan coil unit are deactivated,
If parameter *M05* or *M06* is set so that the working setpoint of the slave in question is shown on the corresponding display, if the operating temperature cannot be determined (open or short-circuited sensor), "----" is shown on the display.

If the temperature sensor displayed on display A is in alarm, the following screen appears if the sensor is open:

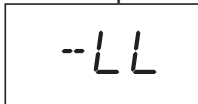

or

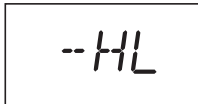

if the sensor is short-circuited.

The error code *yy* present in the alarm contact alarm message is defined as below:

Fixed part=0	Value for each digital or analogue input set as alarm contact and on alarm position to be added to the fixed part to obtain error code <i>yy</i>			
	AI2	AI1	DI2	DI1
	8	4	2	1

Example: if DI2 and AI1 are used as alarm contact on THS2-0MM with internal address 3: $I_{09}=6$, $I_{11}=9$,

if DI2 is on alarm position alone $yy=2$, alarm message is A302,

if AI1 is on alarm position alone $yy=4$, alarm message is A304,

if DI2 and AI1 are both in alarm position $yy=6$, alarm message is A306.

If a digital output of a slave is configured with alarm function $I_{15}=14$ or $I_{16}=14$ or $I_{17}=14$ or $I_{18}=14$ or $I_{19}=14$ or $I_{20}=14$, the latter is activated if the same slave has a digital input configured as alarm $I_{07}=6$ or $I_{09}=6$ or a sensor input configured as alarm contact $I_{11}=9$ or $I_{13}=9$ in alarm position.

In the event of a frost protection alarm, the relay is also activated as long as the frost protection condition remains.

Note: If a THS2-0MM fails to communicate with the THS2, the letter *E* flashes on the display along with the icons 485:



It is possible to monitor the communication status between the master and any slave and between the master and any transmitter of the internal network by accessing the error counter parameters under password 66 (see below).

• Communication error counter parameters

The communication error counter parameters of the internal network can be accessed with a password.

Press the and keys simultaneously to access the general menu. The following screen appears:



Press the or key until the following screen appears:



Press the key and then the key until the value **66** is displayed.

Press the key to access level of communication error counter parameters. The screen corresponding to the first parameter of this level appears:

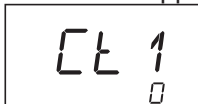



Use the or key to scroll through the error counter parameters.

Parameter	Description	Default	Min	Max
CLU	Communication timeout counter between THS2 and THS2-0MM connected	0	0	9999
CrU	Date error counter or incorrect routing message counter between THS2 and THS2-0MM connected	0	0	9999



Parameter	Description	Default	Min	Max
CL1	Communication timeout counter between master and slave 1	0	0	9999
Cr1	Date error or incorrect routing message counter between master and slave 1	0	0	9999
CL2	Communication timeout counter between master and slave 2	0	0	9999
Cr2	Date error or incorrect routing message counter between master and slave 2	0	0	9999
CL3	Communication timeout counter between master and slave 3	0	0	9999
Cr3	Date error or incorrect routing message counter between master and slave 3	0	0	9999
CL4	Communication timeout counter between master and slave 4	0	0	9999
Cr4	Date error or incorrect routing message counter between master and slave 4	0	0	9999
CL5	Communication timeout counter between master and slave 5	0	0	9999
Cr5	Date error or incorrect routing message counter between master and slave 5	0	0	9999
CL6	Communication timeout counter between master and slave 6	0	0	9999
Cr6	Date error or incorrect routing message counter between master and slave 6	0	0	9999
CL7	Communication timeout counter between master and slave 7	0	0	9999
Cr7	Date error or incorrect routing message counter between master and slave 7	0	0	9999
CL8	Communication timeout counter between master and slave 8	0	0	9999
Cr8	Date error or incorrect routing message counter between master and slave 8	0	0	9999
CL9	Communication timeout counter between master and slave 9	0	0	9999
Cr9	Date error or incorrect routing message counter between master and slave 9	0	0	9999
CLA	Communication timeout counter between master and slave 10	0	0	9999
CrA	Date error or incorrect routing message counter between master and slave 10	0	0	9999
CLb	Communication timeout counter between master and slave 11	0	0	9999
Crb	Date error or incorrect routing message counter between master and slave 11	0	0	9999
CLc	Communication timeout counter between master and slave 12	0	0	9999
CrC	Date error or incorrect routing message counter between master and slave 12	0	0	9999
CLd	Communication timeout counter between master and slave 13	0	0	9999
Cr-d	Date error or incorrect routing message counter between master and slave 13	0	0	9999
CLE	Communication timeout counter between master and slave 14	0	0	9999
Cr-E	Date error or incorrect routing message counter between master and slave 14	0	0	9999
CLF	Communication timeout counter between master and slave 15	0	0	9999
Cr-F	Date error or incorrect routing message counter between master and slave 15	0	0	9999
CLL	Communication timeout counter between master and transmitter TCO2A(-D)-M or TUA(-D)-M	0	0	9999
CrL	Date error counter or incorrect routing message counter between master and transmitter TCO2A(-D)-M or TUA(-D)-M	0	0	9999

• Resetting of internal network communication error counter parameters

To reset all error counters of internal network communication (parameters from CLU to CrL) follow the procedure below.

Press the  and  keys simultaneously to access the general menu. The following screen appears:



Press the  or  key until the following screen appears:







Press the  key and then the  key until the value **67** is displayed.



Press the  key to access the reset level for internal network communication error counters





To cancel and return to regulation, press the  key.

To start the procedure, press the  key; the value 0 flashes. Press the  key to set the value to 1, and then press the  key again. When the procedure finishes, the value set returns to 0. It is possible to exit the menu by pressing the  key once or waiting approximately 120 seconds.

39. Setting configuration parameters (level 1 password)

The configuration parameters on a THS2 connected to THS2-0MM master are password-protected. Any modification done on parameters are transferred to the THS2-0MM after exiting the configuration parameters menu. Press the  and  keys simultaneously to access the general menu. The following screen appears:



Press the  or  key until the following screen appears:

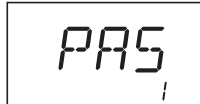

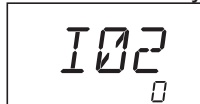

Press the  key and then the  key until the value **11** is displayed.

Press the  key to access level 1. The screen corresponding to the first parameter of level 1 appears:



Use the  or  key to scroll through the parameters.

To change a parameter, press the  key and then the  or  key to select its value.

Press the  key to save the value, or the  key to exit parameter modification without saving the changes.

To exit the menu, press the  key one or more times or wait approximately 120 seconds.

Parameter	Description	Default	Min	Max
I01	Type of system 0=2-pipe 1=4-pipe	0	0	1
I02	Type of sensor for regulation 0=regulation with own remote sensor (I11=1 or I13=1) 1=regulation with supervisor temperature or internal temperature of THS2 unit [in ADR_MOD_STATUS_CURRENT_THS2_TEMP (11034) must be written the value of temperature in case of supervisor temperature] 2=regulation with remote regulation sensor of master unit of internal network	0	0	2
I03	Type of heating battery (stage 1), 0=no heating battery 1=modulating electrical resistance 2=modulating valve 3=on/off electrical resistance 4=on/off or 3-point valve	4	0	4
I04	Type of cooling battery 0=no cooling battery 1=modulating valve 2=on/off or 3-point valve	2	0	2
I05	Type of supplemental battery (stage 2 heating or for mid-season operation) 0=no supplemental battery 1=on/off electrical resistance 2=modulating electrical resistance	0	0	2
I06	Fan type 0=fan coil unit not operated 1=three-speed on/off fan coil unit 2=modulating fan coil unit	1	0	2
I07	Function of digital input 1 0=not used 1=remote season changeover (INPUT ON=winter, INPUT OFF=summer) 2=remote On/Off (INPUT ON=OFF, INPUT OFF=ON) 3=unoccupied holidays (INPUT ON=occupied) 4=economy (INPUT ON=economy active) 5>window contact (INPUT OFF=window open) 6=alarm (INPUT ON=alarm occurrence) 7=minimum thermostat contact, fan coil unit battery fluid (INPUT ON=thermostat closed)	0	0	7

Parameter	Description	Default	Min	Max
I 08	Digital input 1 contact logic 0=normally open (open=INPUT OFF, closed=INPUT ON) 1=normally closed (closed=INPUT OFF, open=INPUT ON)	0	0	1
I 09	Function of digital input 2 0=not used 1=remote season changeover (INPUT ON=winter, INPUT OFF=summer) 2=remote On/Off (INPUT ON=OFF, INPUT OFF=ON) 3=unoccupied holidays (INPUT ON=occupied) 4=economy (INPUT ON=economy active) 5=window contact (INPUT OFF=window open) 6=alarm (INPUT ON=alarm occurrence) 7=minimum thermostat contact, fan coil unit battery fluid (INPUT ON=thermostat closed)	0	0	7
I 10	Digital input 2 contact logic 0=normally open (open=INPUT OFF, closed=INPUT ON) 1=normally closed (closed=INPUT OFF, open=INPUT ON)	0	0	1
I 11	Function of analogue input 1 0=not used 1=remote regulation sensor 2=water sensor for automatic season changeover 3=minimum thermostat sensor (fan coil unit battery fluid) 4=remote contact for season changeover (INPUT ON=winter, INPUT OFF=summer) 5=remote on/off (INPUT ON=OFF, INPUT OFF=ON) 6=unoccupied holidays (INPUT ON=occupied) 7=economy (INPUT ON=economy active) 8=window contact (INPUT OFF=window open) 9=alarm (INPUT ON=alarm occurrence) 10=remote setpoint variator	1	0	10
I 12	Analogue input logic 1 (only with I 11=4 to 9) 0=normally open (open=INPUT OFF, closed=INPUT ON) 1=normally closed (closed=INPUT OFF, open=INPUT ON)	0	0	1
I 13	Function of analogue input 2 0=not used 1=remote regulation sensor 2=water sensor for automatic season changeover 3=minimum thermostat sensor (fan coil unit battery fluid) 4=remote contact for season changeover (INPUT ON=winter, INPUT OFF=summer) 5=remote on/off (INPUT ON=OFF, INPUT OFF=ON) 6=unoccupied holidays (INPUT ON=occupied) 7=economy (INPUT ON=economy active) 8=window contact (INPUT OFF=window open) 9=alarm (INPUT ON=alarm occurrence) 10=remote setpoint variator	0	0	10
I 14	Analogue input logic 2 (only with I 13=4 to 9) 0=normally open (open=INPUT OFF, closed=INPUT ON) 1=normally closed (closed=INPUT OFF, open=INPUT ON)	0	0	1
I 15	Digital output mode 1 0=not used 1=on/off fan speed 1 2=on/off fan speed 2 3=on/off fan speed 3 4=heating valve 5=cooling valve 6=mixed-use valve 7=electrical resistance stage 1 8=electrical resistance stage 2 or for mid-season 9=relay for EC motor 10=pump 11=CO ₂ damper 12=dehumidifier based on internal humidity sensor of THS2 13=dehumidifier based on remote humidity value of transmitter connected to internal network 14=alarm 15=3-point heating valve: opening 16=3-point heating valve: closure 17=3-point cooling valve: opening 18=3-point cooling valve: closure 19=3-point mixed-use valve: opening 20=3-point mixed-use valve: closure	1	0	20

Parameter	Description	Default	Min	Max
I 16	Digital output mode 2 0=not used 1=on/off fan speed 1 2=on/off fan speed 2 3=on/off fan speed 3 4=heating valve 5=cooling valve 6=mixed-use valve 7=electrical resistance stage 1 8=electrical resistance stage 2 or for mid-season 9=relay for EC motor 10=pump 11=CO ₂ damper 12=dehumidifier based on internal humidity sensor of THS2 13=dehumidifier based on remote humidity value of transmitter connected to internal network 14=alarm 15=3-point heating valve: opening 16=3-point heating valve: closure 17=3-point cooling valve: opening 18=3-point cooling valve: closure 19=3-point mixed-use valve: opening 20=3-point mixed-use valve: closure	2	0	20
I 17	Digital output mode 3 0=not used 1=on/off fan speed 1 2=on/off fan speed 2 3=on/off fan speed 3 4=heating valve 5=cooling valve 6=mixed-use valve 7=electrical resistance stage 1 8=electrical resistance stage 2 or for mid-season 9=relay for EC motor 10=pump 11=CO ₂ damper 12=dehumidifier based on internal humidity sensor of THS2 13=dehumidifier based on remote humidity value of transmitter connected to internal network 14=alarm 15=3-point heating valve: opening 16=3-point heating valve: closure 17=3-point cooling valve: opening 18=3-point cooling valve: closure 19=3-point mixed-use valve: opening 20=3-point mixed-use valve: closure	3	0	20
I 18	Digital output mode 4 0=not used 1=on/off fan speed 1 2=on/off fan speed 2 3=on/off fan speed 3 4=heating valve 5=cooling valve 6=mixed-use valve 7=electrical resistance stage 1 8=electrical resistance stage 2 or for mid-season 9=relay for EC motor 10=pump 11=CO ₂ damper 12=dehumidifier based on internal humidity sensor of THS2 13=dehumidifier based on remote humidity value of transmitter connected to internal network 14=alarm	0	0	14

Parameter	Description	Default	Min	Max
I 19	Digital output mode 5 0=not used 1=on/off fan speed 1 2=on/off fan speed 2 3=on/off fan speed 3 4=heating valve 5=cooling valve 6=mixed-use valve 7=electrical resistance stage 1 8=electrical resistance stage 2 or for mid-season 9=relay for EC motor 10=pump 11=CO ₂ damper 12=dehumidifier based on internal humidity sensor of THS2 13=dehumidifier based on remote humidity value of transmitter connected to internal network 14=alarm 15=3-point heating valve: opening 16=3-point heating valve: closure 17=3-point cooling valve: opening 18=3-point cooling valve: closure 19=3-point mixed-use valve: opening 20=3-point mixed-use valve: closure	6	0	20
I 20	Digital output mode 6 0=not used 1=on/off fan speed 1 2=on/off fan speed 2 3=on/off fan speed 3 4=heating valve 5=cooling valve 6=mixed-use valve 7=electrical resistance stage 1 8=electrical resistance stage 2 or for mid-season 9=relay for EC motor 10=pump 11=CO ₂ damper 12=dehumidifier based on internal humidity sensor of THS2 13=dehumidifier based on remote humidity value of transmitter connected to internal network 14=alarm 15=3-point heating valve: opening 16=3-point heating valve: closure 17=3-point cooling valve: opening 18=3-point cooling valve: closure 19=3-point mixed-use valve: opening 20=3-point mixed-use valve: closure	0	0	20
I 21	Analogue output mode 1 0=not used 1=EC fan output 2=heating valve output for 2-pipe or 4-pipe systems 3=cooling valve output for 2-pipe or 4-pipe systems 4=mixed-use valve output for 2-pipe systems 5=modulating CO ₂ damper output 6=modulating dehumidifier based on internal humidity sensor of THS2 7=modulating dehumidifier based on humidity transmitter connected to internal network 8=stage 1 modulating electrical resistance 9=stage 2 or mid-season modulating electrical resistance	0	0	9
I 22	Analogue output mode 2 0=not used 1=EC fan output 2=heating valve output for 2-pipe or 4-pipe systems 3=cooling valve output for 2-pipe or 4-pipe systems 4=mixed-use valve output for 2-pipe systems 5=modulating CO ₂ damper output 6=modulating dehumidifier based on internal humidity sensor of THS2 7=modulating dehumidifier based on humidity transmitter connected to internal network 8=stage 1 modulating electrical resistance 9=stage 2 or mid-season modulating electrical resistance	0	0	9

Parameter	Description	Default	Min	Max
<i>I23</i>	Analogue output mode 3 0=not used 1=EC fan output 2=heating valve output for 2-pipe or 4-pipe systems 3=cooling valve output for 2-pipe or 4-pipe systems 4=mixed-use valve output for 2-pipe systems 5=modulating CO ₂ damper output 6=modulating dehumidifier based on internal humidity sensor of THS2 7=modulating dehumidifier based on humidity transmitter connected to internal network 8=stage 1 modulating electrical resistance 9=stage 2 or mid-season modulating electrical resistance	0	0	9
<i>I24</i>	Sensor AI1 temperature correction (°C) Correction parameter <i>I24</i> is added to the temperature read by remote sensor AI1	0	-5.0	5.0
<i>I25</i>	Sensor AI2 temperature correction (°C) Correction parameter <i>I25</i> is added to the temperature read by remote sensor AI2	0	-5.0	5.0
<i>I26</i>	Weighting (%) of the remote control sensor of THS2-0MM compared to the internal sensor of the THS2 unit or supervisor sensor to form the regulation sensor (<i>I26</i> =0 or 2) <i>I26</i> =0 → internal sensor of the THS2 unit or supervisor sensor used as regulation sensor <i>I26</i> =100 → remote sensor used as regulation sensor <i>I26</i> =Y → remote sensor (TA1) and internal sensor of the THS2 unit or supervisor sensor (Ti) used in combination to form the regulation sensor. The following formula is applied: Treg=[Ti (100 - Y) + (TA1 x Y)] / 100 Sensor AI1 or AI2 must be configured as remote regulation sensors; otherwise parameter <i>I26</i> is not taken into account.	100	0	100
<i>I27</i>	Heating regulation proportional band (°C)	2.0	1.0	5.0
<i>I28</i>	Integral heating regulation time (s). Parameter can be used to regulate 0..10 V modulating valve If <i>I28</i> =0, integral action is excluded.	0	0	999
<i>I29</i>	Cooling regulation proportional band (°C)	2.0	1.0	5.0
<i>I30</i>	Integral cooling regulation time (s). Parameter can be used to regulate 0..10 V modulating valve If <i>I30</i> =0, integral action is excluded.	0	0	999
<i>I31</i>	Hysteresis for on/off heating output (°C)	1.0	0.2	2.0
<i>I32</i>	Hysteresis for on/off cooling output (°C)	1.0	0.2	2.0
<i>I33</i>	Differential between stages (°C)	2.0	0.0	3.0
<i>I34</i>	On/off speed hysteresis (°C) Defines the hysteresis between activation and deactivation of the same speed	0.2	0.2	2.0
<i>I35</i>	Differential between on/off speed 1.2 (°C) Defines the hysteresis between the activation of speeds 1 and 2	0.2	0.2	2.0
<i>I36</i>	Differential between on/off speed 2.3 (°C) Defines the hysteresis between the activation of speeds 2 and 3	0.2	0.2	2.0
<i>I37</i>	Minimum EC motor starting voltage (see ventilation operation)	0.0	0	<i>I38</i>
<i>I38</i>	Maximum voltage applicable to EC motor (see ventilation operation)	10.0	<i>I37</i>	10.0
<i>I39</i>	EC motor starting point during regulation (% valve regulation) Speed 1 activation threshold, EC or 3-speed motor with modulating regulation. Allows the fan to start, only if the valve has reached a minimum percentage opening that is equal to parameter <i>I39</i> (see ventilation operation)	10	0	100
<i>I40</i>	EC fan coil unit proportional band (°C)	2.0	1.0	4.0
<i>I41</i>	EC motor speed 1 (% of range <i>I38</i> - <i>I37</i>) 0% corresponds to <i>I37</i> 100% corresponds to <i>I38</i> (see ventilation operation)	10	0	100
<i>I42</i>	EC motor speed 2 (% of range <i>I38</i> - <i>I37</i>) Speed 2 activation threshold, EC or 3-speed motor, with modulating regulation 0% corresponds to <i>I37</i> 100% corresponds to <i>I38</i> (see ventilation operation)	65	0	100
<i>I43</i>	EC motor speed 3 (% of range <i>I38</i> - <i>I37</i>) Speed 3 activation threshold, EC or 3-speed motor, with modulating regulation 0% corresponds to <i>I37</i> 100% corresponds to <i>I38</i> (see ventilation operation)	100	0	100
<i>I44</i>	Fan start delay from valve opening(s) Facilitates the prevention of annoying ventilation (too cold in winter or too hot in summer) by allowing the battery to warm up or cool down sufficiently before the fan starts.	0	0	600
<i>I45</i>	Ventilation shutdown delay(s) (can only be used if electrical resistance is active) Specifies the minimum fan maintenance delay after deactivation of the electrical resistance in order to avoid overheating the electrical resistor.	0	0	600

Parameter	Description	Default	Min	Max
<i>I46</i>	Fan boost Allows specification of the fan coil unit start-up during regulation 0=ventilation start-up at desired speed 1=ventilation start-up at maximum speed for 1 s before switching to the desired speed	1	0	1
<i>I47</i>	Speed maintained when setpoint is reached. Allows speed 1 to be maintained in the absence of season-based regulation. 0=fan coil unit stopped when setpoint is reached 1=fan coil unit at speed 1 when setpoint is reached 2=fan coil unit at speed 1 when cooling only setpoint is reached 3=fan coil unit at speed 1 when heating only setpoint is reached 4=fan coil unit at selected manual speed when setpoint is reached 5=fan coil unit at selected manual speed when cooling only setpoint is reached 6=fan coil unit at selected manual speed when heating only setpoint is reached	0	0	6
<i>I48</i>	Air destratification function Defines whether to start the fan coil unit at minimum speed in the absence of regulation to avoid air stratification when the regulation sensor is mounted on the fan coil unit intake. 0=Off 1=On 2=On only in heating mode 3=On only in cooling mode	1	0	3
<i>I49</i>	Fan coil unit start-up time during destratification cycle (minutes)	1	1	5
<i>I50</i>	Fan coil unit downtime in the absence of regulation before implementing a new destratification cycle (minutes)	10	1	60
<i>I51</i>	Maximum fan coil unit operating time before the filter is considered to be dirty (hours) 0=function not used X=maximum hours of fan operation before a message appears on the display.	2000	0	9990
<i>I52</i>	Valve stroke time for 3-point regulation (seconds)	60	30	180
<i>I53</i>	Reset of the counter for the hours of fan coil unit operation for the slave in question The hours of fan coil unit operation are stored in memory. When they exceed <i>I51</i> , the  icon appears. To clear the counter, input <i>I53</i> =1. Automatically the parameter switches to 0 after resetting	0	0	1

if a THS2 is connected to a THS2-0MM slave, only parameters *I24*, *I25*, *I53* can be modified.



40. Setting setpoints parameters (level 2 password)

The setpoint parameters on a THS2 connected to THS2-0MM master are password-protected.

Any modification done on parameters are transferred to the THS2-0MM after exiting the setpoints parameters menu.

Press the  and  keys simultaneously to access the general menu. The following screen appears:



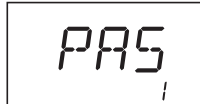

Press the  or  key until the following screen appears:







Press the  key and then the  key until the value **22** is displayed.

Press the  key to access level 2. The screen corresponding to the first parameter of level 2 appears:



Use the  or  key to scroll through the parameters.

To change a parameter, press the  key and then the  or  key to select its value.

Press the  key to save the value, or the  key to exit parameter modification without saving the changes.

To exit the menu, press the  key one or more times or wait approximately 120 seconds.

Parameter	Description	Default	Min	Max
C01	Heating setpoint for 2-pipe regulation (°C)	20.0	C05	C04
C02	Cooling setpoint for 2-pipe regulation (°C)	25.0	C07	C06
C03	Setpoint for 4-pipe regulation (°C)	21.0	C05	C04
C04	Maximum limit of heating regulation setpoint (°C) Limits the maximum value of the setpoints C01 and C03	40.0	C05	50.0
C05	Minimum limit of heating regulation setpoint (°C) Limits the minimum value of the setpoints C01 and C03	6.0	6.0	C04
C06	Maximum limit of cooling regulation setpoint (°C) Limits the maximum value of the setpoint C02.	40.0	C07	50.0
C07	Minimum limit of cooling regulation setpoint (°C) Limits the minimum value of the setpoint C02.	6.0	6.0	C06
C08	Economy offset (°C) In economy mode, the cooling working setpoint is increased by C08 In economy mode, the heating working setpoint is decreased by C08 Example: C08=3 WHS=20-C08=17°C WCS=25+C08=28°C	3.0	0.0	6.0
C09	"Unoccupied holidays" operating mode offset (°C) In "unoccupied holidays" mode, the cooling working setpoint is increased by C09 In "unoccupied holidays" mode, the heating working setpoint is decreased by C09 Example: C09=5 WHS=20-C09=15°C WCS=25+C09=30°C	5.0	0.0	14.0
C10	Neutral zone for 4-pipe systems (°C)	0.5	0.5	5.0
C11	Heating insertion differential during summer (mid-season) (°C)	3.0	0.5	10.0
C12	Frost protection setpoint (°C)	5.0	4.0	10.0
C13	Heating setpoint for automatic season changeover sensor (water sensor) (°C).	28.0	26.0	40.0
C14	Cooling setpoint for automatic season changeover sensor (water sensor) (°C).	17.0	10.0	25.0
C15	Minimum thermostat setpoint (°C) (hysteresis fixed at 2°C) (see "23. Minimum thermostat" page 48)	21.0	19.0	50.0
C16	Season selection in 2-pipe systems with water sensor temperature between C14 and C13 (see paragraph "9. Automatic season changeover with water sensor" page 20) 0=heating (at power-on) 1=cooling (at power-on) 2=season not defined, regulation stopped	0	0	2

Parameter	Description	Default	Min	Max
€ 17	IAQ air exchange setpoint (ppm)	800	0	2000
€ 18	Proportional band or IAQ hysteresis (ppm)	200	50	500
€ 19	Minimum modulating damper opening for IAQ (%)	10	0	100
€ 20	Humidity setpoint for dehumidification (% RH)	50.0	5	100
€ 21	Proportional band or humidity hysteresis by dehumidification (% RH)	5.0	2.0	100

if a THS2 is connected to a THS2-0MM slave this level is not accessible.

41. Setting THS2 parameters (level 3 password)

The THS2 parameters are password-protected.

Press the  and  keys simultaneously to access the general menu. The following screen appears:





Press the  or  key until the following screen appears:



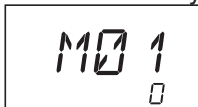

Press the  key and then the  key until the value **33** is displayed.

Press the  key to access level 3. The screen corresponding to the first parameter of level 3 appears:



Use the  or  key to scroll through the parameters.

To change a parameter, press the  key and then the  or  key to select its value.

Press the  key to save the value, or the  key to exit parameter modification without saving the changes.

To exit the menu, press the  key one or more times or wait approximately 120 seconds.

Parameter	Description	Default	Min	Max
M01	Function of digital input 1: 0=not used 1=remote season changeover (INPUT ON=winter, INPUT OFF=summer) 2=not used 3=unoccupied holidays (INPUT ON=occupied) 4=economy (INPUT ON=economy active) 5=window contact (INPUT OFF=window open) 6=alarm (INPUT ON=alarm occurrence) 7=minimum thermostat contact, fan coil unit battery fluid (INPUT ON=thermostat closed)	0	0	7
M02	Digital input 1 contact logic: 0=normally open (open=INPUT OFF, closed=INPUT ON) 1=normally closed (closed=INPUT OFF, open=INPUT ON)	0	0	1
M03	Function of digital input 2: 0=not used 1=remote season changeover (INPUT ON=winter, INPUT OFF=summer) 2=not used 3=unoccupied holidays (INPUT ON=occupied) 4=economy (INPUT ON=economy active) 5=window contact (INPUT OFF=window open) 6=alarm (INPUT ON=alarm occurrence) 7=minimum thermostat contact, fan coil unit battery fluid (INPUT ON=thermostat closed)	0	0	7
M04	Digital input 2 contact logic: 0=normally open (open=INPUT OFF, closed=INPUT ON) 1=normally closed (closed=INPUT OFF, open=INPUT ON)	0	0	1
M05	Number displayed on <u>display A</u> 0=temperature of internal sensor of the THS2 1=humidity of internal sensor of the THS2 2=operating temperature of displayed THS2-0MM (see “6. Regulation sensor” page 13) 3=working setpoint of displayed THS2-0MM (see “10. Working setpoint, economy and unoccupied holidays mode” page 21) 4=humidity value from the humidity transmitter connected to the internal network	2	0	4

Parameter	Description	Default	Min	Max
M06	Number displayed on <u>display B</u> 0=temperature of internal sensor of the THS2 1=humidity of internal sensor of the THS2 2=operating temperature of displayed THS2-0MM (see “6. Regulation sensor” page 13) 3=working setpoint of displayed THS2-0MM (see “10. Working setpoint, economy and unoccupied holidays mode” page 21) 4=humidity value from the humidity transmitter connected to the internal network 5=current hour:minutes 6=CO ₂ value from the CO ₂ transmitter connected to the internal network 7= <u>display B</u> off	3	0	7
M07	MODE key function 0=local season changeover 1=timer extension 2=operating mode (normal, with time bands or "unoccupied holidays")	0	0	2
M08	Summertime changeover Allows specification as to whether summertime is automatically changed over 0=no automatic summertime update 1=automatic summertime changeover Europe	1	0	1
M09	Extension timer duration (minutes) With the timer extension function activated, <ul style="list-style-type: none"> If M10=0, the working setpoint does not take economy and unoccupied holidays modes into account for time M09 If M10=1, the unit remains on for time M09 regardless of the time bands. 	60	1	480
M10	Time band function 0=time bands for normal/economy operation 1=time bands for switching the unit on and off	1	0	1
M11	COMFORT mode 0=current setpoint can be modified in quick access 1=offset setpoint can be edited in quick access For more details, see paragraph “Setting the setpoint and offset setpoint” page 55	0	0	1
M12	Setpoint offset range applied in comfort mode (°C) or to the remote setpoint variator SAP-NTC20-02-2-EV. Defines the extent to which the setpoint can vary in comfort mode or the remote setpoint variator can vary.	6.0	0	10
M13	Mid-season mode activation 0=mid-season mode not activated 1=mid-season mode activated. In cooling mode, it is possible to heat with electrical resistance, if the temperature drops too far below the setpoint (see mid-season operation)	0	0	1
M14	Manual shutdown priority 0=non-priority manual on/off 1=priority manual on/off	0	0	1
M15	Temperature correction for internal temperature sensor of THS2 (°C) The correction parameter M15 is added to the temperature read by the internal sensor of the THS2	0	-5.0	5.0
M16	Correction for internal humidity sensor of THS2 (% RH) Correction parameter M16 is added to the humidity read by the internal sensor of the THS2	0	-10.0	10.0
M17	Baud rate of external Modbus network (towards supervisor or THS2 in CN5) 3=9600 bit/s 4=19200 bit/s 5=38400 bit/s	4	3	5
M18	External Modbus network parity (towards supervisor or THS2 in CN5) 0=none 1=odd 2=even	2	0	2
M19	Address of THS2-0MM master in the external Modbus network (towards supervisor or THS2 in CN5) when jumper J2=ON and SW3≠0. Address of THS2-0MM slave in the external and internal Modbus network when jumper J2=ON and SW3=0. 1..247=valid address 248=not valid address To change address of THS2-0MM master do the following procedure: - Mount jumper J2 on TH2-0MM master - Change M19 parameter and exit parameter setting to transmit new address (by optional THS2 or by supervisor) - Do new connection (by optional THS2 or by supervisor) with new address	1	1	248

Parameter	Description	Default	Min	Max
M20	Total of THS2-0MM in the internal network: (slave units + master unit, excluding any transmitter).	1	1	15
M21	Presence of a transmitter in the internal network 0=no transmitter connected to internal network 1=humidity, CO ₂ transmitter connected to internal network	0	0	1
M22	0 = THS2 can only control setpoint, offset setpoint, speed, on/off and send internal temperature and humidity to THS2-0MM connected. 1 = THS2 can only control setpoint, offset setpoint, speed, on/off and does not send internal temperature and humidity to THS2-0MM. 2=THS2 visualizes the state of THS2-0MM connected, it does not control any parameter	1	0	2
M23	Time before exiting parameters setting when no key is pressed (s): During that time the backlight of display remains ON (s): This time is not applied when accessing quick access on THS2 like keypad lock, global on/off, setpoint or offset setpoint, fan operating mode, function with MODE key.	120	4	240



if a THS2 is connected to a THS2-0MM slave, only parameters M05, M06, M08, M10, M11, M14 to M19, M22 M23 can be modified.

42. Setting CN4 communication parameters (level 4 password)

The THS2 parameters are password-protected. CN4 communication parameters baud rate and parity can be modified only with SW3 in position 0 with J2=ON for THS2-0MM slaves connected to THS2 on CN5 and supervisor on CN4. For the other cases in which a THS2-0MM is connected together with THS2-0MM slaves (SW3≠0) on CN4 the settings done are not considered and communication parameters are automatically set to 9600 bit/s with even parity and can't be changed.

Press the  and  keys simultaneously to access the general menu. The following screen appears:



Press the  or  key until the following screen appears:







Press the  key and then the  key until the value **35** is displayed.

Press the  key to access level 3. The screen corresponding to the first parameter of level 3 appears:



Use the  or  key to scroll through the parameters.

To change a parameter, press the  key and then the  or  key to select its value.

Press the  key to save the value, or the  key to exit parameter modification without saving the changes.

To exit the menu, press the  key one or more times or wait approximately 120 seconds.

Parameter	Description	Default	Min	Max
L01	Baud rate of internal Modbus network (if J2 ON and SW3=0) 3=9600 bit/s 4=19200 bit/s 5=38400 bit/s	3	3	5
L02	Internal Modbus network parity (if J2 ON and SW3=0) 0=none 1=odd 2=even	2	0	2

Parameters L01 and L02 are considered when SW3=0. In other cases the setting done on these parameters are not considered. The baud rate is forced to 9600 bits/s and parity to even.

43. Logic of digital inputs THS2

• Digital THS2 inputs DI1 and DI2

Parameter	Logic		
M01=0 (Input DI1) or M03=0 (Input DI2) Not used			
M01=1 (Input DI1) or M03=1 (Input DI2) Remote contact for season changeover	Logic DI1 M02 = Logic DI2 M04 =	0	1
	Summer		
	Winter		
M01=2 not selectable			
M01=3 (Input DI1) or M03=3 (Input DI2) Unoccupied	Logic DI1 M02 = Logic DI2 M04 =	0	1
	"Unoccupied holidays" mode		
	"occupied" mode		
M01=4 (Input DI1) or M03=4 (Input DI2) Energy saving	Logic DI1 M02 = Logic DI2 M04 =	0	1
	No economy		
	Economy		
M01=5 (Input DI1) or M03=5 (Input DI2) Window contact	Logic DI1 M02 = Logic DI2 M04 =	0	1
	Window open		
	Window closed		
M01=6 (Input DI1) or M03=6 (Input DI2) Generic alarm	Logic DI1 M02 = Logic DI2 M04 =	0	1
	Alarm absent		
	Alarm present		
M01=7 (Input DI1) or M03=7 (Input DI2) Minimum thermostat	Logic DI1 M02 = Logic DI2 M04 =	0	1
	Open		
	Closed		

The contacts set on THS2 as remote contact change-over, unoccupied, energy saving, or window contact have higher priority than those set with the same function on THS2-0MM master unit

44. Input/output status of THS2-0MM connected to THS2

The status of inputs and outputs can be displayed during operation for THS2 unit and THS2-0MM at which it is connected.

Press the and keys simultaneously to access the general menu. The following screen appears:



Press the or key until the following screen appears:

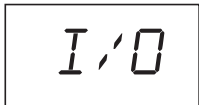



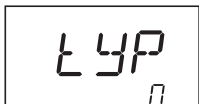

Press the key to access the list of inputs and outputs.



The screen that allows you to select the unit for which you wish to display the input/output status appears first:



The second row indicates the current unit connected to THS2(1=slave/master 1, 2=slave/master 2, etc.,







10=slave/master 10, 15=slave/master 15 M=THS2).



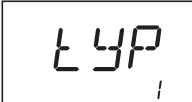
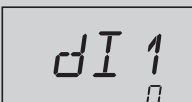
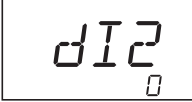
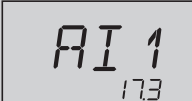

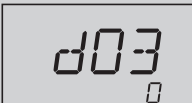

To change the displayed controller, press the  key (the current unit flashes) and then the  or  key until the desired controller is displayed. Then press the  key again to validate your selection.

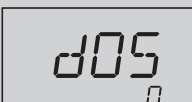
Use the  or  key to scroll through the status of the inputs and outputs present in the selected unit.

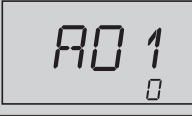
The following screens are displayed:

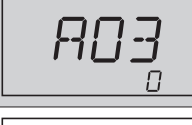
For the THS2-0MM connected to the display THS2:

Screen	Input/Output	Display B indicator (second row)
	Selection of displayed controller	M=THS2 x=internal address of THS2-0MM [x can be one of those following values: 1, 2, 3, 4, 5, 6, 7, 8, 9, 10(A), 11(B), 12(C), 13(D), 14(E), 15(F)]
	Digital input 1	0=contact open 1=contact closed
	Digital input 2	0=contact open 1=contact closed
 for THS2-0MM only	Analogue input 1 (for THS2-0MM units only):	Sensor input I 11 <= 3: -LL=sensor open -HL=sensor short-circuited - 150..900=temperature no 5=input not used (I 11=0)
		Contact input I 11 >= 4 and I 11 <= 9: 0=contact open 1=contact closed
		Set remote variator input I 11=10: offset value of the variator (if not connected value=00)
 for THS2-0MM only	Analogue input 2 (for THS2-0MM units only):	Sensor input I 13 <= 3: -LL=sensor open -HL=sensor short-circuited - 150..900=temperature no 5=input not used (I 13=0)
		Contact input I 13 >= 4 and I 13 <= 9: 0=contact open 1=contact closed
		Set remote variator input I 13=10: offset value of the variator (if not connected value=00)
 for THS2-0MM only	Digital output 1, on/off or 3-point valve opening or closure	0=relay deactivated 1=relay activated 6=destratification cycle in progress (I 15=1)
 for THS2-0MM only	Digital output 2, on/off or 3-point valve opening or closure	0=relay deactivated 1=relay activated 6=destratification cycle in progress (I 16=1)
 for THS2-0MM only	Digital output 3, on/off or 3-point valve opening or closure	0=relay deactivated 1=relay activated 6=destratification cycle in progress (I 17=1)
 for THS2-0MM only	Digital output 4	0=relay deactivated 1=relay activated 6=destratification cycle in progress (I 18=1)
 for THS2-0MM only	Digital output 5, on/off or 3-point valve opening or closure	0=relay deactivated 1=relay activated 6=destratification cycle in progress (I 19=1)

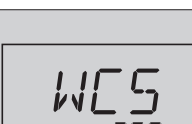
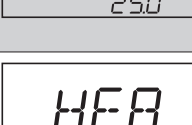
 for THS2-0MM only	Digital output 6, on/off or 3-point valve opening or closure	0=relay deactivated 1=relay activated 6=destratification cycle in progress (<i>I20</i> =1)
 for THS2-0MM only	Analogue output 1	00..1000=voltage (x10) > 1000=destratification cycle in progress with EC fan: voltage (x10)=reading - 1000
 for THS2-0MM only	Analogue output 2	00..1000=voltage (x10) > 1000=destratification cycle in progress with EC fan: voltage (x10)=reading - 1000
 for THS2-0MM only	Analogue output 3	00..1000=voltage (x10) > 1000=destratification cycle in progress with EC fan: voltage (x10)=reading - 1000
 for THS2-0MM only	Communication status between THS2-0MM and THS2 in real time.	0=no error 1=timeout 2=incorrect data or routing 3=other communication errors
 for THS2-0MM only	Operating temperature	-500=sensor open or short-circuited - 150..900=temperature
 for THS2-0MM only	Working setpoint in heating mode	-300=forced operating setpoint with open or short-circuited sensor 700=forced operation setpoint with active frost protection ----=setpoint not calculated other values=calculated operation setting
 for THS2-0MM only	Working setpoint in cooling mode	900=forced operation setpoint with open or short-circuited sensor 710=forced operation setpoint with active frost protection ----=setpoint not calculated other values=calculated operation setting
 for THS2-0MM only	Current hours of fan operation	0..9999=hours of operation

For the THS2 unit:

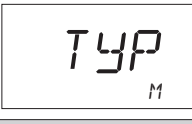
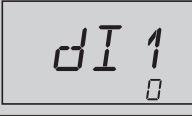
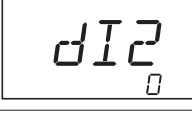
Screen	Input/Output	Display B indicator (second row)
	Selection of displayed controller	M=display
	Digital input 1	0=contact open 1=contact closed
	Digital input 2	0=contact open 1=contact closed

To exit the menu, press the  key one or more times or wait approximately 120 seconds.

45. Display of THS2-0MM operating by THS2 connected

The icons related to the operation of a specific THS2-0MM can be seen on the display.

To do so, connect the THS2 to the specific THS2-0MM, if connection couldn't be established after power up the following message is displayed.



To do the connection press the keys + simultaneously, the following message appears on the display:



Press the key the current address is flashing. With keys or select the new address and press the the key to save the selection or the key to exit parameter modification without saving the changes

The address to select is the same as internal address if J2 is unmounted (OFF). It corresponds to the setting done on rotary switch SW3. If J2 is mounted (ON), it corresponds to the parameter *M19*.

If connection could be then established, the screen with operating mode is displayed.





The measure to be displayed on display A (first row) and display B (second row) can be selected by setting the parameters *M05* and *M06*. Depending on the measure selected, the ranges of values that can be displayed are shown in the table below:





Value of parameter <i>M05</i> (0 to 5), <i>M06</i>	Display indicator
0=temperature of internal sensor of the THS2	-200..600 (approximately)
1=humidity of internal sensor of the THS2	00..100=humidity
2=displayed slave operating temperature	-500=sensor open or short-circuited - 150..900=temperature
3=working setpoint of displayed slave	In heating mode: -300=forced operating set with open or short-circuited sensor 700=forced operation setting with active frost protection ---- =setpoint not calculated other values=calculated operation setting
	In cooling mode: 900=forced operation setting with open or short-circuited sensor 710=forced operation setting with active frost protection ---- =setpoint not calculated other values=calculated operation setting
4=setpoint variation of displayed slave (or working setpoint of displayed slave, if no analogue input is configured as remote setpoint variator)	Remote variator input setpoint <i>I11</i> ≠10 or <i>I13</i> ≠10: variator offset value if connected otherwise 00
	In heating mode (<i>I11</i> ≠10 and <i>I13</i> ≠10): -300=forced operation set with sensor open or short-circuited 700=forced operation setting with active frost protection ---- =setpoint not calculated other values=calculated operation setting
	In cooling mode (<i>I11</i> ≠10 and <i>I13</i> ≠10): 900=forced operation setting with open or short-circuited sensor 710=forced operation setting with active frost protection ---- =setpoint not calculated other values=calculated operation setting
5=humidity value from the humidity transmitter connected to the internal network	00..100=humidity
6=current hour:minutes (<i>M06</i> only)	HH:MM with HH=hour 0-23 and MM=minutes 0-59
7=CO ₂ value from the CO ₂ transmitter connected to the internal network (<i>M06</i> only)	0...2000 ppm
8=display B off	

Note: If communication parameters change between THS2 and THS2-0MM and THS2 is not able to communicate with the THS2-0MM, the letter **E** of the small display flashes on the display along with the  ⁴⁸⁵ icons.





Press the keys  +  simultaneously, the following message appears on the display:





Press the  key the current address is flashing. With keys  or  select the new address and press the the  key to save the selection or the  key to exit parameter modification without saving the changes. After several seconds if the message doesn't disappear verify that communication parameters *M 17* and *M 1B* are set correctly.

46. Monitoring status internal network (from THS2)

If a THS2 is connected to a THS2-0MM master for internal network, it is possible to monitor operating conditions of each other THS2-0MM slaves connected to the internal network

Press the  and  keys simultaneously to access the general menu. The following screen appears:







Press the  or  key until the following screen appears:



Press the  key and then the  key until the value **55** is displayed.

Press the  key to access monitoring level. The screen corresponding to the first parameter of level monitoring appears:



To change the displayed controller, press the  key (the current unit flashes) and then the  or  key until the desired controller is displayed. Then press the  key again to validate your selection.

To exit the menu, press the  key one or more times or wait approximately 120 seconds.

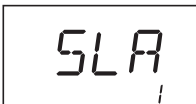
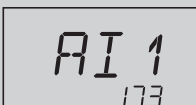

Use then the  or  key to scroll through the variables. The following screens are displayed:

Screen	Input/Output	Display B indicator (second row)
	Selection of displayed controller	<i>M</i> =THS2 * = internal address of THS2-0MM [x can be one of those following values: 1 to 15 or 't' for optional transmitter]
	Analogue input 1	Sensor input <i>I 11</i> <= 3: - LL = sensor open - HL = sensor short-circuited - 150..900 = temperature no 5 = input not used (<i>I 11</i> ≠ 0)
		Contact input <i>I 11</i> >= 4 and <i>I 11</i> <= 9: 0 = contact open 1 = contact closed
		Set remote variator input <i>I 11</i> = 10: offset value of the variator (if not connected value = 00)

<div style="border: 1px solid black; padding: 5px; width: fit-content;"> <p style="margin: 0;">AI2 15.8</p> </div>	<p>Analogue input 2</p>	<p>Sensor input I 13 <= 3: -LL=sensor open -HL=sensor short-circuited - 150..900=temperature no5=input not used (I 13=0)</p> <p>Contact input I 13 >= 4 and I 13 <= 9: 0=contact open 1=contact closed</p> <p>Set remote variator input I 13=10: offset value of the variator (if not connected value=00)</p>
<div style="border: 1px solid black; padding: 5px; width: fit-content;"> <p style="margin: 0;">WLE 22.3</p> </div>	<p>Operating temperature</p>	<p>-500=sensor open or short-circuited - 150..900=temperature</p>
<div style="border: 1px solid black; padding: 5px; width: fit-content;"> <p style="margin: 0;">WH5 20.0</p> </div>	<p>Working setpoint in heating mode</p>	<p>-300=forced operating setpoint with open or short-circuited sensor 700=forced operation setpoint with active frost protection ----=setpoint not calculated other values=calculated operation setting</p>
<div style="border: 1px solid black; padding: 5px; width: fit-content;"> <p style="margin: 0;">WC5 25.0</p> </div>	<p>Working setpoint in cooling mode</p>	<p>980=forced operation setpoint with open or short-circuited sensor 710=forced operation setpoint with active frost protection ----=setpoint not calculated other values=calculated operation setting</p>
<div style="border: 1px solid black; padding: 5px; width: fit-content;"> <p style="margin: 0;">FAS 3</p> </div>	<p>Current fan speed</p>	<p>1=speed 1 2=speed 2 3=speed 3</p>
<div style="border: 1px solid black; padding: 5px; width: fit-content;"> <p style="margin: 0;">HFA 803</p> </div>	<p>Current hours of fan operation</p>	<p>0..9999=hours of operation</p>
<div style="border: 1px solid black; padding: 5px; width: fit-content;"> <p style="margin: 0;">ITE 22.3</p> </div>	<p>Temperature value internal sensor THS2</p>	<p>-200..900</p>
<div style="border: 1px solid black; padding: 5px; width: fit-content;"> <p style="margin: 0;">IHU 36.1</p> </div>	<p>Humidity value internal sensor THS2</p>	<p>0..100</p>
<div style="border: 1px solid black; padding: 5px; width: fit-content;"> <p style="margin: 0;">ONF 1</p> </div>	<p>On/off status</p>	<p>0=ON 1=OFF</p>
<div style="border: 1px solid black; padding: 5px; width: fit-content;"> <p style="margin: 0;">FAR 3</p> </div>	<p>Fan speed required</p>	<p>1=speed 1 2=speed 2 3=speed 3 4=automatic speed</p>
<div style="border: 1px solid black; padding: 5px; width: fit-content;"> <p style="margin: 0;">OFR 10</p> </div>	<p>Offset setpoint required in Comfort mode</p>	<p>-M12 to M12</p>
<div style="border: 1px solid black; padding: 5px; width: fit-content;"> <p style="margin: 0;">SEU 20.0</p> </div>	<p>Regulation setpoint required</p>	<p>C05 to C04 for 2-,4-pipe heating setpoint C07 to C06 for 2-pipe cooling setpoint</p>

47. Restoring default parameters

To reload part of the initial configuration of the default parameters, proceed as follows on the THS2 connected to the THS2-0MM master:

Press the  and  keys simultaneously to access the general menu. The following screen appears:



Press the  or  key until the following screen appears:





Press the  key and then the  key until the value **44** is displayed.

Press the  key to access the restore default parameters level.



To cancel and return to regulation, press the  key.

To start the procedure, press the  key; the value on display B flashes. Press the  key to import the value for the group of parameters that you wish to set to the default values, and press the  key again.

Value of Parameter	Description
0	no parameters to be set to the default value
1	parameters with password 11 to be set to default values
2	parameters with password 22 to be set to default values
3	time bands to be set to default values
4	all parameters set to default values

The default parameter loading procedure starts, and the following messages are displayed:

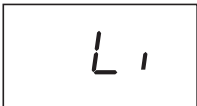

start of default parameter loading phase

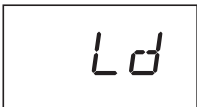

end of default parameter loading phase

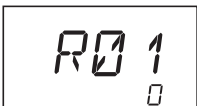

When the following screen appears again, you can exit the menu by pressing the  key once or waiting for approximately 120 seconds.





All parameters except communication parameters *M 17*, *M 18*, *M 19* are resetted to default values.

48. Firmware version display

To display the firmware version, proceed as follows:

Press the  and  keys simultaneously to access the general menu. The following screen appears:





Press the  or  key until the following screen appears:



Press the  key and then the  key until the value **25** is displayed.

Press the  key to access the versions parameter level.



Use the  or  key to scroll through the parameters.

To exit the menu, press the  key one or more times or wait approximately 120 seconds.

Parameter	Description	Value	Min	Max
U01	Highest weight of firmware version of THS2	x	0	9
U02	Intermediate weight of firmware version of THS2	y	0	9
U03	Lowest weight of firmware version of THS2	z	0	9
U04	Firmware version of THS2-0MM connected	xyz	0	999

The firmware version of THS2 is x.y.z

The firmware version of THS2-0MM = value of parameter U04.

49. USB connection

The THS2 unit implements a USB "device" type of interface that can be used to configure time bands or update software. To connect the controller to a personal computer via USB, use a cable with "Type A" connectors on one side and "Mini B" connectors on the other side.

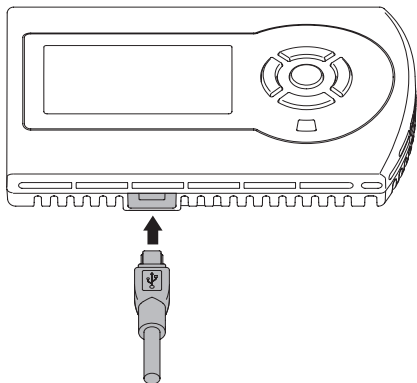

The connection can be made either with the device live or without supply voltage.

When the USB cable is connected to the THS2 unit, the display turns off and the unit stands by for configuration or a software update.

The slave unit implements a USB "device" type of interface that can be used to update the software.

To connect the controller to a personal computer via USB, use a cable with "Type A" connectors on one side and "Mini B" connectors on the other side.

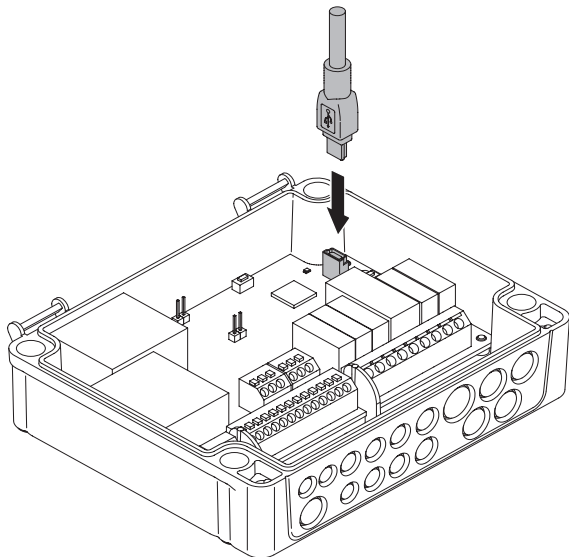

The connection must be made when THS2-0MM is powered on.

When the USB cable is connected to the unit, press the reset button (see [“53. Electrical connections” page 113](#) slave unit connections). The LED stops flashing, and the unit stands by for a software update. At the end of software update hit the key reset again.

50. Jumper configuration

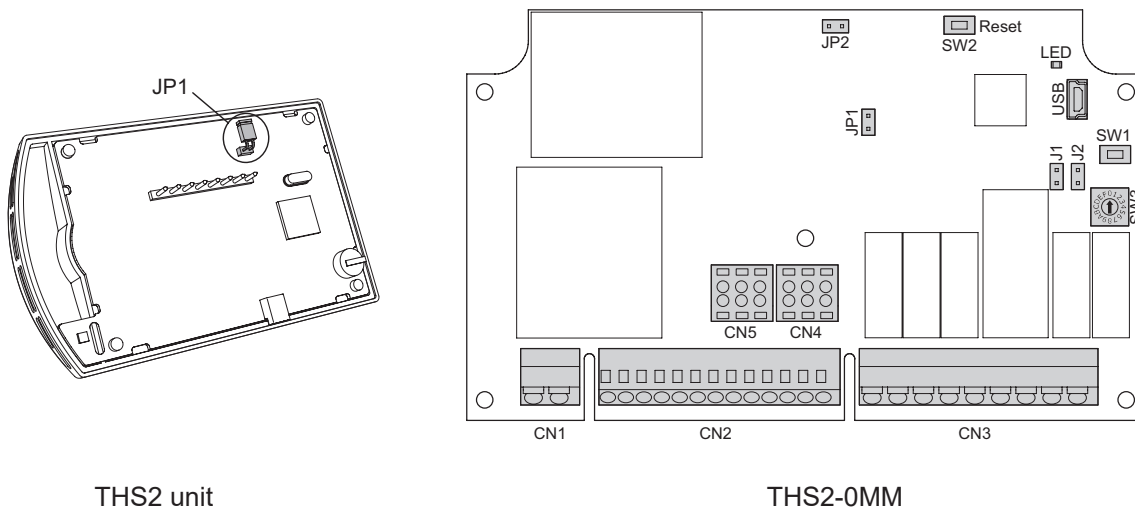

THS2 unit:

JP1=Term. ON → 120 ohm external network Modbus line termination resistance INSERTED.

JP1=OFF → 120 ohm external network Modbus line termination resistance NOT INSERTED.

THS2-0MM unit:

JP1=Term. ON → 120 ohm internal network line termination resistance INSERTED.

JP1=OFF → 120 ohm internal network line termination resistance NOT INSERTED.

JP2=Term. ON → 120 ohm external (to supervisor or THS2) Modbus line termination resistance INSERTED.

JP2=OFF → 120 ohm resistance for external Modbus line termination (to supervisor) NOT INSERTED.

[SW3≠0: network on CN4 with THS2-0MM master + THS2-0MM slaves, supervisor or THS2 on CN5 of THS2-0MM master, others THS2 connected to slaves on CN5]:

J1 = ON -> THS2-0MM is the master for internal network. **SELECT ONLY 1 MASTER FOR EACH INTERNAL NETWORK.**

J1 = OFF -> THS2-0MM is a slave for internal network.

J2 = ON -> the address of THS2-0MM master in the external network is variable **ADR_MOD_MODBUS_ADDRESS_NETWORK** (11149) (parameter # 19)

J2 = OFF -> the address of THS2-0MM master or slave in the external network is the address set on rotary switch SW3.

[SW3=0: network on CN4 with THS2-0MM slaves, supervisor on CN4, others THS2 connected to THS2-0MM slave on CN5]:

J1 = OFF -> THS2-0MM is a slave for internal network.

J2 = ON -> the address of THS2-0MM slave in the internal network is variable **ADR_MOD_MODBUS_ADDRESS_NETWORK** (11149) (parameter # 19)

51. Forcing digital and analogue slave inputs/outputs

• Forcing outputs

Any output of a THS2-0MM master and slaves can be forced via Modbus regardless of the regulation. To implement the forcing, proceed as follows on slave:

- write the value **22222** to address **STATUS_PRESENCE_SUPERVISOR_DISPLAY** (11033).

- write the forcing value for outputs to be forced at master x address between **ADR_MOD_FORCE_DO1** (11053) to **ADR_MOD_FORCE_AO3** (11061):

- write a forcing key indicating which output(s) are to be forced to the following master x address: **ADR_MOD_KEYSELECT_FORCED_OUTPUTS** (11052).

This forcing will be then transmitted to other slaves so that operating is the same on the entire internal network.

Definition of the forcing key for the outputs:

The forcing key is a variable composed of a fixed part to which the value corresponding to one or more outputs to be forced is added (see table below):

Fixed part=21504	Value for each forced output to be added to the fixed part								
	A03	A02	A01	DO6	DO5	DO4	DO3	DO2	DO1
	256	128	64	32	16	8	4	2	1

Example 1: the forcing key for forcing outputs D02 and A01 is $21504 + 2 + 64 = 21570$.

Example 2: the forcing key for forcing output D04 is $21504 + 8 = 21512$.

Forcing values should be written to the addresses given in the following table on THS2-0MM master unit:

Detailed list of forcible registers	Min	Max	Address	Variable
ADR_MOD_FORCED_DO1 → Forces THS2-0MM digital output 1 0=relay 1 deactivated 1=relay 1 activated	0	1	11053	DO1
ADR_MOD_FORCED_DO2 → Forces THS2-0MM digital output 2 0=relay 2 deactivated 1=relay 2 activated	0	1	11054	DO2
ADR_MOD_FORCED_DO3 → Forces THS2-0MM digital output 3 0=relay 3 deactivated 1=relay 3 activated	0	1	11055	DO3
ADR_MOD_FORCED_DO4 → Forces THS2-0MM digital output 4 0=relay 4 deactivated 1=relay 4 activated	0	1	11056	DO4
ADR_MOD_FORCED_DO5 → Forces THS2-0MM digital output 5 0=relay 5 deactivated 1=relay 5 activated	0	1	11057	DO5
ADR_MOD_FORCED_DO6 → Forces THS2-0MM digital output 6 0=relay 6 deactivated 1=relay 6 activated	0	1	11058	DO6
ADR_MOD_FORCED_AO1 → Forces THS2-0MM analogue output 1 0=0 V 1000=10 V	0	1000	11059	AO1
ADR_MOD_FORCED_AO2 → Forces THS2-0MM analogue output 2 0=0 V 1000=10 V	0	1000	11060	AO2
ADR_MOD_FORCED_AO3 → Forces THS2-0MM analogue output 3 0=0 V 1000=10 V	0	1000	11061	AO3

Example 1:

enabling relay 1 in forcing mode:

Forcing key -> $21504 + 1 = 21505$.

Write the key variable to **ADR_MOD_KEYSELECT_FORCED_OUTPUTS** (11052)

Relay activation: write variable **ADR_MOD_FORCE_DO1** (11053) to 1.

Relay deactivation: write variable **ADR_MOD_FORCE_DO1** (11053) to 0.

It is possible to enable more than one output for forcing mode.

Example 2:

enabling relays 2 and 3, and analogue output **AO1** in forcing mode:

Forcing key= $21504 + 2 + 4 + 64=21574$ in decimals.

Write 21574 in variable **ADR_MOD_KEYSELECT_FORCED_OUTPUTS** (11052)

To activate relay 2, write variable **ADR_MOD_FORCE_DO2** (11054) to 1.

To activate relay 3, write variable **ADR_MOD_FORCE_DO3** (11055) to 1.

To set output AO1 to 4.2 V, write variable **ADR_MOD_FORCE_AO1** (11059) to 420.

To exit forcing mode, write the value 0 to address **ADR_MOD_KEYSELECT_FORCED_OUTPUTS** (11052).

• Forcing inputs

Any input of a THS2-0MM master and slaves can be forced via Modbus regardless of the regulation. To implement the forcing, proceed as follows on THS2-0MM master:

- write the value **22222** to address **STATUS_PRESENCE_SUPERVISOR_DISPLAY** (11033).

- when forcing a digital input, write the following value to be forced to address **ADR_MOD_FORCE_DI1** (11063) for digital input DI1 and/or to address **ADR_MOD_FORCE_DI2** (11064) for digital input DI2:

0=contact forced open

1=contact forced closed

- when forcing an analogue input, write the following value to be forced regardless of the sensor configuration from the list below at address **ADR_MOD_FORCE_AI1** (11065) for analogue input AI1 and/or, at address **ADR_MOD_FORCE_AI2** (11066) for analogue input AI2:

-200=sensor open

970=sensor short-circuited.

-150...900=sensor present with value equivalent to temperature multiplied by 10.

If you wish to force a remote setpoint variation between $-M_{12}$ and M_{12} with sensor AIx configured as a remote setpoint variator $I_{11}=10$ (AI1) and $I_{13}=10$ (AI2), force a value as indicated below:

if, for example, $M_{12}=10.0$, force a value between -100 and 100. A forced value of 50 corresponds to 5.0°C.

A forced value outside the range set by parameter M_{12} will not be taken into account.

- write a forcing key indicating which input(s) are to be forced at THS2-0MM address: **ADR_MOD_KEYSELECT_FORCED_INPUTS** (11062).

This forcing will be then transmitted to the other slaves so that operating is the same on the entire internal network.

Definition of the forcing key for the inputs:

The forcing key is a variable composed of a fixed part to which the value corresponding to one or more inputs or sensors to be forced is added (see table below)

Fixed part=26112	Value for each input or forced sensor to be added to the fixed part			
	AI2	AI1	DI2	DI1
	8	4	2	1

Example: the forcing key for forcing DI2 and sensor AI1 is $26112 + 2 + 4=26118$

The forcing key must be written to the address **ADR_MOD_KEYSELECT_FORCED_INPUTS** (11062)

Forcing values should be written to the addresses given in the following table on THS2-0MM master:

Detailed list of forcible registers	Min	Max	Address	Var.
ADR_MOD_FORCED_DI1 → Forces THS2-0MM digital input 1 0=contact DI1 open 1=contact DI1 closed	0	1	11063	DI1
ADR_MOD_FORCED_DI2 → Forces THS2-0MM digital input 2 0=contact DI2 open 1=contact DI2 closed	0	1	11064	DI2
ADR_MOD_FORCED_AI1 → Forces THS2-0MM analogue input 1 - temperature sensor value multiplied by 10(°C) if $I_{11} \neq 10$: forcing -200 (corresponding to -20.0°C) corresponds to open sensor AI1; the forcing of 970 (corresponding to 97.0°C) corresponds to short-circuited sensor AI1. - value between $-M_{12}$ and $+M_{12}$ (setpoint variation) multiplied by 10(°C) if $I_{11} = 10$	-150	900	11065	AI1

ADR_MOD_FORCED_AI2 → Forces THS2-0MM analogue input 2 - temperature sensor value multiplied by 10(°C) if $I_{13} \neq 10$: forcing -200 (corresponding to -20.0°C) corresponds to open sensor AI2; the forcing of 970 (corresponding to 97.0°C) corresponds to short-circuited sensor AI2. - value between -1112 and $+1112$ (setpoint variation) multiplied by 10(°C) if $I_{13} = 10$	-150	900	11066	AI2
---	------	-----	-------	-----

Example 1:

Forcing of closed contact on DI1:

Forcing key -> $26112 + 1 = 26113$.

Write 26113 to variable **ADR_MOD_KEYSELECT_FORCED_INPUTS** (11062).

To close contact DI1: write variable **ADR_MOD_FORCE_DI1** (11063) to 1.

Example 2:

Forcing of analogue input AI1 to 26.5°C and contact open on DI2:

Forcing key -> $26112 + 2 + 4 = 26118$.

Write 26118 to variable **ADR_MOD_KEYSELECT_FORCED_INPUTS** (11062).

Opening of contact DI2: write variable **ADR_MOD_FORCE_DI2** (11064) to 0.

AI1=26.5°C: write variable **ADR_MOD_FORCE_AI1** (11065) to 265.

Note:

If the controller is connected to a supervisor control system, and the option of forcing inputs or outputs is selected, AB Industrietechnik is not liable for any damage caused by incorrect control of this type of output.

To exit forcing mode, write the value 0 in the register **ADR_MOD_KEYSELECT_FORCED_INPUTS** (11062).

52. THS2-0MM master Modbus variables

A THS2-0MM is equipped with a second communication port to be connected to a supervision system as Modbus slave or to display terminal THS2.

A supervisor system can only be connected to a THS2-0MM master unit.

All parameters and variables can be accessed by the supervisor as a holding register, and read and write operations must be implemented with the appropriate function codes (FC=03, 06, 16).

Given the large number of parameters, read a maximum of 121 variables at a time.

Choose a minimum timeout of 1 second between each reading (or writing).

A supervision system connected to the external Modbus network can read the status of the master and slaves and their parameters. Any parameter of the master controller can also be set by writing to appropriate addresses.

Modbus network variables

Address	Description	Par	Def	Min	Max	R/W
11000	ADR_MOD_STATUS_DO1 → Status of digital output DO1 If DO1 is used as on/off output: 0=relay 1 deactivated, 1=relay 1 activated. If DO1=fan coil unit speed 1 relay ($I_{15}=1$): 0=speed 1 off, 1=speed 1 activated, 6=destratification cycle in progress. If DO1 is used as a 3-point opening ($I_{15}=15, 17, 19$): 0=opening not driven, 1=opening driven If DO1 used as 3-point closure output, ($I_{15}=16, 18, 20$): 0=closure not driven, 1=closure driven		0	0	1000	R
11001	ADR_MOD_STATUS_DO2 → Status of digital output DO2 If DO2 is used as an on/off output: 0=relay 2 deactivated, 1=relay 2 activated. If DO2=fan coil unit speed 1 relay ($I_{16}=1$): 0=speed 1 off, 1=speed 1 activated, 6=destratification cycle in progress. If DO2 is used as a 3-point opening ($I_{16}=15, 17, 19$): 0=opening not driven, 1=opening driven If DO2 is used as a 3-point closure output, ($I_{16}=16, 18, 20$): 0=closure not driven, 1=closure driven		0	0	1000	R
11002	ADR_MOD_STATUS_DO3 → Status of digital output DO3 If DO3 is used as an on/off output: 0=relay 3 deactivated, 1=relay 3 activated. If DO3=fan coil unit speed 1 relay ($I_{17}=1$): 0=speed 1 off, 1=speed 1 activated, 6=destratification cycle in progress. If DO3 is used as a 3-point opening ($I_{17}=15, 17, 19$): 0=opening not driven, 1=opening driven If DO3 is used as a 3-point closure output, ($I_{17}=16, 18, 20$): 0=closure not driven, 1=closure driven		0	0	1000	R
11003	ADR_MOD_STATUS_DO4 → Status of digital output DO4 If DO4 is used as an on/off output: 0=relay 4 deactivated, 1=relay 4 activated. If DO4=fan coil unit speed 1 relay ($I_{18}=1$): 0=speed 1 off, 1=speed 1 activated, 6=destratification cycle in progress.		0	0	6	R
11004	ADR_MOD_STATUS_DO5 → Status of digital output DO5 If DO5 is used as an on/off output: 0=relay 5 deactivated, 1=relay 5 activated. If DO5=fan coil unit speed 1 relay ($I_{19}=1$): 0=speed 1 off, 1=speed 1 activated, 6=destratification cycle in progress. If DO5 is used as a 3-point opening ($I_{19}=15, 17, 19$): 0=opening not driven, 1=opening driven If DO5 is used as a 3-point closure output, ($I_{19}=16, 18, 20$): 0=closure not driven, 1=closure driven		0	0	1000	R
11005	ADR_MOD_STATUS_DO6 → Status of digital output DO6 If DO6 is used as an on/off output: 0=relay 6 deactivated, 1=relay 6 activated. If DO6=fan coil unit speed 1 relay ($I_{20}=1$): 0=speed 1 off, 1=speed 1 activated, 6=destratification cycle in progress. If DO6 is used as a 3-point opening ($I_{20}=15, 17, 19$): 0=opening not driven, 1=opening driven If DO6 is used as a 3-point closure output, ($I_{20}=16, 18, 20$): 0=closure not driven, 1=closure driven		0	0	1000	R
11006	ADR_MOD_STATUS_AO1 → Status of analogue output 1 0=0 V and 1000=10 V If AO1 is used as the EC motor output ($I_{21}=1$), during destratification cycle the value 1000 is added to the analogue output 1 status value		0	0	2000	R

Address	Description	Par	Def	Min	Max	R/W
11007	ADR_MOD_STATUS_AO2 → Status of analogue output 2 0=0 V and 1000=10 V If AO2 is used as the EC motor output ($I22=1$), during destratification cycle the value 1000 is added to the analogue output 2 status value.		0	0	2000	R
11008	ADR_MOD_STATUS_AO3 → Status of analogue output 3 0=0 V and 1000=10 V If AO3 is used as the EC motor output ($I23=1$), during destratification cycle the value 1000 is added to the analogue output 3 status value.		0	0	2000	R
11009	ADR_MOD_STATUS_DI1 → Status of Input contact DI1 0=contact DI1 open, 1=contact DI1 closed		0	0	1	R
11010	ADR_MOD_STATUS_DI2 → Status of input contact DI2 0=contact DI2 open, 1=contact DI2 closed		0	0	1	R
11011	ADR_MOD_STATUS_AI1 → Remote sensor 1 temperature multiplied by 10(°C) if $I11 \neq 10$ if the sensor is open, the reading is -200 (corresponding to -20.0°C) in case of short-circuit of the sensor, the reading is 970 (corresponding to 97.0°C). → Value between -M12 and +M12 (setpoint variation) multiplied by 10(°C) if $I11 \neq 10$		0	-200	900	R
11012	ADR_MOD_STATUS_AI2 → Remote sensor 2 temperature multiplied by 10(°C) if $I13 \neq 10$ if the sensor is open, the reading is -200 (corresponding to -20.0°C) In case of short-circuit of the sensor, the reading is 970 (corresponding to 97.0°C). → Value between -M12 and +M12 (setpoint variation) multiplied by 10(°C) if $I13 \neq 10$		0	-200	900	R
11013	ADR_MOD_TYPE_SLAVE_UNIT → THS2-0MM function in the internal network 10000 = THS2-0MM is slave on internal network 20000 = THS2-0MM is master on internal network			10000	20000	R
11014	Reserved address					R
11015	ADR_MOD_STATUS_CURRENT_MASTERCURRENTMODEREG → Current type of regulation 0=regulation with base setpoint 1=regulation with base setpoint (within a time band if M10=0) 2=regulation with base setpoint (active forced presence) 3=regulation in economy mode 4=regulation in unoccupied holidays mode 5-9=not used 10=regulation with base setpoint, window open 11=regulation with base setpoint (within a time band if M10=0), window open 12=regulation with base setpoint (active forced presence), window open 13=regulation in economy mode, window open 14=regulation in unoccupied holidays, mode window open			0	14	R
11016	ADR_MOD_STATUS_CURRENT_WORKING_TEMP → Working temperature multiplied by 10 (°C). If the sensor is open, the reading is -200 (corresponding to -20.0°C). In case of short-circuit of the sensor, the reading is 970 (corresponding to 97.0°C).			-150	900	R
11017	ADR_MOD_STATUS_WORKING_SET_HEAT → Calculated WHS working setpoint for heating multiplied by 10 (°C) for THS2-0MM. The reading for the frost protection alarm is 700 (70.0°C). If the operating temperature is in error (heating), the reading is -300 (-30.0°C)			see parameters	see parameters	R
11018	ADR_MOD_STATUS_WORKING_SET_COOL → Calculated WCS working setpoint for cooling multiplied by 10 (°C) for THS2-0MM. The reading for the frost protection alarm is 710 (71.0°C). If the operating temperature is in error (cooling), the reading is 980 (98.0°C)			see parameters	see parameters	R
11019	ADR_MOD_STATUS_CURRENT_FAN_SPEED → Fan coil unit regulation type status 1=fan coil unit set to speed 1 2=fan coil unit set to speed 2 3=fan coil unit set to speed 3			1	3	R
11020	ADR_MOD_STATUS_TOTALHOURSFAN → Hours of operation performed by the fan coil unit (only if parameter $I51$ is not equal to 0; otherwise the reading is always 0)			0	9999	R
11021	ADR_MOD_STATUS_CURRENT_ALARM → Alarm status bit 0 of value = 0 no frost alarm, bit 0 of value = 1 frost alarm bit 1 of value = 0 no alarm on DI1, bit 1 of value = 1 alarm on DI1 (with $I87=6$) bit 2 of value = 0 no alarm on DI2, bit 2 of value = 1 alarm on DI2 (with $I89=6$) bit 3 of value = 0 no alarm on AI1 used, bit 3 of value = 1 alarm on AI1 (with $I11=9$) bit 4 of value = 0 no alarm on AI2 used, bit 4 of value = 1 alarm on AI2 (with $I13=9$)			0	31	R
11022	ADR_MOD_STATUS_FILTER_DIRTY → Fan filter status 0 = no filter alarm (working hours of fan < $I51$) 1 = filter alarm (working hours of fan >= $I51$)			0	1	R
11023	ADR_MOD_STATUS_CURRENT_POS_VALVE_3PT_HEATING → Position of the 3-point heating valve 0=0% valve closed and 1000=100.0% valve opening percentage (x10)		0	0	1000	R

Address	Description	Par	Def	Min	Max	R/W
11024	ADR_MOD_STATUS_CURRENT_POS_VALVE_3PT_COOLING → Position of the 3-point cooling valve 0=0% valve closed and 1000=100.0% valve opening percentage (x10)		0	0	1000	R
11025	ADR_MOD_STATUS_CURRENT_ON_OFF → THS2-0MM on/off status 0=OFF 1=ON			0	1	R
11026	ADR_MOD_STATUS_CURRENT_ECONOMY → Economy mode status 0=no economy 1=economy 2=economy outside time bands (send by THS2 if current time outside bands with $M1B=0$)			0	2	R
11027	ADR_MOD_STATUS_CURRENT_HOLIDAY → Unoccupied holidays mode status 0=no unoccupied holidays mode 1=unoccupied holidays mode 2=unoccupied holidays selected manually from keyboard of THS2			0	2	R
11028	ADR_MOD_STATUS_CURRENT_MASTERSTA → Current operating season status 0=2-pipe heating 1=2-pipe cooling 2=heating during cooling season with mid-season mode ($M1B=1$) 3=4-pipe heating 4=4-pipe cooling 5=season undefined (in 2-pipe mode) 6=season undefined when the internal network is switched on (2-pipe mode)			0	6	R
11029	ADR_MOD_STATUS_CURRENT_FORCE_COMFORT → Comfort mode status selected from keyboard of THS2 0=no comfort mode 2=comfort mode			0	2	R
11030	ADR_MOD_STATUS_CURRENT_WINDOW → Window status position 0=window open 1=window closed			0	1	R
11031	ADR_MOD_STATUS_STATUS_CURRENT_MINTHERM → Minimum thermostat position 0=minimum thermostat open 1=minimum thermostat closed			0	1	R
11032	ADR_MOD_STATUS_CURRENT_OFFSET_VARIATOR → Value of current offset variator multiplied by 10 (°C) -100=-10.0°C / 100=10.0°C			-100	100	R
11033	STATUS_PRESENCE_SUPERVISOR_DISPLAY → Status of presence of THS2 or supervisor connection 0=external Modbus port not connected 11111=THS2 connected on external Modbus port 11500=THS2 connected on external Modbus port (internal temp, humidity not sent) 22222=supervisor connected on external Modbus port			0	22222	R
11034	ADR_MOD_STATUS_CURRENT_THS2_TEMP → Temperature detected by THS2 (with correction $M1B$ included) multiplied by 10 -200=value in case external Modbus port not connected, the value can't be set			-200	970	R/W
11035	ADR_MOD_STATUS_CURRENT_THS2_HUM → Humidity detected by THS2 (with correction $M1B$ included) multiplied by 10 0=0% RH, 1000=100.0% RH			0	1000	R/W
11036	ADR_MOD_STATUS_CURRENT_TRASM_HUM → Current humidity level of transmitter connected to internal network, multiplied by 10 (based on $M21$ → transmitter presence). If $M21=0$: the reading is 0 If $M21=1$: the reading is between 0 (0% RH) and 1000 (100.0% RH) If there is a communication problem with the transmitter, the reading is forced to 0			0	1000	R
11037	ADR_MOD_STATUS_CURRENT_TRASM_CO2 → Current level of CO ₂ of transmitter connected to internal network (based on $M21$ → transmitter presence). If $M21=0$: the reading is 0 If $M21=1$: the reading is between 0 (0 ppm) and 2000 (2000 ppm) If there is a communication problem with the transmitter, the reading is forced to 0			0	2000	R
11038	Reserved			0	5555	R
11039	ADR_MOD_FORCE_ECONOMY → Force economy mode 200=forced value not considered 0= force no economy 1= force economy 2= force economy outside time bands(not considered if a digital or analogue input is set as economy contact)		200	0	2	R/W
11040	ADR_MOD_FORCE_HOLIDAY → Force unoccupied holidays mode 200=forced value not considered 0= force no unoccupied holidays mode 1= force unoccupied holidays mode 2= force unoccupied holidays keyboard (not considered if a digital or analogue input is set as economy contact)		200	0	2	R/W

Address	Description	Par	Def	Min	Max	R/W
11041	ADR_MOD_FORCE_STA → Force current operating season (2-pipe only) 200=forced value not considered 0= force 2-pipe heating 1= force 2-pipe cooling		200	0	1	R/W
11042	Reserved address					R
11043	ADR_MOD_FORCE_WINDOW → Force window position 200=forced value not considered 0= force window open 1= force window closed		200	0	1	R/W
11044	ADR_MOD_FORCE_MINTHERM → Force minimum thermostat 200=forced value not considered 0= force minimum thermostat open 1= force minimum thermostat closed		200	0	1	R/W
11045	ADR_MOD_FORCE_OFFSET_VARIATOR → Force value of offset variator multiplied by 10 (°C) 200=forced value not considered -100=-10.0°C / 100=10.0°C		200	-100	100	R/W
11046	ADR_MOD_FORCE_TRASM_HUM → Force humidity level of virtual transmitter connected to internal network, multiplied by 10 -200=forced value not considered 0 (0% RH)..1000 (100.0% RH)=force value considered		-200	0	1000	R/W
11047	ADR_MOD_FORCE_TRASM_CO2 → Force current level of CO ₂ of virtual transmitter. -200=forced value not considered 0 (0 ppm)..2000 (2000 ppm)=force value considered		-200	0	2000	R/W
11048	ADR_MOD_FORCE_MASTERGLOBALONOFF → On/off forced value for on/off 200=forced value not considered 0=forced to off 1=forced to on		200	0	1	R/W
11049	ADR_MOD_STA_MANUAL → Operating season (2-pipe only) if no contact are defined as remote change-over 0= force 2-pipe heating 1= force 2-pipe cooling			0	1	R/W
11050	ADR_MOD_FAN_SPEED_MODE → Fan coil unit regulation type 1=fan coil unit set to speed 1 2=fan coil unit set to speed 2 3=fan coil unit set to speed 3 4=fan coil unit regulated automatically			1	4	R/W
11051	ADR_MOD_OFFSET_SETPOINT → Value of offset setpoint multiplied by 10 (°C) -1112*10..1112*10 °C			-1112 x 10	1112 x 10	R/W
11052	ADR_MOD_KEYSELECT_FORCED_OUTPUTS → Output forcing key for address variables 11053 to 11061 inclusive value between 21505 and 22015=forcing key present xxxxx=(with xxxxx not within the range between 21505 and 22015) forcing key not present			0	65535	R/W
11053	ADR_MOD_FORCE_DO1 → Force digital output 1 0=relay 1 deactivated, 1=relay 1 activated			0	1	R/W
11054	ADR_MOD_FORCE_DO2 → Force digital output 2 0=relay 1 deactivated, 1=relay 1 activated			0	1	R/W
11055	ADR_MOD_FORCE_DO3 → Force digital output 3 0=relay 1 deactivated, 1=relay 1 activated			0	1	R/W
11056	ADR_MOD_FORCE_DO4 → Force digital output 4 0=relay 1 deactivated, 1=relay 1 activated			0	1	R/W
11057	ADR_MOD_FORCE_DO5 → Force digital output 5 0=relay 1 deactivated, 1=relay 1 activated			0	1	R/W
11058	ADR_MOD_FORCE_DO6 → Force digital output 6 0=relay 1 deactivated, 1=relay 1 activated			0	1	R/W
11059	ADR_MOD_FORCE_AO1 → Force analogue output 1 0(0V)...1000(10V)			0	1000	R/W
11060	ADR_MOD_FORCE_AO2 → Force analogue output 2 0(0V)...1000(10V)			0	1000	R/W
11061	ADR_MOD_FORCE_AO3 → Force analogue output 3 0(0V)...1000(10V)			0	1000	R/W
11062	ADR_MOD_KEYSELECT_FORCED_INPUTS → Input forcing key for variables from addresses 11063 to 11066 inclusive value between 26113 and 26127=forcing key present xxxxx=(with xxx not within the range between 26113 and 26127) forcing key not present		0	0	65535	R/W
11063	ADR_MOD_FORCE_DI1 → Force digital input 1 0=contact DI1 open, 1=contact DI1 closed		0	0	1	R/W

Address	Description	Par	Def	Min	Max	R/W
11064	ADR_MOD_FORCE_DI2 → Force digital input 2 0=contact DI2 open, 1=contact DI2 closed		0	0	1	R/W
11065	ADR_MOD_FORCE_AI1 → Force analogue input 1 - temperature sensor value multiplied by 10(°C) if $I_{12} \neq 10$: forcing -200 (corresponding to -20.0°C) corresponds to open sensor AI1; the forcing of 970 (corresponding to 97.0°C) corresponds to short-circuited sensor AI1. - value between -M 15 and +M 15 (setpoint variation) multiplied by 10(°C) if $I_{12} = 10$		0	-150	900	R/W
11066	ADR_MOD_FORCE_AI2 → Forces analogue input 2 - temperature sensor value multiplied by 10(°C) if $I_{12} \neq 10$: forcing -200 (corresponding to -20.0°C) corresponds to open sensor AI2; the forcing of 970 (corresponding to 97.0°C) corresponds to short-circuited sensor AI2. - value between -M 15 and +M 15 (setpoint variation) multiplied by 10(°C) if $I_{12} = 10$		0	-150	900	R/W
11067	ADR_MOD_RESET_COM_ALARM_COUNTERS → Reset communication error counters 0=counters not resetted 1=counters resetted		0	0	1	R/W
11068	ADR_MOD_RESET_3PT_VALVES → Valve 3-point reset cycle 0=valve 3-point reset cycle not activated 1=valve 3-point reset cycle activated		0	0	1	R/W
11069	ADR_MOD_TYPEREG → Type of plant 0=2-pipe 1=4-pipe	I_{11}	0	0	1	R/W
11070	ADR_MODTYPESENSREG → Type of sensor for regulation 0=regulation with own remote sensor ($I_{11} \neq 1$ or $I_{13} = 1$) 1=regulation with supervisor temperature or internal temperature of THS2 unit [in ADR_MOD_STATUS_CURRENT_THS2_TEMP (11034) must be written the value of temperature in case of supervisor temperature] 2=regulation with remote regulation sensor of master unit of internal network	I_{12}	0	0	2	R/W
11071	ADR_MOD_TYPHEATINGCOIL → Type of heating battery (stage 1) 0=no heating battery 1=modulating electrical resistance 2=modulating valve 3=on/off electrical resistance 4=on/off or 3-point valve	I_{13}	4	0	4	R/W
11072	ADR_MOD_TYPCOOLINGCOIL → Type of cooling battery 0=no cooling battery 1=modulating valve 2=on/off or 3-point valve	I_{14}	2	0	2	R/W
11073	ADR_MOD_TYPADDCOIL → Type of supplemental battery (heating stage 2 or for mid-season operation) 0=no supplemental battery 1=on/off electrical resistance 2=modulating electrical resistance	I_{15}	0	0	2	R/W
11074	ADR_MOD_TYPFAN → Type of fan 0=non-controlled fan coil unit 1=three-speed on/off fan coil unit 2=modulating fan coil unit	I_{16}	1	0	2	R/W
11075	ADR_MOD_DIGINPUT1FUN → Function of digital input 1 0=not used 1=remote season changeover (INPUT ON=winter, INPUT OFF=summer) 2=remote On/Off (INPUT ON=OFF, INPUT OFF=ON) 3=unoccupied holidays (INPUT ON=occupied) 4=economy (INPUT ON=economy active) 5=window contact (INPUT OFF=window open) 6=alarm (INPUT ON=alarm occurrence) 7=minimum thermostat contact, fan coil unit battery fluid (INPUT ON=thermostat closed)	I_{17}	0	0	7	R/W
11076	ADR_MOD_DIGINPUT1LOG → Digital input 1 contact logic 0=normally open (open=INPUT OFF, closed=INPUT ON) 1=normally closed (closed=INPUT OFF, open=INPUT ON)	I_{18}	0	0	1	R/W
11077	ADR_MOD_DIGINPUT2FUN → Function of digital input 2r 0=not used 1=remote season changeover (INPUT ON=winter, INPUT OFF=summer) 2=remote On/Off (INPUT ON=OFF, INPUT OFF=ON) 3=unoccupied holidays (INPUT ON=occupied) 4=economy (INPUT ON=economy active) 5=window contact (INPUT OFF=window open) 6=alarm (INPUT ON=alarm occurrence) 7=minimum thermostat contact, fan coil unit battery fluid (INPUT ON=thermostat closed)	I_{19}	0	0	7	R/W
11078	ADR_MOD_DIGINPUT2LOG → Digital input 2 contact logic 0=normally open (open=INPUT OFF, closed=INPUT ON) 1=normally closed (closed=INPUT OFF, open=INPUT ON)	I_{20}	0	0	1	R/W

Address	Description	Par	Def	Min	Max	R/W
11079	ADR_MOD_ANAINPUT1FUN → Function of analogue input 1 0=not used 1=remote regulation sensor 2=water sensor for automatic season changeover 3=minimum thermostat sensor (fan coil unit battery fluid) 4=remote contact for season changeover (INPUT ON=winter, INPUT OFF=summer) 5=remote on/off (INPUT ON=OFF, INPUT OFF=ON) 6=unoccupied holidays (INPUT ON=occupied) 7=economy (INPUT ON=economy active) 8=window contact (INPUT OFF=window open) 9=alarm (INPUT ON=alarm occurrence) 10=remote setpoint variator	I 11	1	0	10	R/W
11080	ADR_MOD_ANAINPUT1LOG → Analogue input 1 logic (only with I 11=4 to 10) 0=normally open (open=INPUT OFF, closed=INPUT ON) 1=normally closed (closed=INPUT OFF, open=INPUT ON)	I 12	0	0	1	R/W
11081	ADR_MOD_ANAINPUT2FUN → Function of analogue input 2 0=not used 1=remote regulation sensor 2=water sensor for automatic season changeover 3=minimum thermostat sensor (fan coil unit battery fluid) 4=remote contact for season changeover (INPUT ON=winter, INPUT OFF=summer) 5=remote on/off (INPUT ON=OFF, INPUT OFF=ON) 6=unoccupied holidays (INPUT ON=occupied) 7=economy (INPUT ON=economy active) 8=window contact (INPUT OFF=window open) 9=alarm (INPUT ON=alarm occurrence) 10=remote setpoint variator	I 13	0	0	10	R/W
11082	ADR_MOD_ANAINPUT2LOG → Analogue input 2 logic (only with I 13=4 to 10) 0=normally open (open=INPUT OFF, closed=INPUT ON) 1=normally closed (closed=INPUT OFF, open=INPUT ON)	I 14	0	0	1	R/W
11083	ADR_MOD_DIGOUTPUT1FUNC → Function of digital output 1 0=not used 1=on/off fan speed 1 2=on/off fan speed 2 3=on/off fan speed 3 4=heating valve 5=cooling valve 6=mixed-use valve 7=electrical resistance stage 1 8=electrical resistance stage 2 or for mid-season 9=relay for EC motor 10=pump 11=CO ₂ damper 12=dehumidifier based on internal humidity sensor of THS2 13=dehumidifier based on remote humidity value of transmitter connected to internal network 14=alarm 15=3-point heating valve: opening 16=3-point heating valve: closure 17=3-point cooling valve: opening 18=3-point cooling valve: closure 19=3-point mixed-use valve: opening 20=3-point mixed-use valve: closure	I 15	1	0	20	R/W
11084	ADR_MOD_DIGOUTPUT2FUNC → Function of digital output 2 0=not used 1=on/off fan speed 1 2=on/off fan speed 2 3=on/off fan speed 3 4=heating valve 5=cooling valve 6=mixed-use valve 7=electrical resistance stage 1 8=electrical resistance stage 2 or for mid-season 9=relay for EC motor 10=pump 11=CO ₂ damper 12=dehumidifier based on internal humidity sensor of THS2 13=dehumidifier based on remote humidity value of transmitter connected to internal network 14=alarm 15=3-point heating valve: opening 16=3-point heating valve: closure 17=3-point cooling valve: opening 18=3-point cooling valve: closure 19=3-point mixed-use valve: opening 20=3-point mixed-use valve: closure	I 16	2	0	20	R/W

Address	Description	Par	Def	Min	Max	R/W
11085	ADR_MOD_DIGOUTPUT3FUNC → Function of digital output 3 0=not used 1=on/off fan speed 1 2=on/off fan speed 2 3=on/off fan speed 3 4=heating valve 5=cooling valve 6=mixed-use valve 7=electrical resistance stage 1 8=electrical resistance stage 2 or for mid-season 9=relay for EC motor 10=pump 11=CO ₂ damper 12=dehumidifier based on internal humidity sensor of THS2 13=dehumidifier based on remote humidity value of transmitter connected to internal network 14=alarm 15=3-point heating valve: opening 16=3-point heating valve: closure 17=3-point cooling valve: opening 18=3-point cooling valve: closure 19=3-point mixed-use valve: opening 20=3-point mixed-use valve: closure	I 17	3	0	20	R/W
11086	ADR_MOD_DIGOUTPUT4FUNC → Function of digital output 4 0=not used 1=on/off fan speed 1 2=on/off fan speed 2 3=on/off fan speed 3 4=heating valve 5=cooling valve 6=mixed-use valve 7=electrical resistance stage 1 8=electrical resistance stage 2 or for mid-season 9=relay for EC motor 10=pump 11=CO ₂ damper 12=dehumidifier based on internal humidity sensor of THS2 13=dehumidifier based on remote humidity value of transmitter connected to internal network 14=alarm	I 18	0	0	14	R/W
11087	ADR_MOD_DIGOUTPUT5FUNC → Function of digital output 5 0=not used 1=on/off fan speed 1 2=on/off fan speed 2 3=on/off fan speed 3 4=heating valve 5=cooling valve 6=mixed-use valve 7=electrical resistance stage 1 8=electrical resistance stage 2 or for mid-season 9=relay for EC motor 10=pump 11=CO ₂ damper 12=dehumidifier based on internal humidity sensor of THS2 13=dehumidifier based on remote humidity value of transmitter connected to internal network 14=alarm 15=3-point heating valve: opening 16=3-point heating valve: closure 17=3-point cooling valve: opening 18=3-point cooling valve: closure 19=3-point mixed-use valve: opening 20=3-point mixed-use valve: closure	I 19	6	0	20	R/W

Address	Description	Par	Def	Min	Max	R/W
11088	ADR_MOD_DIGOUTPUT6FUNC → Function of digital output 6 0=not used 1=on/off fan speed 1 2=on/off fan speed 2 3=on/off fan speed 3 4=heating valve 5=cooling valve 6=mixed-use valve 7=electrical resistance stage 1 8=electrical resistance stage 2 or for mid-season 9=relay for EC motor 10=pump 11=CO ₂ damper 12=dehumidifier based on internal humidity sensor of THS2 13=dehumidifier based on remote humidity value of transmitter connected to internal network 14=alarm 15=3-point heating valve: opening 16=3-point heating valve: closure 17=3-point cooling valve: opening 18=3-point cooling valve: closure 19=3-point mixed-use valve: opening 20=3-point mixed-use valve: closure	I20	0	0	20	R/W
11089	ADR_MOD_ANAOUTPUT1FUNC → Function of analogue output 1 0=not used 1=EC fan output 2=heating valve output for 2-pipe or 4-pipe systems 3=cooling valve output for 2-pipe or 4-pipe systems 4=mixed-use valve output for 2-pipe systems 5=modulating CO ₂ damper output 6=modulating dehumidifier based on internal humidity sensor of THS2 7=modulating dehumidifier based on humidity transmitter connected to internal network 8=stage 1 modulating electrical resistance 9=stage 2 or mid-season modulating electrical resistance	I21	0	0	9	R/W
11090	ADR_MOD_ANAOUTPUT2FUNC → Function of analogue output 2 0=not used 1=EC fan output 2=heating valve output for 2-pipe or 4-pipe systems 3=cooling valve output for 2-pipe or 4-pipe systems 4=mixed-use valve output for 2-pipe systems 5=modulating CO ₂ damper output 6=modulating dehumidifier based on internal humidity sensor of THS2 7=modulating dehumidifier based on humidity transmitter connected to internal network 8=stage 1 modulating electrical resistance 9=stage 2 or mid-season modulating electrical resistance	I22	0	0	9	R/W
11091	ADR_MOD_ANAOUTPUT3FUNC → Function of analogue output 3 0=not used 1=EC fan output 2=heating valve output for 2-pipe or 4-pipe systems 3=cooling valve output for 2-pipe or 4-pipe systems 4=mixed-use valve output for 2-pipe systems 5=modulating CO ₂ damper output 6=modulating dehumidifier based on internal humidity sensor of THS2 7=modulating dehumidifier based on humidity transmitter connected to internal network 8=stage 1 modulating electrical resistance 9=stage 2 or mid-season modulating electrical resistance	I23	0	0	9	R/W
11092	ADR_MOD_CORREMAI1 → Temperature correction for sensor AI1 (°C) multiplied by 10 Correction parameter I24 is added to the temperature read by remote sensor AI1	I24	0	-50	50	R/W
11093	ADR_MOD_CORREMAI2 → Temperature correction for sensor AI2 (°C) multiplied by 10 Correction parameter I25 is added to the temperature read by remote sensor AI2	I25	0	-50	50	R/W
11094	ADR_MOD_WEIGHTREMAISENS → Weighting (%) of the remote control sensor compared to the internal sensor of the THS2 unit or supervisor sensor to form the regulation sensor (I02=0 or 2) I26=0 → internal sensor of the THS2 unit or supervisor sensor used as regulation sensor I26=100 → remote sensor used as regulation sensor I26=Y → remote sensor (TA1) and internal sensor of the THS2 unit or supervisor sensor (Ti) used in combination to form the regulation sensor. The following formula is applied: Treg=[Ti (100 - Y) + (TA1 x Y)] / 100 Sensor AI1 or AI2 must be configured as remote regulation sensors; otherwise parameter I26 is not taken into account.	I26	100	0	100	R/W
11095	ADR_MOD_PROPBANDHEAT → Heating regulation proportional band (°C) multiplied by 10	I27	20	10	50	R/W
11096	ADR_MOD_INTEGRALTIMEHEAT → Integral heating regulation time (s). Parameter can be used to regulate 0..10 V modulating valve If I28=0, integral action is excluded.	I28	0	0	999	R/W

Address	Description	Par	Def	Min	Max	R/W
11097	ADR_MOD_PROPBANDCOOL → cooling regulation proportional band (°C) multiplied by 10	I29	20	10	50	R/W
11098	ADR_MOD_INTEGRALTIMECOOL → Integral cooling regulation time (s). Parameter can be used to regulate 0..10 V modulating valve If I30=0, integral action is excluded.	I30	0	0	999	R/W
11099	ADR_MOD_HYSTHEAT → Hysteresis for on/off heating output (°C) multiplied by 10	I31	10	2	20	R/W
11100	ADR_MOD_HYSTCOOL → Hysteresis for on/off cooling output (°C) multiplied by 10	I32	10	2	20	R/W
11101	ADR_MOD_DIFFSTAGES → Differential between stages (°C) multiplied by 10	I33	20	0	30	R/W
11102	ADR_MOD_HYSTSPEEDONOFF → On/off speed hysteresis (°C) multiplied by 10 Defines the hysteresis between activation and deactivation of the same speed	I34	2	2	20	R/W
11103	ADR_MOD_DIFFSPEED12ONOFF → Differential between on/off speeds 1 and 2 (°C) multiplied by 10 Defines the hysteresis between the activation of speeds 1 and 2	I35	2	2	20	R/W
11104	ADR_MOD_DIFFSPEED23ONOFF → Differential between on/off speeds 2 and 3 (°C) multiplied by 10 Defines the hysteresis between the activation of speeds 2 and 3	I36	2	2	20	R/W
11105	ADR_MOD_MINVOLTAFANEC → Minimum EC motor starting voltage (see ventilation operation)	I37	0	0	I38 * 10	R/W
11106	ADR_MOD_MAXVOLTAFANEC → Maximum voltage applicable to EC motor (see ventilation operation)	I38	100	I37 * 10	100	R/W
11107	ADR_MOD_SWITCHAFANEC → EC motor starting point during regulation (% valve regulation). Speed 1 activation threshold, EC or 3-speed motor with modulating regulation Allows the fan to start, only if the valve has reached a minimum percentage opening that is equal to parameter I39 (see ventilation operation)	I39	10	0	100	R/W
11108	ADR_MOD_BPFANEC → EC fan coil unit proportional band (°C) multiplied by 10	I40	20	10	40	R/W
11109	ADR_MOD_SPEED1AFANEC → EC motor speed 1 (% del range I38 - I37) . 0% corresponds to I37 100% corresponds to I38 (see ventilation operation)	I41	10	0	100	R/W
11110	ADR_MOD_SPEED2AFANEC → EC motor speed 2 (% of range I38 - I37) . Speed 2 activation threshold for EC and 3-speed motor with modulating regulation 0% corresponds to I37 100% corresponds to I38 (see ventilation operation)	I42	65	0	100	R/W
11111	ADR_MOD_SPEED3AFANEC → EC motor speed 3 (% of range I38 - I37). Speed 3 activation threshold for EC and 3-speed motor with modulating regulation 0% corresponds to I37 100% corresponds to I38 (see ventilation operation)	I43	100	0	100	R/W
11112	ADR_MOD_FANSTARTDELAY → Fan start delay after valve opening(s) Facilitates the prevention of annoying ventilation (too cold in winter or too hot in summer) by allowing the battery to warm up or cool down sufficiently before the fan starts.	I44	0	0	600	R/W
11113	ADR_MOD_FANSTOPDELAY → Ventilation shutdown delay(s) (can be used only if electrical resistance is active) Specifies the minimum fan maintenance delay after deactivation of the electrical resistance in order to avoid overheating the electrical resistor.	I45	30	0	600	R/W
11114	ADR_MOD_FANBOOST → Fan boost Allows specification of the fan coil unit start-up during regulation 0=ventilation start-up at desired speed 1=ventilation start-up at maximum speed for 1 s before switching to the desired speed	I46	1	0	1	R/W
11115	ADR_MOD_MINFANSPEEDREGOFF → Speed maintained when setpoint is reached Allows speed 1 to be maintained in the absence of season-based regulation. 0=fan coil unit stopped when setpoint is reached 1=fan coil unit at speed 1 when setpoint is reached 2=fan coil unit at speed 1 when cooling only setpoint is reached 3=fan coil unit at speed 1 when heating only setpoint is reached 4=fan coil unit at selected manual speed when setpoint is reached 5=fan coil unit at selected manual speed when cooling only setpoint is reached 6=fan coil unit at selected manual speed when heating only setpoint is reached	I47	0	0	6	R/W
11116	ADR_MOD_AIRDESTRATFUNC → Air destratification function Defines whether to start the fan coil unit at minimum speed in the absence of regulation to avoid air stratification when the regulation sensor is mounted on the fan coil unit intake. 0=Off 1=On 2=On only in heating mode 3=On only in cooling mode	I48	1	0	3	R/W
11117	ADR_MOD_TIMECYCLEDESTRATON → Fan coil unit start-up time during destratification cycle (minutes)	I49	1	1	5	R/W
11118	ADR_MOD_TIMECYCLEDESTRATOFF → Fan coil unit downtime in the absence of regulation before implementing a new destratification cycle (minutes)	I50	10	1	60	R/W

Address	Description	Par	Def	Min	Max	R/W	
11119	ADR_MOD_MAXHOURSFANFILTERDIRTY → Maximum fan coil unit operating time before the filter is considered to be dirty (hours) 0=function not used X=maximum hours of fan operation before a message appears on the display.	I51	2000	0	9990	R/W	
11120	ADR_MOD_TIMEVALVE3POINTS → Valve stroke time for 3-point regulation (seconds)	I52	60	30	180	R/W	
11121	ADR_MOD_CANCELHOURSFAN → Reset of the counter of operating hours of fan coil unit. The hours of fan coil unit operation are stored in memory. When they exceed I51, the  icon appears. To clear the counter, input I53=1. Automatically switches the parameter to 0 after resetting	I53	0	0	1	R/W	
11122	ADR_MOD_BASICHEATSET → Heating setpoint for 2-pipe regulation (°C) multiplied by 10 (205=20.5°C), with step 5 (0.5°C)	E01	200	E05 * 10	E04 * 10	R/W	
11123	ADR_MOD_BASICCOOLSET → Cooling setpoint for 2-pipe regulation (°C) multiplied by 10 (250=25.0°C), with step 5 (0.5°C)	E02	250	E07 * 10	E06 * 10	R/W	
11124	ADR_MOD_BASICSET4PIPE → Setpoint for 4-pipe regulation (°C) multiplied by 10 (210=21.0°C), with step 5 (0.5°C)	E03	210	E05 * 10	E04 * 10	R/W	
11125	ADR_MOD_LIMITUPSETHEAT → Maximum limit of heating regulation setpoints (°C) multiplied by 10 (400=40.0°C), with step 5 (0.5°C) Limits the maximum value of the E01 and E03 setpoints	E04	400	E05 * 10	500	R/W	
11126	ADR_MOD_LIMITDOWNSETHEAT → Minimum limit of heating regulation setpoints (°C) multiplied by 10 (60=6.0°C), with step 5 (0.5°C) Limits the minimum value of setpoints E01 and E03	E05	60	60	E04 * 10	R/W	
11127	ADR_MOD_LIMITUPSETCOOL → Maximum limit of cooling regulation setpoint (°C) multiplied by 10 (400=40.0°C), with step 5 (0.5°C) Limits the maximum value of the E02 setpoint.	E06	400	E07 * 10	500	R/W	
11128	ADR_MOD_LIMITDOWNSETCOOL → Minimum limit of cooling regulation setpoint (°C) multiplied by 10 (60=6.0°C), with step 5 (0.5°C). Limits the minimum value of the E02 setpoint.	E07	60	60	E06 * 10	R/W	
11129	ADR_MOD_ECOSSETADJUST → Economy offset (°C) multiplied by 10 with step 5 (0.5°C) In economy mode, the cooling working setpoint is increased by E08 In economy mode, the heating working setpoint is decreased by E08	E08	30	0	60	R/W	
11130	ADR_MOD_HOLSETADJUST → "Unoccupied holidays" (°C) economy offset mode of operation multiplied by 10 with step 5 (0.5°C) In "unoccupied holidays" mode, the cooling working setpoint is increased by E09 In "unoccupied holidays" mode, the heating working setpoint is decreased by E09	E09	50	0	140	R/W	
11131	ADR_MOD_DEADZONE → Neutral zone for 4-pipe systems (°C) multiplied by 10	E10	5	5	50	R/W	
11132	ADR_MOD_DIFFINSERTHALFSEASON → Differential insertion heating during summer (mid-season) (°C) multiplied by 10	E11	30	5	100	R/W	
11133	ADR_MOD_FROSTSET → Frost protection setpoint (°C) multiplied by 10 with step 5 (0.5°C)	E12	50	40	100	R/W	
11134	ADR_MOD_WINTERSETCO → Heating setpoint for automatic season changeover sensor (water sensor) (°C) multiplied by 10 with step 5 (0.5°C)	E13	280	260	400	R/W	
11135	ADR_MOD_SUMMERSETCO → Cooling setpoint for automatic season changeover sensor (water sensor) (°C) multiplied by 10 with step 5 (0.5°C)	E14	170	100	250	R/W	
11136	ADR_MOD_MINTHERMSET → Minimum thermostat setpoint (°C) (hysteresis fixed at 2°C) multiplied by 10 with step 5 (0.5°C) (see "23. Minimum thermostat" page 48)	E15	210	190	500	R/W	
11137	ADR_MOD_SEASONINBETWEENSUMWIN → Season selection in 2-pipe systems with water sensor temperature of between E14 and E13 (see paragraph "9. Automatic season changeover with water sensor" page 20) 0=heating (at power-on) 1=cooling (at power-on) 2=season not defined, regulation stopped	E16	0	0	2	R/W	
11138	ADR_MOD_CO2SET → IAQ air exchange setpoint (ppm)	E17	800	0	2000	R/W	
11139	ADR_MOD_PROPBANDCO2 → Proportional band or IAQ hysteresis (ppm)	E18	200	50	500	R/W	
11140	ADR_MOD_MINDAMPEROPENING → Minimum modulating damper opening for IAQ (%)	E19	10	0	100	R/W	
11141	ADR_MOD_HUMSET → Humidity setpoint for dehumidification (% RH) multiplied by 10 with step 5 (0.5% RH)	E20	500	50	1000	R/W	
11142	ADR_MOD_PROPBANDHUM → Proportional band or humidity hysteresis by dehumidification (% RH) multiplied by 10	E21	50	20	1000	R/W	
11143	Reserved address						R
11144	ADR_MOD_OFFSETRANGE → Setpoint offset range applied in the comfort mode (°C) or to the remote setpoint variator SAP-NTC20-02-2-EV. Defines the extent to which the setpoint can vary in comfort mode or the remote setpoint variator can vary.	M12	60	0	100	R/W	

Address	Description	Par	Def	Min	Max	R/W
11145	ADR_MOD_ACTIVEHALFSEASON → Activation of mid-season function 0=mid-season mode not activated 1=mid-season mode activated. In cooling mode, it is possible to heat with electrical resistance, if the temperature drops too far below the setpoint (see mid-season operation)	M1B	0	0	1	R/W
11146	Reserved address					
11147	ADR_MOD_MODBUS_BAUDEXT → Baud rate of external Modbus network (towards supervisor or THS2 in CN5) 3=9600 bit/s 4=19200 bit/s 5=38400 bit/s	M17	4	3	5	R/W
11148	ADR_MOD_MODBUS_PARITYEXT → External Modbus network parity (towards supervisor or THS2 in CN5) 0=none 1=odd 2=even	M1B	2	0	2	R/W
11149	ADR_MOD_MODBUS_ADDRESS_NETWORK → Address of THS2-0MM in the external Modbus network (towards supervisor or THS2 in CN5) when jumper J2=ON and SW3≠0 -> Address of THS2-0MM in the external and internal Modbus network when jumper J2=ON and SW3=0 1..247=valid address 248=not valid address	M19	1	1	248	R/W
11150	ADR_MOD_MAX_UNITS_INTERNAL_NETWORK → Maximum number of THS2-0MM (master + slaves) connected together in the internal network (optional transmitter excluded)	M20	1	1	15	R/W
11151	ADR_MOD_PRESENCE_TRANSMITTER → Presence of a transmitter in the internal network 0=no transmitter connected to internal network 1=humidity, CO ₂ transmitter connected to internal network	M21	0	0	1	R/W
11152	Reserved address					R
11153	ADR_MOD_RESET_PARAM_TO_DEFAULT → Select parameters to set to default values 0=no parameters set to the default value 1=all parameters set to default values except parameters of communication M17, M1B, M19	R01		0	1	R/W
11154 to 11195	Reserved address					R
11196	ADR_MOD_STATUS_COMMUNICATION → Status communication on internal network between THS2-0MM master and THS2-0MM slave. This address is not considered by master. This address can be read on each THS2-0MM slave to know if communication takes place with master. 0=not considered (by THS2-0MM master unit on internal network) 1=messages are exchanged on internal network between master and slave 2=no communication on internal network with between master and slave			0	2	R
11197	ADR_MOD_ADDRESS_INTERNAL_NETWORK → Address set on rotary switch in internal network 0=not valid address 1..9, 10(A), 11(B), 12(C),13(D), 14(E), 15(F)=valid address			0	15	R
11198	ADR_MOD_SOFTWARE_VERSION → Software version THS2-0MM (single variable) if value=z the corresponding software version is 0.0.z if value=yz the corresponding software version is 0.y.z if value=xyz the corresponding software version is x.y.z	UB4		0	999	R
11199	ADR_MOD_UNIT → Unit 0=°C (cannot be changed)			0	0	R
	Variables below can be different from 0 only for THS2-0MM master					
11200	ADR_MOD_READ_STATUS_AI1_ADR_1 Variable similar to ADR_MOD_STATUS_AI1 for THS2-0MM with internal address = 1			-200	900	R
11201	ADR_MOD_READ_STATUS_AI2_ADR_1 Variable similar to ADR_MOD_STATUS_AI2 for THS2-0MM with internal address = 1			-200	900	R
11202	ADR_MOD_READ_STATUS_WORKING_TEMP_ADR_1 Variable similar to ADR_MOD_STATUS_CURRENT_WORKING_TEMP for THS2-0MM with internal address = 1.			-150	900	R
11203	ADR_MOD_READ_STATUS_WORKING_SET_HEAT_ADR_1 Variable similar to ADR_MOD_STATUS_WORKING_SET_HEAT for THS2-0MM with internal address = 1.			see parameters	see parameters	R
11204	ADR_MOD_READ_STATUS_WORKING_SET_COOL_ADR_1 Variable similar to ADR_MOD_STATUS_WORKING_SET_COOL for THS2-0MM with internal address = 1.			see parameters	see parameters	R
11205	ADR_MOD_READ_STATUS_FAN_SPEED_ADR_1 Variable similar to ADR_MOD_STATUS_CURRENT_FAN_SPEED for THS2-0MM with internal address = 1.			1	3	R

Address	Description	Par	Def	Min	Max	R/W
11206	ADR_MOD_READ_STATUS_TOTALHOURS_FAN_ADR_1 Variable similar to ADR_MOD_STATUS_TOTALHOURS_FAN for THS2-0MM with internal address = 1.			0	9999	R
11207	ADR_MOD_READ_STATUS_ALARM_ADR_1 Alarm status for THS2-0MM with address = 1 bit 0 of value = 0 no frost alarm, bit 0 of value = 1 frost alarm bit 1 of value = 0 no alarm on DI1, bit 1 of value = 1 alarm on DI1 (with I07=6) bit 2 of value = 0 no alarm on DI2, bit 2 of value = 1 alarm on DI2 (with I09=6) bit 3 of value = 0 no alarm on AI1 used, bit 3 of value = 1 alarm on AI1 (with I11=9) bit 4 of value = 0 no alarm on AI2 used, bit 4 of value = 1 alarm on AI2 (with I13=9) bit 5 of value = 0 filter not dirty, bit 5 of value = 1 filter dirty.			0	31	R
11208	ADR_MOD_READ_WORK_TEMP_THS2_ADR_1 → Working temperature multiplied by 10 (°C) for THS2-0MM with address = 1 in case I02=1 only. The reading is -200 (corresponding to -20.0°C) in case value not considered or I02≠1			-200	900	R
11209	ADR_MOD_READ_WORK_HUM_THS2_ADR_1 → Working humidity multiplied by 10 (°C) for THS2-0MM with address = 1 in case internal humidity sensor of THS2 is used. The reading is 0 (corresponding to 0%r.h) in case value not considered.			0	1000	R
11210	ADR_MOD_READ_STATUS_ON_OFF_ADR_1 Variable similar to ADR_MOD_STATUS_CURRENT_ON_OFF for THS2-0MM with internal address = 1.			0	1	R
11211	ADR_MOD_READ_STATUS_CPT_TIMEOUT_COM_ADR_1 → Communication timeout counter between master and THS2-0MM with address = 1	Ct 1		0	9999	R
11212	ADR_MOD_READ_STATUS_CPT_ERR_DATA_COM_ADR_1 → Data error counter or incorrect addressing between master and slave = 1	Cr 1		0	9999	R
11213	ADR_MOD_READ_SPEED_REQUIRED_1 Variable similar to ADR_MOD_FAN_SPEED_MODE for THS2-0MM with internal address = 1			1	4	R
11214	ADR_MOD_READ_SPEED_OFFSET_1 Variable similar to ADR_MOD_OFFSET_SETPOINT for THS2-0MM with internal address = 1			-M12	M12	R
11215	ADR_MOD_READ_SET_USED_1 Variable similar to ADR_MOD_BASICHEATSET or ADR_MOD_BASICCOOLSET in 2-pipe system based on working season or ADR_MOD_BASICSET4PIPE in 4-pipe system, for THS2-0MM with internal address = 1			see variable similar	see variable similar	R
11216	ADR_MOD_READ_PRESENCE_DISPLAY_SUPERV_1 0=external Modbus port not connected 11111=THS2 connected on external Modbus port 11500=THS2 connected on external Modbus port (internal temp, humidity not sent) 22222=supervisor connected on external Modbus port			0	22222	
11217	ADR_MOD_READ_STATUS_AI1_ADR_2 Variable similar to ADR_MOD_STATUS_AI1 for THS2-0MM with internal address = 2			-200	900	R
11218	ADR_MOD_READ_STATUS_AI2_ADR_2 Variable similar to ADR_MOD_STATUS_AI2 for THS2-0MM with internal address = 2			-200	900	R
11219	ADR_MOD_READ_STATUS_WORKING_TEMP_ADR_2 Variable similar to ADR_MOD_STATUS_CURRENT_WORKING_TEMP for THS2-0MM with internal address = 2.			-150	900	R
11220	ADR_MOD_READ_STATUS_WORKING_SET_HEAT_ADR_2 Variable similar to ADR_MOD_STATUS_WORKING_SET_HEAT for THS2-0MM with internal address = 2.			see parameters	see parameters	R
11221	ADR_MOD_READ_STATUS_WORKING_SET_COOL_ADR_2 Variable similar to ADR_MOD_STATUS_WORKING_SET_COOL for THS2-0MM with internal address = 2.			see parameters	see parameters	R
11222	ADR_MOD_READ_STATUS_FAN_SPEED_ADR_2 Variable similar to ADR_MOD_STATUS_CURRENT_FAN_SPEED for THS2-0MM with internal address = 2.			1	3	R
11223	ADR_MOD_READ_STATUS_TOTALHOURS_FAN_ADR_2 Variable similar to ADR_MOD_STATUS_TOTALHOURS_FAN for THS2-0MM with internal address = 2.			0	9999	R
11224	ADR_MOD_READ_STATUS_ALARM_ADR_2 Alarm status for THS2-0MM with address = 2 bit 0 of value = 0 no frost alarm, bit 0 of value = 1 frost alarm bit 1 of value = 0 no alarm on DI1, bit 1 of value = 1 alarm on DI1 (with I07=6) bit 2 of value = 0 no alarm on DI2, bit 2 of value = 1 alarm on DI2 (with I09=6) bit 3 of value = 0 no alarm on AI1 used, bit 3 of value = 1 alarm on AI1 (with I11=9) bit 4 of value = 0 no alarm on AI2 used, bit 4 of value = 1 alarm on AI2 (with I13=9) bit 5 of value = 0 filter not dirty, bit 5 of value = 1 filter dirty.			0	31	R
11225	ADR_MOD_READ_WORK_TEMP_THS2_ADR_2 → Working temperature multiplied by 10 (°C) for THS2-0MM with address = 2 in case I02=1 only. The reading is -200 (corresponding to -20.0°C) in case value not considered or I02≠1			-200	900	R

Address	Description	Par	Def	Min	Max	R/W
11226	ADR_MOD_READ_WORK_HUM_THS2_ADR_2 → Working humidity multiplied by 10 (°C) for THS2-0MM with address = 2 in case internal humidity sensor of THS2 is used. The reading is 0 (corresponding to 0%r.h) in case value not considered.			0	1000	R
11227	ADR_MOD_READ_STATUS_ON_OFF_ADR_2 Variable similar to ADR_MOD_STATUS_CURRENT_ON_OFF for THS2-0MM with internal address = 2.			0	1	R
11228	ADR_MOD_READ_STATUS_CPT_TIMEOUT_COM_ADR_2 → Communication timeout counter between master and THS2-0MM with address = 2	Ctrl2		0	9999	R
11229	ADR_MOD_READ_STATUS_CPT_ERR_DATA_COM_ADR_2 → Data error counter or incorrect addressing between master and slave = 2	Err2		0	9999	R
11230	ADR_MOD_READ_SPEED_REQUIRED_2 Variable similar to ADR_MOD_FAN_SPEED_MODE for THS2-0MM with internal address = 2			1	4	R
11231	ADR_MOD_READ_SPEED_OFFSET_2 Variable similar to ADR_MOD_OFFSET_SETPOINT for THS2-0MM with internal address = 2			-M12	M12	R
11232	ADR_MOD_READ_SET_USED_2 Variable similar to ADR_MOD_BASICHEATSET or ADR_MOD_BASICCOOLSET in 2-pipe system based on working season or ADR_MOD_BASICSET4PIPE in 4-pipe system, for THS2-0MM with internal address = 2			see variable similar	see variable similar	R
11233	ADR_MOD_READ_PRESENCE_DISPLAY_SUPERV_2 0=external Modbus port not connected 11111=THS2 connected on external Modbus port 11500=THS2 connected on external Modbus port (internal temp, humidity not sent) 22222=supervisor connected on external Modbus port			0	22222	R
11234	ADR_MOD_READ_STATUS_AI1_ADR_3 Variable similar to ADR_MOD_STATUS_AI1 for THS2-0MM with internal address = 3			-200	900	R
11235	ADR_MOD_READ_STATUS_AI2_ADR_3 Variable similar to ADR_MOD_STATUS_AI2 for THS2-0MM with internal address = 3			-200	900	R
11236	ADR_MOD_READ_STATUS_WORKING_TEMP_ADR_3 Variable similar to ADR_MOD_STATUS_CURRENT_WORKING_TEMP for THS2-0MM with internal address = 3.			-150	900	R
11237	ADR_MOD_READ_STATUS_WORKING_SET_HEAT_ADR_3 Variable similar to ADR_MOD_STATUS_WORKING_SET_HEAT for THS2-0MM with internal address = 3.			see parameters	see parameters	R
11238	ADR_MOD_READ_STATUS_WORKING_SET_COOL_ADR_3 Variable similar to ADR_MOD_STATUS_WORKING_SET_COOL for THS2-0MM with internal address = 3.			see parameters	see parameters	R
11239	ADR_MOD_READ_STATUS_FAN_SPEED_ADR_3 Variable similar to ADR_MOD_STATUS_CURRENT_FAN_SPEED for THS2-0MM with internal address = 3.			1	3	R
11240	ADR_MOD_READ_STATUS_TOTALHOURS_FAN_ADR_3 Variable similar to ADR_MOD_STATUS_TOTALHOURS_FAN for THS2-0MM with internal address = 3.			0	9999	R
11241	ADR_MOD_READ_STATUS_ALARM_ADR_3 Alarm status for THS2-0MM with address = 3 bit 0 of value = 0 no frost alarm, bit 0 of value = 1 frost alarm bit 1 of value = 0 no alarm on DI1, bit 1 of value = 1 alarm on DI1 (with I07=6) bit 2 of value = 0 no alarm on DI2, bit 2 of value = 1 alarm on DI2 (with I09=6) bit 3 of value = 0 no alarm on AI1 used, bit 3 of value = 1 alarm on AI1 (with I11=9) bit 4 of value = 0 no alarm on AI2 used, bit 4 of value = 1 alarm on AI2 (with I13=9) bit 5 of value = 0 filter not dirty, bit 5 of value = 1 filter dirty.			0	31	R
11242	ADR_MOD_READ_WORK_TEMP_THS2_ADR_3 → Working temperature multiplied by 10 (°C) for THS2-0MM with address = 3 in case I02=1 only. The reading is -200 (corresponding to -20.0°C) in case value not considered or I02≠1			-200	900	R
11243	ADR_MOD_READ_WORK_HUM_THS2_ADR_3 → Working humidity multiplied by 10 (°C) for THS2-0MM with address = 3 in case internal humidity sensor of THS2 is used. The reading is 0 (corresponding to 0%r.h) in case value not considered.			0	1000	R
11244	ADR_MOD_READ_STATUS_ON_OFF_ADR_3 Variable similar to ADR_MOD_STATUS_CURRENT_ON_OFF for THS2-0MM with internal address = 3.			0	1	R
11245	ADR_MOD_READ_STATUS_CPT_TIMEOUT_COM_ADR_3 → Communication timeout counter between master and THS2-0MM with address = 3	Ctrl3		0	9999	R
11246	ADR_MOD_READ_STATUS_CPT_ERR_DATA_COM_ADR_3 → Data error counter or incorrect addressing between master and slave = 3	Err3		0	9999	R
11247	ADR_MOD_READ_SPEED_REQUIRED_3 Variable similar to ADR_MOD_FAN_SPEED_MODE for THS2-0MM with internal address = 3			1	4	R

Address	Description	Par	Def	Min	Max	R/W
11248	ADR_MOD_READ_SPEED_OFFSET_3 Variable similar to ADR_MOD_OFFSET_SETPOINT for THS2-0MM with internal address = 3			-112	112	R
11249	ADR_MOD_READ_SET_USED_3 Variable similar to ADR_MOD_BASICHEATSET or ADR_MOD_BASICCOOLSET in 2-pipe system based on working season or ADR_MOD_BASICSET4PIPE in 4-pipe system, for THS2-0MM with internal address = 3			see variable similar	see variable similar	R
11250	ADR_MOD_READ_PRESENCE_DISPLAY_SUPERV_3 0=external Modbus port not connected 11111=THS2 connected on external Modbus port 11500=THS2 connected on external Modbus port (internal temp, humidity not sent) 22222=supervisor connected on external Modbus port			0	22222	
11251	ADR_MOD_READ_STATUS_AI1_ADR_4 Variable similar to ADR_MOD_STATUS_AI1 for THS2-0MM with internal address = 4			-200	900	R
11252	ADR_MOD_READ_STATUS_AI2_ADR_4 Variable similar to ADR_MOD_STATUS_AI2 for THS2-0MM with internal address = 4			-200	900	R
11253	ADR_MOD_READ_STATUS_WORKING_TEMP_ADR_4 Variable similar to ADR_MOD_STATUS_CURRENT_WORKING_TEMP for THS2-0MM with internal address = 4.			-150	900	R
11254	ADR_MOD_READ_STATUS_WORKING_SET_HEAT_ADR_4 Variable similar to ADR_MOD_STATUS_WORKING_SET_HEAT for THS2-0MM with internal address = 4.			see parameters	see parameters	R
11255	ADR_MOD_READ_STATUS_WORKING_SET_COOL_ADR_4 Variable similar to ADR_MOD_STATUS_WORKING_SET_COOL for THS2-0MM with internal address = 4.			see parameters	see parameters	R
11256	ADR_MOD_READ_STATUS_FAN_SPEED_ADR_4 Variable similar to ADR_MOD_STATUS_CURRENT_FAN_SPEED for THS2-0MM with internal address = 4.			1	3	R
11257	ADR_MOD_READ_STATUS_TOTALHOURS_FAN_ADR_4 Variable similar to ADR_MOD_STATUS_TOTALHOURS_FAN for THS2-0MM with internal address = 4.			0	9999	R
11258	ADR_MOD_READ_STATUS_ALARM_ADR_4 Alarm status for THS2-0MM with address = 4 bit 0 of value = 0 no frost alarm, bit 0 of value = 1 frost alarm bit 1 of value = 0 no alarm on DI1, bit 1 of value = 1 alarm on DI1 (with I17=6) bit 2 of value = 0 no alarm on DI2, bit 2 of value = 1 alarm on DI2 (with I19=6) bit 3 of value = 0 no alarm on AI1 used, bit 3 of value = 1 alarm on AI1 (with I11=9) bit 4 of value = 0 no alarm on AI2 used, bit 4 of value = 1 alarm on AI2 (with I13=9) bit 5 of value = 0 filter not dirty, bit 5 of value = 1 filter dirty.			0	31	R
11259	ADR_MOD_READ_WORK_TEMP_THS2_ADR_4 → Working temperature multiplied by 10 (°C) for THS2-0MM with address = 4 in case I12=1 only. The reading is -200 (corresponding to -20.0°C) in case value not considered or I12≠1			-200	900	R
11260	ADR_MOD_READ_WORK_HUM_THS2_ADR_4 → Working humidity multiplied by 10 (°C) for THS2-0MM with address = 4 in case internal humidity sensor of THS2 is used. The reading is 0 (corresponding to 0%r.h) in case value not considered.			0	1000	R
11261	ADR_MOD_READ_STATUS_ON_OFF_ADR_4 Variable similar to ADR_MOD_STATUS_CURRENT_ON_OFF for THS2-0MM with internal address = 4.			0	1	R
11262	ADR_MOD_READ_STATUS_CPT_TIMEOUT_COM_ADR_4 → Communication timeout counter between master and THS2-0MM with address = 4	C14		0	9999	R
11263	ADR_MOD_READ_STATUS_CPT_ERR_DATA_COM_ADR_4 → Data error counter or incorrect addressing between master and slave = 4	C14		0	9999	R
11264	ADR_MOD_READ_SPEED_REQUIRED_4 Variable similar to ADR_MOD_FAN_SPEED_MODE for THS2-0MM with internal address = 4			1	4	R
11265	ADR_MOD_READ_SPEED_OFFSET_4 Variable similar to ADR_MOD_OFFSET_SETPOINT for THS2-0MM with internal address = 4			-112	112	R
11266	ADR_MOD_READ_SET_USED_4 Variable similar to ADR_MOD_BASICHEATSET or ADR_MOD_BASICCOOLSET in 2-pipe system based on working season or ADR_MOD_BASICSET4PIPE in 4-pipe system, for THS2-0MM with internal address = 4			see variable similar	see variable similar	R
11267	ADR_MOD_READ_PRESENCE_DISPLAY_SUPERV_4 0=external Modbus port not connected 11111=THS2 connected on external Modbus port 11500=THS2 connected on external Modbus port (internal temp, humidity not sent) 22222=supervisor connected on external Modbus port			0	22222	
11268	ADR_MOD_READ_STATUS_AI1_ADR_5 Variable similar to ADR_MOD_STATUS_AI1 for THS2-0MM with internal address = 5			-200	900	R

Address	Description	Par	Def	Min	Max	R/W
11269	ADR_MOD_READ_STATUS_AI2_ADR_5 Variable similar to ADR_MOD_STATUS_AI2 for THS2-0MM with internal address = 5			-200	900	R
11270	ADR_MOD_READ_STATUS_WORKING_TEMP_ADR_5 Variable similar to ADR_MOD_STATUS_CURRENT_WORKING_TEMP for THS2-0MM with internal address = 5.			-150	900	R
11271	ADR_MOD_READ_STATUS_WORKING_SET_HEAT_ADR_5 Variable similar to ADR_MOD_STATUS_WORKING_SET_HEAT for THS2-0MM with internal address = 5.			see parameters	see parameters	R
11272	ADR_MOD_READ_STATUS_WORKING_SET_COOL_ADR_5 Variable similar to ADR_MOD_STATUS_WORKING_SET_COOL for THS2-0MM with internal address = 5.			see parameters	see parameters	R
11273	ADR_MOD_READ_STATUS_FAN_SPEED_ADR_5 Variable similar to ADR_MOD_STATUS_CURRENT_FAN_SPEED for THS2-0MM with internal address = 5.			1	3	R
11274	ADR_MOD_READ_STATUS_TOTALHOURS_FAN_ADR_5 Variable similar to ADR_MOD_STATUS_TOTALHOURS_FAN for THS2-0MM with internal address = 5.			0	9999	R
11275	ADR_MOD_READ_STATUS_ALARM_ADR_5 Alarm status for THS2-0MM with address = 5 bit 0 of value = 0 no frost alarm, bit 0 of value = 1 frost alarm bit 1 of value = 0 no alarm on DI1, bit 1 of value = 1 alarm on DI1 (with I07=6) bit 2 of value = 0 no alarm on DI2, bit 2 of value = 1 alarm on DI2 (with I09=6) bit 3 of value = 0 no alarm on AI1 used, bit 3 of value = 1 alarm on AI1 (with I11=9) bit 4 of value = 0 no alarm on AI2 used, bit 4 of value = 1 alarm on AI2 (with I13=9) bit 5 of value = 0 filter not dirty, bit 5 of value = 1 filter dirty.			0	31	R
11276	ADR_MOD_READ_WORK_TEMP_THS2_ADR_5 → Working temperature multiplied by 10 (°C) for THS2-0MM with address = 5 in case I02=1 only. The reading is -200 (corresponding to -20.0°C) in case value not considered or I02≠1			-200	900	R
11277	ADR_MOD_READ_WORK_HUM_THS2_ADR_5 → Working humidity multiplied by 10 (°C) for THS2-0MM with address = 5 in case internal humidity sensor of THS2 is used. The reading is 0 (corresponding to 0%r.h) in case value not considered.			0	1000	R
11278	ADR_MOD_READ_STATUS_ON_OFF_ADR_5 Variable similar to ADR_MOD_STATUS_CURRENT_ON_OFF for THS2-0MM with internal address = 5.			0	1	R
11279	ADR_MOD_READ_STATUS_CPT_TIMEOUT_COM_ADR_5 → Communication timeout counter between master and THS2-0MM with address = 5	Ct5		0	9999	R
11280	ADR_MOD_READ_STATUS_CPT_ERR_DATA_COM_ADR_5 → Data error counter or incorrect addressing between master and slave = 5	Cr5		0	9999	R
11281	ADR_MOD_READ_SPEED_REQUIRED_5 Variable similar to ADR_MOD_FAN_SPEED_MODE for THS2-0MM with internal address = 5			1	4	R
11282	ADR_MOD_READ_SPEED_OFFSET_5 Variable similar to ADR_MOD_OFFSET_SETPOINT for THS2-0MM with internal address = 5			-112	112	R
11283	ADR_MOD_READ_SET_USED_5 Variable similar to ADR_MOD_BASICHEATSET or ADR_MOD_BASICCOOLSET in 2-pipe system based on working season or ADR_MOD_BASICSET4PIPE in 4-pipe system, for THS2-0MM with internal address = 5			see variable similar	see variable similar	R
11284	ADR_MOD_READ_PRESENCE_DISPLAY_SUPERV_5 0=external Modbus port not connected 1111=THS2 connected on external Modbus port 11500=THS2 connected on external Modbus port (internal temp, humidity not sent) 22222=supervisor connected on external Modbus port			0	22222	
11285	ADR_MOD_READ_STATUS_AI1_ADR_6 Variable similar to ADR_MOD_STATUS_AI1 for THS2-0MM with internal address = 6			-200	900	R
11286	ADR_MOD_READ_STATUS_AI2_ADR_6 Variable similar to ADR_MOD_STATUS_AI2 for THS2-0MM with internal address = 6			-200	900	R
11287	ADR_MOD_READ_STATUS_WORKING_TEMP_ADR_6 Variable similar to ADR_MOD_STATUS_CURRENT_WORKING_TEMP for THS2-0MM with internal address = 6.			-150	900	R
11288	ADR_MOD_READ_STATUS_WORKING_SET_HEAT_ADR_6 Variable similar to ADR_MOD_STATUS_WORKING_SET_HEAT for THS2-0MM with internal address = 6.			see parameters	see parameters	R
11289	ADR_MOD_READ_STATUS_WORKING_SET_COOL_ADR_6 Variable similar to ADR_MOD_STATUS_WORKING_SET_COOL for THS2-0MM with internal address = 6.			see parameters	see parameters	R
11290	ADR_MOD_READ_STATUS_FAN_SPEED_ADR_6 Variable similar to ADR_MOD_STATUS_CURRENT_FAN_SPEED for THS2-0MM with internal address = 6.			1	3	R

Address	Description	Par	Def	Min	Max	R/W
11291	ADR_MOD_READ_STATUS_TOTALHOURS_FAN_ADR_6 Variable similar to ADR_MOD_STATUS_TOTALHOURS_FAN for THS2-0MM with internal address = 6.			0	9999	R
11292	ADR_MOD_READ_STATUS_ALARM_ADR_6 Alarm status for THS2-0MM with address = 6 bit 0 of value = 0 no frost alarm, bit 0 of value = 1 frost alarm bit 1 of value = 0 no alarm on DI1, bit 1 of value = 1 alarm on DI1 (with I07=6) bit 2 of value = 0 no alarm on DI2, bit 2 of value = 1 alarm on DI2 (with I09=6) bit 3 of value = 0 no alarm on AI1 used, bit 3 of value = 1 alarm on AI1 (with I11=9) bit 4 of value = 0 no alarm on AI2 used, bit 4 of value = 1 alarm on AI2 (with I13=9) bit 5 of value = 0 filter not dirty, bit 5 of value = 1 filter dirty.			0	31	R
11293	ADR_MOD_READ_WORK_TEMP_THS2_ADR_6 → Working temperature multiplied by 10 (°C) for THS2-0MM with address = 6 in case I02=1 only. The reading is -200 (corresponding to -20.0°C) in case value not considered or I02≠1			-200	900	R
11294	ADR_MOD_READ_WORK_HUM_THS2_ADR_6 → Working humidity multiplied by 10 (°C) for THS2-0MM with address = 6 in case internal humidity sensor of THS2 is used. The reading is 0 (corresponding to 0%r.h) in case value not considered.			0	1000	R
11295	ADR_MOD_READ_STATUS_ON_OFF_ADR_6 Variable similar to ADR_MOD_STATUS_CURRENT_ON_OFF for THS2-0MM with internal address = 6.			0	1	R
11296	ADR_MOD_READ_STATUS_CPT_TIMEOUT_COM_ADR_6 → Communication timeout counter between master and THS2-0MM with address = 6	CLE		0	9999	R
11297	ADR_MOD_READ_STATUS_CPT_ERR_DATA_COM_ADR_6 → Data error counter or incorrect addressing between master and slave = 6	CrE		0	9999	R
11298	ADR_MOD_READ_SPEED_REQUIRED_6 Variable similar to ADR_MOD_FAN_SPEED_MODE for THS2-0MM with internal address = 6			1	4	R
11299	ADR_MOD_READ_SPEED_OFFSET_6 Variable similar to ADR_MOD_OFFSET_SETPOINT for THS2-0MM with internal address = 6			-M12	M12	R
11300	ADR_MOD_READ_SET_USED_6 Variable similar to ADR_MOD_BASICHEATSET or ADR_MOD_BASICCOOLSET in 2-pipe system based on working season or ADR_MOD_BASICSET4PIPE in 4-pipe system, for THS2-0MM with internal address = 6			see variable similar	see variable similar	R
11301	ADR_MOD_READ_PRESENCE_DISPLAY_SUPERV_6 0=external Modbus port not connected 11111=THS2 connected on external Modbus port 11500=THS2 connected on external Modbus port (internal temp, humidity not sent) 22222=supervisor connected on external Modbus port			0	22222	
11302	ADR_MOD_READ_STATUS_AI1_ADR_7 Variable similar to ADR_MOD_STATUS_AI1 for THS2-0MM with internal address = 7			-200	900	R
11303	ADR_MOD_READ_STATUS_AI2_ADR_7 Variable similar to ADR_MOD_STATUS_AI2 for THS2-0MM with internal address = 7			-200	900	R
11304	ADR_MOD_READ_STATUS_WORKING_TEMP_ADR_7 Variable similar to ADR_MOD_STATUS_CURRENT_WORKING_TEMP for THS2-0MM with internal address = 7.			-150	900	R
11305	ADR_MOD_READ_STATUS_WORKING_SET_HEAT_ADR_7 Variable similar to ADR_MOD_STATUS_WORKING_SET_HEAT for THS2-0MM with internal address = 7.			see parameters	see parameters	R
11306	ADR_MOD_READ_STATUS_WORKING_SET_COOL_ADR_7 Variable similar to ADR_MOD_STATUS_WORKING_SET_COOL for THS2-0MM with internal address = 7.			see parameters	see parameters	R
11307	ADR_MOD_READ_STATUS_FAN_SPEED_ADR_7 Variable similar to ADR_MOD_STATUS_CURRENT_FAN_SPEED for THS2-0MM with internal address = 7.			1	3	R
11308	ADR_MOD_READ_STATUS_TOTALHOURS_FAN_ADR_7 Variable similar to ADR_MOD_STATUS_TOTALHOURS_FAN for THS2-0MM with internal address = 7.			0	9999	R
11309	ADR_MOD_READ_STATUS_ALARM_ADR_7 Alarm status for THS2-0MM with address = 7 bit 0 of value = 0 no frost alarm, bit 0 of value = 1 frost alarm bit 1 of value = 0 no alarm on DI1, bit 1 of value = 1 alarm on DI1 (with I07=6) bit 2 of value = 0 no alarm on DI2, bit 2 of value = 1 alarm on DI2 (with I09=6) bit 3 of value = 0 no alarm on AI1 used, bit 3 of value = 1 alarm on AI1 (with I11=9) bit 4 of value = 0 no alarm on AI2 used, bit 4 of value = 1 alarm on AI2 (with I13=9) bit 5 of value = 0 filter not dirty, bit 5 of value = 1 filter dirty.			0	31	R
30310	ADR_MOD_READ_WORK_TEMP_THS2_ADR_7 → Working temperature multiplied by 10 (°C) for THS2-0MM with address = 7 in case I02=1 only. The reading is -200 (corresponding to -20.0°C) in case value not considered or I02≠1			-200	900	R

Address	Description	Par	Def	Min	Max	R/W
11311	ADR_MOD_READ_WORK_HUM_THS2_ADR_7 → Working humidity multiplied by 10 (°C) for THS2-0MM with address = 7 in case internal humidity sensor of THS2 is used. The reading is 0 (corresponding to 0%r.h) in case value not considered.			0	1000	R
11312	ADR_MOD_READ_STATUS_ON_OFF_ADR_7 Variable similar to ADR_MOD_STATUS_CURRENT_ON_OFF for THS2-0MM with internal address = 7.			0	1	R
11313	ADR_MOD_READ_STATUS_CPT_TIMEOUT_COM_ADR_7 → Communication timeout counter between master and THS2-0MM with address = 7	CL7		0	9999	R
11314	ADR_MOD_READ_STATUS_CPT_ERR_DATA_COM_ADR_7 → Data error counter or incorrect addressing between master and slave = 7	Cr7		0	9999	R
11315	ADR_MOD_READ_SPEED_REQUIRED_7 Variable similar to ADR_MOD_FAN_SPEED_MODE for THS2-0MM with internal address = 7			1	4	R
11316	ADR_MOD_READ_SPEED_OFFSET_7 Variable similar to ADR_MOD_OFFSET_SETPOINT for THS2-0MM with internal address = 7			-M12	M12	R
11317	ADR_MOD_READ_SET_USED_7 Variable similar to ADR_MOD_BASICHEATSET or ADR_MOD_BASICCOOLSET in 2-pipe system based on working season or ADR_MOD_BASICSET4PIPE in 4-pipe system, for THS2-0MM with internal address = 7			see variable similar	see variable similar	R
11218	ADR_MOD_READ_PRESENCE_DISPLAY_SUPERV_7 0=external Modbus port not connected 11111=THS2 connected on external Modbus port 11500=THS2 connected on external Modbus port (internal temp, humidity not sent) 22222=supervisor connected on external Modbus port			0	22222	
11319	ADR_MOD_READ_STATUS_AI1_ADR_8 Variable similar to ADR_MOD_STATUS_AI1 for THS2-0MM with internal address = 8			-200	900	R
11320	ADR_MOD_READ_STATUS_AI2_ADR_8 Variable similar to ADR_MOD_STATUS_AI2 for THS2-0MM with internal address = 8			-200	900	R
11321	ADR_MOD_READ_STATUS_WORKING_TEMP_ADR_8 Variable similar to ADR_MOD_STATUS_CURRENT_WORKING_TEMP for THS2-0MM with internal address = 8.			-150	900	R
11322	ADR_MOD_READ_STATUS_WORKING_SET_HEAT_ADR_8 Variable similar to ADR_MOD_STATUS_WORKING_SET_HEAT for THS2-0MM with internal address = 8.			see parameters	see parameters	R
11323	ADR_MOD_READ_STATUS_WORKING_SET_COOL_ADR_8 Variable similar to ADR_MOD_STATUS_WORKING_SET_COOL for THS2-0MM with internal address = 8.			see parameters	see parameters	R
11324	ADR_MOD_READ_STATUS_FAN_SPEED_ADR_8 Variable similar to ADR_MOD_STATUS_CURRENT_FAN_SPEED for THS2-0MM with internal address = 8.			1	3	R
11325	ADR_MOD_READ_STATUS_TOTALHOURSFAN_ADR_8 Variable similar to ADR_MOD_STATUS_TOTALHOURSFAN for THS2-0MM with internal address = 8.			0	9999	R
11326	ADR_MOD_READ_STATUS_ALARM_ADR_8 Alarm status for THS2-0MM with address = 8 bit 0 of value = 0 no frost alarm, bit 0 of value = 1 frost alarm bit 1 of value = 0 no alarm on DI1, bit 1 of value = 1 alarm on DI1 (with I07=6) bit 2 of value = 0 no alarm on DI2, bit 2 of value = 1 alarm on DI2 (with I09=6) bit 3 of value = 0 no alarm on AI1 used, bit 3 of value = 1 alarm on AI1 (with I11=9) bit 4 of value = 0 no alarm on AI2 used, bit 4 of value = 1 alarm on AI2 (with I13=9) bit 5 of value = 0 filter not dirty, bit 5 of value = 1 filter dirty.			0	31	R
11327	ADR_MOD_READ_WORK_TEMP_THS2_ADR_8 → Working temperature multiplied by 10 (°C) for THS2-0MM with address = 8 in case I02=1 only. The reading is -200 (corresponding to -20.0°C) in case value not considered or I02≠1			-200	900	R
11328	ADR_MOD_READ_WORK_HUM_THS2_ADR_8 → Working humidity multiplied by 10 (°C) for THS2-0MM with address = 8 in case internal humidity sensor of THS2 is used. The reading is 0 (corresponding to 0%r.h) in case value not considered.			0	1000	R
11329	ADR_MOD_READ_STATUS_ON_OFF_ADR_8 Variable similar to ADR_MOD_STATUS_CURRENT_ON_OFF for THS2-0MM with internal address = 8.			0	1	R
11330	ADR_MOD_READ_STATUS_CPT_TIMEOUT_COM_ADR_8 → Communication timeout counter between master and THS2-0MM with address = 8	CL8		0	9999	R
11331	ADR_MOD_READ_STATUS_CPT_ERR_DATA_COM_ADR_8 → Data error counter or incorrect addressing between master and slave = 8	Cr8		0	9999	R
11332	ADR_MOD_READ_SPEED_REQUIRED_8 Variable similar to ADR_MOD_FAN_SPEED_MODE for THS2-0MM with internal address = 8			1	4	R

Address	Description	Par	Def	Min	Max	R/W
11333	ADR_MOD_READ_SPEED_OFFSET_8 Variable similar to ADR_MOD_OFFSET_SETPOINT for THS2-0MM with internal address = 8			-112	112	R
11334	ADR_MOD_READ_SET_USED_8 Variable similar to ADR_MOD_BASICHEATSET or ADR_MOD_BASICCOOLSET in 2-pipe system based on working season or ADR_MOD_BASICSET4PIPE in 4-pipe system, for THS2-0MM with internal address = 8			see variable similar	see variable similar	R
11335	ADR_MOD_READ_PRESENCE_DISPLAY_SUPERV_8 0=external Modbus port not connected 11111=THS2 connected on external Modbus port 11500=THS2 connected on external Modbus port (internal temp, humidity not sent) 22222=supervisor connected on external Modbus port			0	22222	
11336	ADR_MOD_READ_STATUS_AI1_ADR_9 Variable similar to ADR_MOD_STATUS_AI1 for THS2-0MM with internal address = 9			-200	900	R
11337	ADR_MOD_READ_STATUS_AI2_ADR_9 Variable similar to ADR_MOD_STATUS_AI2 for THS2-0MM with internal address = 9			-200	900	R
11338	ADR_MOD_READ_STATUS_WORKING_TEMP_ADR_9 Variable similar to ADR_MOD_STATUS_CURRENT_WORKING_TEMP for THS2-0MM with internal address = 9.			-150	900	R
11339	ADR_MOD_READ_STATUS_WORKING_SET_HEAT_ADR_9 Variable similar to ADR_MOD_STATUS_WORKING_SET_HEAT for THS2-0MM with internal address = 9.			see parameters	see parameters	R
11340	ADR_MOD_READ_STATUS_WORKING_SET_COOL_ADR_9 Variable similar to ADR_MOD_STATUS_WORKING_SET_COOL for THS2-0MM with internal address = 9.			see parameters	see parameters	R
11341	ADR_MOD_READ_STATUS_FAN_SPEED_ADR_9 Variable similar to ADR_MOD_STATUS_CURRENT_FAN_SPEED for THS2-0MM with internal address = 9.			1	3	R
11342	ADR_MOD_READ_STATUS_TOTALHOURS_FAN_ADR_9 Variable similar to ADR_MOD_STATUS_TOTALHOURS_FAN for THS2-0MM with internal address = 9.			0	9999	R
11343	ADR_MOD_READ_STATUS_ALARM_ADR_9 Alarm status for THS2-0MM with address = 9 bit 0 of value = 0 no frost alarm, bit 0 of value = 1 frost alarm bit 1 of value = 0 no alarm on DI1, bit 1 of value = 1 alarm on DI1 (with I07=6) bit 2 of value = 0 no alarm on DI2, bit 2 of value = 1 alarm on DI2 (with I09=6) bit 3 of value = 0 no alarm on AI1 used, bit 3 of value = 1 alarm on AI1 (with I11=9) bit 4 of value = 0 no alarm on AI2 used, bit 4 of value = 1 alarm on AI2 (with I13=9) bit 5 of value = 0 filter not dirty, bit 5 of value = 1 filter dirty.			0	31	R
11344	ADR_MOD_READ_WORK_TEMP_THS2_ADR_9 → Working temperature multiplied by 10 (°C) for THS2-0MM with address = 9 in case I02=1 only. The reading is -200 (corresponding to -20.0°C) in case value not considered or I02≠1			-200	900	R
11345	ADR_MOD_READ_WORK_HUM_THS2_ADR_9 → Working humidity multiplied by 10 (°C) for THS2-0MM with address = 9 in case internal humidity sensor of THS2 is used. The reading is 0 (corresponding to 0%r.h) in case value not considered.			0	1000	R
11346	ADR_MOD_READ_STATUS_ON_OFF_ADR_9 Variable similar to ADR_MOD_STATUS_CURRENT_ON_OFF for THS2-0MM with internal address = 9.			0	1	R
11347	ADR_MOD_READ_STATUS_CPT_TIMEOUT_COM_ADR_9 → Communication timeout counter between master and THS2-0MM with address = 9	C09		0	9999	R
11348	ADR_MOD_READ_STATUS_CPT_ERR_DATA_COM_ADR_9 → Data error counter or incorrect addressing between master and slave = 9	C09		0	9999	R
11349	ADR_MOD_READ_SPEED_REQUIRED_9 Variable similar to ADR_MOD_FAN_SPEED_MODE for THS2-0MM with internal address = 9			1	4	R
11350	ADR_MOD_READ_SPEED_OFFSET_9 Variable similar to ADR_MOD_OFFSET_SETPOINT for THS2-0MM with internal address = 9			-112	112	R
11351	ADR_MOD_READ_SET_USED_9 Variable similar to ADR_MOD_BASICHEATSET or ADR_MOD_BASICCOOLSET in 2-pipe system based on working season or ADR_MOD_BASICSET4PIPE in 4-pipe system, for THS2-0MM with internal address = 9			see variable similar	see variable similar	R
11252	ADR_MOD_READ_PRESENCE_DISPLAY_SUPERV_9 0=external Modbus port not connected 11111=THS2 connected on external Modbus port 11500=THS2 connected on external Modbus port (internal temp, humidity not sent) 22222=supervisor connected on external Modbus port			0	22222	
11353	ADR_MOD_READ_STATUS_AI1_ADR_A(10) Variable similar to ADR_MOD_STATUS_AI1 for THS2-0MM with internal address = A(10)			-200	900	R

Address	Description	Par	Def	Min	Max	R/W
11354	ADR_MOD_READ_STATUS_AI2_ADR_A(10) Variable similar to ADR_MOD_STATUS_AI2 for THS2-0MM with internal address = A(10)			-200	900	R
11355	ADR_MOD_READ_STATUS_WORKING_TEMP_ADR_A(10) Variable similar to ADR_MOD_STATUS_CURRENT_WORKING_TEMP for THS2-0MM with internal address = A(10).			-150	900	R
11356	ADR_MOD_READ_STATUS_WORKING_SET_HEAT_ADR_A(10) Variable similar to ADR_MOD_STATUS_WORKING_SET_HEAT for THS2-0MM with internal address = A(10).			see parameters	see parameters	R
11357	ADR_MOD_READ_STATUS_WORKING_SET_COOL_ADR_A(10) Variable similar to ADR_MOD_STATUS_WORKING_SET_COOL for THS2-0MM with internal address = A(10).			see parameters	see parameters	R
11358	ADR_MOD_READ_STATUS_FAN_SPEED_ADR_A(10) Variable similar to ADR_MOD_STATUS_CURRENT_FAN_SPEED for THS2-0MM with internal address = A(10).			1	3	R
11359	ADR_MOD_READ_STATUS_TOTALHOURS_FAN_ADR_A(10) Variable similar to ADR_MOD_STATUS_TOTALHOURS_FAN for THS2-0MM with internal address = A(10).			0	9999	R
11360	ADR_MOD_READ_STATUS_ALARM_ADR_A(10) Alarm status for THS2-0MM with address = 10 bit 0 of value = 0 no frost alarm, bit 0 of value = 1 frost alarm bit 1 of value = 0 no alarm on DI1, bit 1 of value = 1 alarm on DI1 (with I07=6) bit 2 of value = 0 no alarm on DI2, bit 2 of value = 1 alarm on DI2 (with I09=6) bit 3 of value = 0 no alarm on AI1 used, bit 3 of value = 1 alarm on AI1 (with I11=9) bit 4 of value = 0 no alarm on AI2 used, bit 4 of value = 1 alarm on AI2 (with I13=9) bit 5 of value = 0 filter not dirty, bit 5 of value = 1 filter dirty.			0	31	R
11361	ADR_MOD_READ_WORK_TEMP_THS2_ADR_10 → Working temperature multiplied by 10 (°C) for THS2-0MM with address = 10 in case I02=1 only. The reading is -200 (corresponding to -20.0°C) in case value not considered or I02≠1			-200	900	R
11362	ADR_MOD_READ_WORK_HUM_THS2_ADR_10 → Working humidity multiplied by 10 (°C) for THS2-0MM with address = 10 in case internal humidity sensor of THS2 is used. The reading is 0 (corresponding to 0%r.h) in case value not considered.			0	1000	R
11363	ADR_MOD_READ_STATUS_ON_OFF_ADR_A(10) Variable similar to ADR_MOD_STATUS_CURRENT_ON_OFF for THS2-0MM with internal address = A(10).			0	1	R
11364	ADR_MOD_READ_STATUS_CPT_TIMEOUT_COM_ADR_A(10) → Communication timeout counter between master and THS2-0MM with address = A(10)	CLR		0	9999	R
11365	ADR_MOD_READ_STATUS_CPT_ERR_DATA_COM_ADR_A(10) → Data error counter or incorrect addressing between master and slave = A(10)	CLR		0	9999	R
11366	ADR_MOD_READ_SPEED_REQUIRED_A(10) Variable similar to ADR_MOD_FAN_SPEED_MODE for THS2-0MM with internal address = 10			1	4	R
11367	ADR_MOD_READ_SPEED_OFFSET_A(10) Variable similar to ADR_MOD_OFFSET_SETPOINT for THS2-0MM with internal address = 10			-112	112	R
11368	ADR_MOD_READ_SET_USED_A(10) Variable similar to ADR_MOD_BASICHEATSET or ADR_MOD_BASICCOOLSET in 2-pipe system based on working season or ADR_MOD_BASICSET4PIPE in 4-pipe system, for THS2-0MM with internal address = 10			see variable similar	see variable similar	R
11369	ADR_MOD_READ_PRESENCE_DISPLAY_SUPERV_10 0=external Modbus port not connected 1111=THS2 connected on external Modbus port 1150=THS2 connected on external Modbus port (internal temp, humidity not sent) 2222=supervisor connected on external Modbus port			0	2222	
11370	ADR_MOD_READ_STATUS_AI1_ADR_B(11) Variable similar to ADR_MOD_STATUS_AI1 for THS2-0MM with internal address = B(11)			-200	900	R
11371	ADR_MOD_READ_STATUS_AI2_ADR_B(11) Variable similar to ADR_MOD_STATUS_AI2 for THS2-0MM with internal address = B(11)			-200	900	R
11372	ADR_MOD_READ_STATUS_WORKING_TEMP_ADR_B(11) Variable similar to ADR_MOD_STATUS_CURRENT_WORKING_TEMP for THS2-0MM with internal address = B(11).			-150	900	R
11373	ADR_MOD_READ_STATUS_WORKING_SET_HEAT_ADR_B(11) Variable similar to ADR_MOD_STATUS_WORKING_SET_HEAT for THS2-0MM with internal address = B(11).			see parameters	see parameters	R
11374	ADR_MOD_READ_STATUS_WORKING_SET_COOL_ADR_B(11) Variable similar to ADR_MOD_STATUS_WORKING_SET_COOL for THS2-0MM with internal address = B(11).			see parameters	see parameters	R

Address	Description	Par	Def	Min	Max	R/W
11375	ADR_MOD_READ_STATUS_FAN_SPEED_ADR_B(11) Variable similar to ADR_MOD_STATUS_CURRENT_FAN_SPEED for THS2-0MM with internal address = B(11).			1	3	R
11376	ADR_MOD_READ_STATUS_TOTALHOURSFAN_ADR_B(11) Variable similar to ADR_MOD_STATUS_TOTALHOURSFAN for THS2-0MM with internal address = B(11).			0	9999	R
11377	ADR_MOD_READ_STATUS_ALARM_ADR_B(11) Alarm status for THS2-0MM with address = 11 bit 0 of value = 0 no frost alarm, bit 0 of value = 1 frost alarm bit 1 of value = 0 no alarm on DI1, bit 1 of value = 1 alarm on DI1 (with I07=6) bit 2 of value = 0 no alarm on DI2, bit 2 of value = 1 alarm on DI2 (with I09=6) bit 3 of value = 0 no alarm on AI1 used, bit 3 of value = 1 alarm on AI1 (with I11=9) bit 4 of value = 0 no alarm on AI2 used, bit 4 of value = 1 alarm on AI2 (with I13=9) bit 5 of value = 0 filter not dirty, bit 5 of value = 1 filter dirty.			0	31	R
11378	ADR_MOD_READ_WORK_TEMP_THS2_ADR_11 → Working temperature multiplied by 10 (°C) for THS2-0MM with address = 11 in case I02=1 only. The reading is -200 (corresponding to -20.0°C) in case value not considered or I02≠1			-200	900	R
11379	ADR_MOD_READ_WORK_HUM_THS2_ADR_11 → Working humidity multiplied by 10 (°C) for THS2-0MM with address = 11 in case internal humidity sensor of THS2 is used. The reading is 0 (corresponding to 0%r.h) in case value not considered.			0	1000	R
11380	ADR_MOD_READ_STATUS_ON_OFF_ADR_B(11) Variable similar to ADR_MOD_STATUS_CURRENT_ON_OFF for THS2-0MM with internal address = B(11).			0	1	R
11381	ADR_MOD_READ_STATUS_CPT_TIMEOUT_COM_ADR_B(11) → Communication timeout counter between master and THS2-0MM with address = B(11)	Lb		0	9999	R
11382	ADR_MOD_READ_STATUS_CPT_ERR_DATA_COM_ADR_B(11) → Data error counter or incorrect addressing between master and slave = B(11)	rb		0	9999	R
11383	ADR_MOD_READ_SPEED_REQUIRED_B(11) Variable similar to ADR_MOD_FAN_SPEED_MODE for THS2-0MM with internal address = 11			1	4	R
11384	ADR_MOD_READ_SPEED_OFFSET_B(11) Variable similar to ADR_MOD_OFFSET_SETPOINT for THS2-0MM with internal address = 11			-M12	M12	R
11385	ADR_MOD_READ_SET_USED_B(11) Variable similar to ADR_MOD_BASICHEATSET or ADR_MOD_BASICCOOLSET in 2-pipe system based on working season or ADR_MOD_BASICSET4PIPE in 4-pipe system, for THS2-0MM with internal address = 11			see variable similar	see variable similar	R
11386	ADR_MOD_READ_PRESENCE_DISPLAY_SUPERV_11 0=external Modbus port not connected 11111=THS2 connected on external Modbus port 11500=THS2 connected on external Modbus port (internal temp, humidity not sent) 22222=supervisor connected on external Modbus port			0	22222	
11387	ADR_MOD_READ_STATUS_AI1_ADR_C(12) Variable similar to ADR_MOD_STATUS_AI1 for THS2-0MM with internal address = C(12)			-200	900	R
11388	ADR_MOD_READ_STATUS_AI2_ADR_C(12) Variable similar to ADR_MOD_STATUS_AI2 for THS2-0MM with internal address = C(12)			-200	900	R
11389	ADR_MOD_READ_STATUS_WORKING_TEMP_ADR_C(12) Variable similar to ADR_MOD_STATUS_CURRENT_WORKING_TEMP for THS2-0MM with internal address = C(12).			-150	900	R
11390	ADR_MOD_READ_STATUS_WORKING_SET_HEAT_ADR_C(12) Variable similar to ADR_MOD_STATUS_WORKING_SET_HEAT for THS2-0MM with internal address = C(12).			see parameters	see parameters	R
11391	ADR_MOD_READ_STATUS_WORKING_SET_COOL_ADR_C(12) Variable similar to ADR_MOD_STATUS_WORKING_SET_COOL for THS2-0MM with internal address = C(12).			see parameters	see parameters	R
11392	ADR_MOD_READ_STATUS_FAN_SPEED_ADR_C(12) Variable similar to ADR_MOD_STATUS_CURRENT_FAN_SPEED for THS2-0MM with internal address = C(12).			1	3	R
11393	ADR_MOD_READ_STATUS_TOTALHOURSFAN_ADR_C(12) Variable similar to ADR_MOD_STATUS_TOTALHOURSFAN for THS2-0MM with internal address = C(12).			0	9999	R
11394	ADR_MOD_READ_STATUS_ALARM_ADR_C(12) Alarm status for THS2-0MM with address = 12 bit 0 of value = 0 no frost alarm, bit 0 of value = 1 frost alarm bit 1 of value = 0 no alarm on DI1, bit 1 of value = 1 alarm on DI1 (with I07=6) bit 2 of value = 0 no alarm on DI2, bit 2 of value = 1 alarm on DI2 (with I09=6) bit 3 of value = 0 no alarm on AI1 used, bit 3 of value = 1 alarm on AI1 (with I11=9) bit 4 of value = 0 no alarm on AI2 used, bit 4 of value = 1 alarm on AI2 (with I13=9) bit 5 of value = 0 filter not dirty, bit 5 of value = 1 filter dirty.			0	31	R

Address	Description	Par	Def	Min	Max	R/W
11395	ADR_MOD_READ_WORK_TEMP_THS2_ADR_12 → Working temperature multiplied by 10 (°C) for THS2-0MM with address = 12 in case $I\theta 2=1$ only. The reading is -200 (corresponding to -20.0°C) in case value not considered or $I\theta 2\neq 1$			-200	900	R
11396	ADR_MOD_READ_WORK_HUM_THS2_ADR_12 → Working humidity multiplied by 10 (°C) for THS2-0MM with address = 12 in case internal humidity sensor of THS2 is used. The reading is 0 (corresponding to 0%r.h) in case value not considered.			0	1000	R
11397	ADR_MOD_READ_STATUS_ON_OFF_ADR_C(12) Variable similar to ADR_MOD_STATUS_CURRENT_ON_OFF for THS2-0MM with internal address = C(12).			0	1	R
11398	ADR_MOD_READ_STATUS_CPT_TIMEOUT_COM_ADR_C(12) → Communication timeout counter between master and THS2-0MM with address = C(12)	$C\&L\&C$		0	9999	R
11399	ADR_MOD_READ_STATUS_CPT_ERR_DATA_COM_ADR_C(12) → Data error counter or incorrect addressing between master and slave = C(12)	$C\&r\&C$		0	9999	R
11400	ADR_MOD_READ_SPEED_REQUIRED_C(12) Variable similar to ADR_MOD_FAN_SPEED_MODE for THS2-0MM with internal address = 12			1	4	R
11401	ADR_MOD_READ_SPEED_OFFSET_C(12) Variable similar to ADR_MOD_OFFSET_SETPOINT for THS2-0MM with internal address = 12			$-M\ 12$	$M\ 12$	R
11402	ADR_MOD_READ_SET_USED_C(12) Variable similar to ADR_MOD_BASICHEATSET or ADR_MOD_BASICCOOLSET in 2-pipe system based on working season or ADR_MOD_BASICSET4PIPE in 4-pipe system, for THS2-0MM with internal address = 12			see variable similar	see variable similar	R
11403	ADR_MOD_READ_PRESENCE_DISPLAY_SUPERV_12 0=external Modbus port not connected 1111=THS2 connected on external Modbus port 11500=THS2 connected on external Modbus port (internal temp, humidity not sent) 22222=supervisor connected on external Modbus port			0	22222	
11404	ADR_MOD_READ_STATUS_AI1_ADR_D(13) Variable similar to ADR_MOD_STATUS_AI1 for THS2-0MM with internal address = D(13)			-200	900	R
11405	ADR_MOD_READ_STATUS_AI2_ADR_D(13) Variable similar to ADR_MOD_STATUS_AI2 for THS2-0MM with internal address = D(13)			-200	900	R
11406	ADR_MOD_READ_STATUS_WORKING_TEMP_ADR_D(13) Variable similar to ADR_MOD_STATUS_CURRENT_WORKING_TEMP for THS2-0MM with internal address = D(13).			-150	900	R
11407	ADR_MOD_READ_STATUS_WORKING_SET_HEAT_ADR_D(13) Variable similar to ADR_MOD_STATUS_WORKING_SET_HEAT for THS2-0MM with internal address = D(13).			see parameters	see parameters	R
11408	ADR_MOD_READ_STATUS_WORKING_SET_COOL_ADR_D(13) Variable similar to ADR_MOD_STATUS_WORKING_SET_COOL for THS2-0MM with internal address = D(13).			see parameters	see parameters	R
11409	ADR_MOD_READ_STATUS_FAN_SPEED_ADR_D(13) Variable similar to ADR_MOD_STATUS_CURRENT_FAN_SPEED for THS2-0MM with internal address = D(13).			1	3	R
11410	ADR_MOD_READ_STATUS_TOTALHOURS_FAN_ADR_D(13) Variable similar to ADR_MOD_STATUS_TOTALHOURS_FAN for THS2-0MM with internal address = D(13).			0	9999	R
11411	ADR_MOD_READ_STATUS_ALARM_ADR_D(13) Alarm status for THS2-0MM with address = 13 bit 0 of value = 0 no frost alarm, bit 0 of value = 1 frost alarm bit 1 of value = 0 no alarm on DI1, bit 1 of value = 1 alarm on DI1 (with $I\theta 7=6$) bit 2 of value = 0 no alarm on DI2, bit 2 of value = 1 alarm on DI2 (with $I\theta 9=6$) bit 3 of value = 0 no alarm on AI1 used, bit 3 of value = 1 alarm on AI1 (with $I\ 11=9$) bit 4 of value = 0 no alarm on AI2 used, bit 4 of value = 1 alarm on AI2 (with $I\ 13=9$) bit 5 of value = 0 filter not dirty, bit 5 of value = 1 filter dirty.			0	31	R
11412	ADR_MOD_READ_WORK_TEMP_THS2_ADR_13 → Working temperature multiplied by 10 (°C) for THS2-0MM with address = 13 in case $I\theta 2=1$ only. The reading is -200 (corresponding to -20.0°C) in case value not considered or $I\theta 2\neq 1$			-200	900	R
11413	ADR_MOD_READ_WORK_HUM_THS2_ADR_13 → Working humidity multiplied by 10 (°C) for THS2-0MM with address = 13 in case internal humidity sensor of THS2 is used. The reading is 0 (corresponding to 0%r.h) in case value not considered.			0	1000	R
11414	ADR_MOD_READ_STATUS_ON_OFF_ADR_D(13) Variable similar to ADR_MOD_STATUS_CURRENT_ON_OFF for THS2-0MM with internal address = D(13).			0	1	R
11415	ADR_MOD_READ_STATUS_CPT_TIMEOUT_COM_ADR_D(13) → Communication timeout counter between master and THS2-0MM with address = D(13)	$C\&L\&d$		0	9999	R
11416	ADR_MOD_READ_STATUS_CPT_ERR_DATA_COM_ADR_D(13) → Data error counter or incorrect addressing between master and slave = D(13)	$C\&r\&d$		0	9999	R

Address	Description	Par	Def	Min	Max	R/W
11417	ADR_MOD_READ_SPEED_REQUIRED_D(13) Variable similar to ADR_MOD_FAN_SPEED_MODE for THS2-0MM with internal address = 13			1	4	R
11418	ADR_MOD_READ_SPEED_OFFSET_D(13) Variable similar to ADR_MOD_OFFSET_SETPOINT for THS2-0MM with internal address = 13			-M 12	M 12	R
11419	ADR_MOD_READ_SET_USED_D(13) Variable similar to ADR_MOD_BASICHEATSET or ADR_MOD_BASICCOOLSET in 2-pipe system based on working season or ADR_MOD_BASICSET4PIPE in 4-pipe system, for THS2-0MM with internal address = 13			see variable similar	see variable similar	R
11420	ADR_MOD_READ_PRESENCE_DISPLAY_SUPERV_13 0=external Modbus port not connected 1111=THS2 connected on external Modbus port 1150=THS2 connected on external Modbus port (internal temp, humidity not sent) 2222=supervisor connected on external Modbus port			0	22222	
11421	ADR_MOD_READ_STATUS_AI1_ADR_E(14) Variable similar to ADR_MOD_STATUS_AI1 for THS2-0MM with internal address = E(14)			-200	900	R
11422	ADR_MOD_READ_STATUS_AI2_ADR_E(14) Variable similar to ADR_MOD_STATUS_AI2 for THS2-0MM with internal address = E(14)			-200	900	R
11423	ADR_MOD_READ_STATUS_WORKING_TEMP_ADR_E(14) Variable similar to ADR_MOD_STATUS_CURRENT_WORKING_TEMP for THS2-0MM with internal address = E(14).			-150	900	R
11424	ADR_MOD_READ_STATUS_WORKING_SET_HEAT_ADR_E(14) Variable similar to ADR_MOD_STATUS_WORKING_SET_HEAT for THS2-0MM with internal address = E(14).			see parameters	see parameters	R
11425	ADR_MOD_READ_STATUS_WORKING_SET_COOL_ADR_E(14) Variable similar to ADR_MOD_STATUS_WORKING_SET_COOL for THS2-0MM with internal address = E(14).			see parameters	see parameters	R
11426	ADR_MOD_READ_STATUS_FAN_SPEED_ADR_E(14) Variable similar to ADR_MOD_STATUS_CURRENT_FAN_SPEED for THS2-0MM with internal address = E(14).			1	3	R
11427	ADR_MOD_READ_STATUS_TOTALHOURS_FAN_ADR_E(14) Variable similar to ADR_MOD_STATUS_TOTALHOURS_FAN for THS2-0MM with internal address = E(14).			0	9999	R
11428	ADR_MOD_READ_STATUS_ALARM_ADR_E(14) Alarm status for THS2-0MM with address = 14 bit 0 of value = 0 no frost alarm, bit 0 of value = 1 frost alarm bit 1 of value = 0 no alarm on DI1, bit 1 of value = 1 alarm on DI1 (with I07=6) bit 2 of value = 0 no alarm on DI2, bit 2 of value = 1 alarm on DI2 (with I09=6) bit 3 of value = 0 no alarm on AI1 used, bit 3 of value = 1 alarm on AI1 (with I11=9) bit 4 of value = 0 no alarm on AI2 used, bit 4 of value = 1 alarm on AI2 (with I13=9) bit 5 of value = 0 filter not dirty, bit 5 of value = 1 filter dirty.			0	31	R
11429	ADR_MOD_READ_WORK_TEMP_THS2_ADR_14 → Working temperature multiplied by 10 (°C) for THS2-0MM with address = 14 in case I02=1 only. The reading is -200 (corresponding to -20.0°C) in case value not considered or I02≠1			-200	900	R
11430	ADR_MOD_READ_WORK_HUM_THS2_ADR_14 → Working humidity multiplied by 10 (°C) for THS2-0MM with address = 14 in case internal humidity sensor of THS2 is used. The reading is 0 (corresponding to 0%r.h) in case value not considered.			0	1000	R
11431	ADR_MOD_READ_STATUS_ON_OFF_ADR_E(14) Variable similar to ADR_MOD_STATUS_CURRENT_ON_OFF for THS2-0MM with internal address = E(14).			0	1	R
11432	ADR_MOD_READ_STATUS_CPT_TIMEOUT_COM_ADR_E(14) → Communication timeout counter between master and THS2-0MM with address = E(14)	CLE		0	9999	R
11433	ADR_MOD_READ_STATUS_CPT_ERR_DATA_COM_ADR_E(14) → Data error counter or incorrect addressing between master and slave = E(14)	CrE		0	9999	R
11434	ADR_MOD_READ_SPEED_REQUIRED_E(14) Variable similar to ADR_MOD_FAN_SPEED_MODE for THS2-0MM with internal address = 14			1	4	R
11435	ADR_MOD_READ_SPEED_OFFSET_E(14) Variable similar to ADR_MOD_OFFSET_SETPOINT for THS2-0MM with internal address = 14			-M 12	M 12	R
11436	ADR_MOD_READ_SET_USED_E(14) Variable similar to ADR_MOD_BASICHEATSET or ADR_MOD_BASICCOOLSET in 2-pipe system based on working season or ADR_MOD_BASICSET4PIPE in 4-pipe system, for THS2-0MM with internal address = 14			see variable similar	see variable similar	R

Address	Description	Par	Def	Min	Max	R/W
11437	ADR_MOD_READ_PRESENCE_DISPLAY_SUPERV_14 0=external Modbus port not connected 11111=THS2 connected on external Modbus port 11500=THS2 connected on external Modbus port (internal temp, humidity not sent) 22222=supervisor connected on external Modbus port			0	22222	
11438	ADR_MOD_READ_STATUS_AI1_ADR_F(15) Variable similar to ADR_MOD_STATUS_AI1 for THS2-0MM with internal address = F(15)			-200	900	R
11439	ADR_MOD_READ_STATUS_AI2_ADR_F(15) Variable similar to ADR_MOD_STATUS_AI2 for THS2-0MM with internal address = F(15)			-200	900	R
11440	ADR_MOD_READ_STATUS_WORKING_TEMP_ADR_F(15) Variable similar to ADR_MOD_STATUS_CURRENT_WORKING_TEMP for THS2-0MM with internal address = F(15).			-150	900	R
11441	ADR_MOD_READ_STATUS_WORKING_SET_HEAT_ADR_F(15) Variable similar to ADR_MOD_STATUS_WORKING_SET_HEAT for THS2-0MM with internal address = F(15).			see parameters	see parameters	R
11442	ADR_MOD_READ_STATUS_WORKING_SET_COOL_ADR_F(15) Variable similar to ADR_MOD_STATUS_WORKING_SET_COOL for THS2-0MM with internal address = F(15).			see parameters	see parameters	R
11443	ADR_MOD_READ_STATUS_FAN_SPEED_ADR_F(15) Variable similar to ADR_MOD_STATUS_CURRENT_FAN_SPEED for THS2-0MM with internal address = F(15).			1	3	R
11444	ADR_MOD_READ_STATUS_TOTALHOURS_FAN_ADR_F(15) Variable similar to ADR_MOD_STATUS_TOTALHOURS_FAN for THS2-0MM with internal address = F(15).			0	9999	R
11445	ADR_MOD_READ_STATUS_ALARM_ADR_F(15) Alarm status for THS2-0MM with address = 15 bit 0 of value = 0 no frost alarm, bit 0 of value = 1 frost alarm bit 1 of value = 0 no alarm on DI1, bit 1 of value = 1 alarm on DI1 (with I07=6) bit 2 of value = 0 no alarm on DI2, bit 2 of value = 1 alarm on DI2 (with I09=6) bit 3 of value = 0 no alarm on AI1 used, bit 3 of value = 1 alarm on AI1 (with I11=9) bit 4 of value = 0 no alarm on AI2 used, bit 4 of value = 1 alarm on AI2 (with I13=9) bit 5 of value = 0 filter not dirty, bit 5 of value = 1 filter dirty.			0	31	R
11446	ADR_MOD_READ_WORK_TEMP_THS2_ADR_15 → Working temperature multiplied by 10 (°C) for THS2-0MM with address = 15 in case I02=1 only. The reading is -200 (corresponding to -20.0°C) in case value not considered or I02≠1			-200	900	R
11447	ADR_MOD_READ_WORK_HUM_THS2_ADR_15 → Working humidity multiplied by 10 (°C) for THS2-0MM with address = 15 in case internal humidity sensor of THS2 is used. The reading is 0 (corresponding to 0%r.h) in case value not considered.			0	1000	R
11448	ADR_MOD_READ_STATUS_ON_OFF_ADR_F(15) Variable similar to ADR_MOD_STATUS_CURRENT_ON_OFF for THS2-0MM with internal address = F(15).			0	1	R
11449	ADR_MOD_READ_STATUS_CPT_TIMEOUT_COM_ADR_F(15) → Communication timeout counter between master and THS2-0MM with address = F(15)	CLF		0	9999	R
11450	ADR_MOD_READ_STATUS_CPT_ERR_DATA_COM_ADR_F(15) → Data error counter or incorrect addressing between master and slave = F(15)	CrF		0	9999	R
11451	ADR_MOD_READ_SPEED_REQUIRED_F(15) Variable similar to ADR_MOD_FAN_SPEED_MODE for THS2-0MM with internal address = 15			1	4	R
11452	ADR_MOD_READ_SPEED_OFFSET_F(15) Variable similar to ADR_MOD_OFFSET_SETPOINT for THS2-0MM with internal address = 15			-M12	M12	R
11453	ADR_MOD_READ_SET_USED_F(15) Variable similar to ADR_MOD_BASICHEATSET or ADR_MOD_BASICCOOLSET in 2-pipe system based on working season or ADR_MOD_BASICSET4PIPE in 4-pipe system, for THS2-0MM with internal address = 15			see variable similar	see variable similar	R
11454	ADR_MOD_READ_PRESENCE_DISPLAY_SUPERV_15 0=external Modbus port not connected 11111=THS2 connected on external Modbus port 11500=THS2 connected on external Modbus port (internal temp, humidity not sent) 22222=supervisor connected on external Modbus port			0	22222	
11455	ADR_MOD_READ_STATUS_TRASM_HUM → Variable similar to ADR_MOD_STATUS_CURRENT_TRASM_HUM			0	1000	R
11456	ADR_MOD_READ_STATUS_TRASM_CO2 → Variable similar to ADR_MOD_STATUS_CURRENT_TRASM_CO2			0	2000	R
11457	ADR_MOD_READ_STATUS_CPT_TIMEOUT_COM_ADR_20 → Communication timeout counter between master and transmitter with address = 20	CLL		0	9999	R
11458	ADR_MOD_READ_STATUS_CPT_ERR_DATA_COM_ADR_20 → Data error counter or incorrect addressing between master and transmitter with address = 20	CrL		0	9999	R

53. Electrical connections

 Installation and maintenance operations must be carried out by qualified personnel with no power supply to the appliance and with no external loads. AB Industrietechnik shall not be liable for any damage caused by improper installation and/or tampering with or removal of safety devices.

• THS2-0MM unit connection

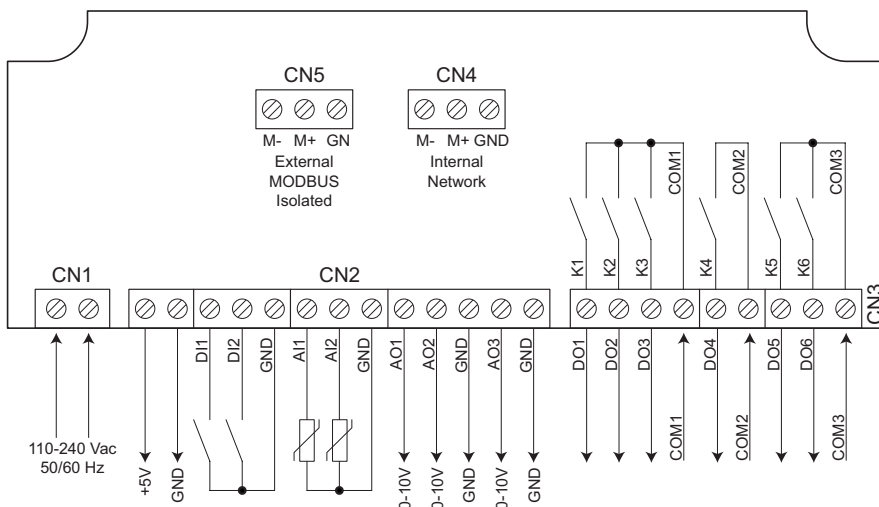
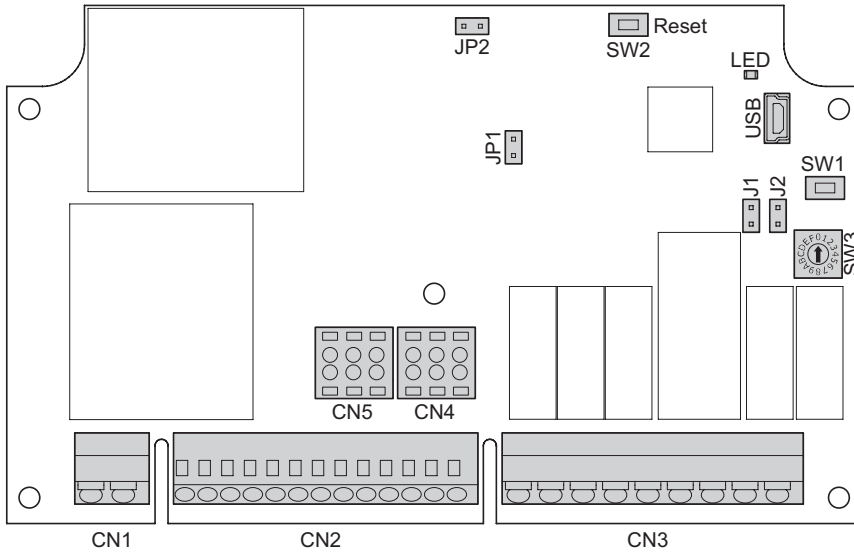

Terminal blocks:

Connector CN1:

power supply 110-240 Vac

Connector CN2:

+5V GND = power supply output for THS2 unit

DI1 - DI2 = digital inputs 1 and 2

AI1 - AI2 = analogue inputs 1 and 2

AO1 - AO2 - AO3 = analogue outputs 1-3

Connector CN3:

DO1 - DO2 - DO3 - DO4 - DO5 - DO6 = digital outputs 1-6

COM1 = common for digital outputs 1-3

COM2 = common for digital output 4

COM3 = common for digital outputs 5-6

Connector CN4:

M- / M + GND = internal communication network (twin connector)

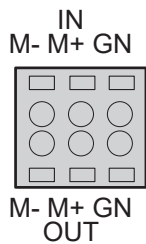

Connector CN5:

M- / M + GN = external Modbus network (twin connector)

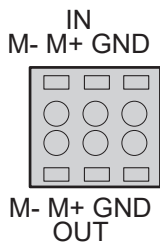

GND = common for digital inputs, analogue inputs, analogue outputs and internal communication network

GN = common for external Modbus network (to supervisor)

Note: The external Modbus network is isolated from the internal network. Consequently, GND and GN terminals are not connected to each other. **if a THS2 is connected to THS2-0MM connect together GND and GN.**

SW1 = key not used

SW2 = reset button

SW3 = rotary switch for selecting THS2-0MM unit address in the internal network (the chosen address must be between 1 and 15(F)). **Each unit in the internal network must have an address different and all addresses must be continuous from 1 to X with X corresponding to parameter *M20*.**

The address on the rotary switch is not only valid for internal network but also for external network when J2 is off (with SW3≠0).

LED =

- flashes during normal operation (1 flash/s) if the position of rotary switch SW3 is between 1 and 15.
- steady on (THS2-0MM address error value 0 selected)

USB = USB connection port for software update

JP1 = Term. ON → 120 ohm internal network line termination resistance INSERTED.

JP1 = OFF → 120 ohm internal network line termination resistance NOT INSERTED.

JP2 = Term. ON → 120 ohm external (to supervisor or THS2 unit) Modbus line termination resistance INSERTED.

JP2 = OFF → 120 ohm resistance for external Modbus line termination (to supervisor or THS2 unit) NOT INSERTED.

[SW3≠0: network on CN4 with THS2-0MM master + THS2-0MM slaves, supervisor or THS2 on CN5 of THS2-0MM master, others THS2 connected to slaves on CN5]:

J1 = ON -> THS2-0MM is the master for internal network. He transmits all parameters setting to slaves.

J1 = OFF -> THS2-0MM is a slave for internal network

J2 = ON -> the address of THS2-0MM master in the external network is variable **ADR_MOD_MODBUS_ADDRESS_NETWORK**

(11149) parameter *M 19*

J2 = OFF -> the address of THS2-0MM master in the external network is the address set on rotary switch SW3.

[SW3=0: network on CN4 with THS2-0MM slaves, supervisor on CN4, others THS2 connected to THS2-0MM slaves on CN5]:

J1 = OFF -> THS2-0MM is a slave for internal network.

J2 = ON -> the address of THS2-0MM slave in the internal network is variable ADR_MOD_MODBUS_ADDRESS_NETWORK (11149) (parameter *M 19*)

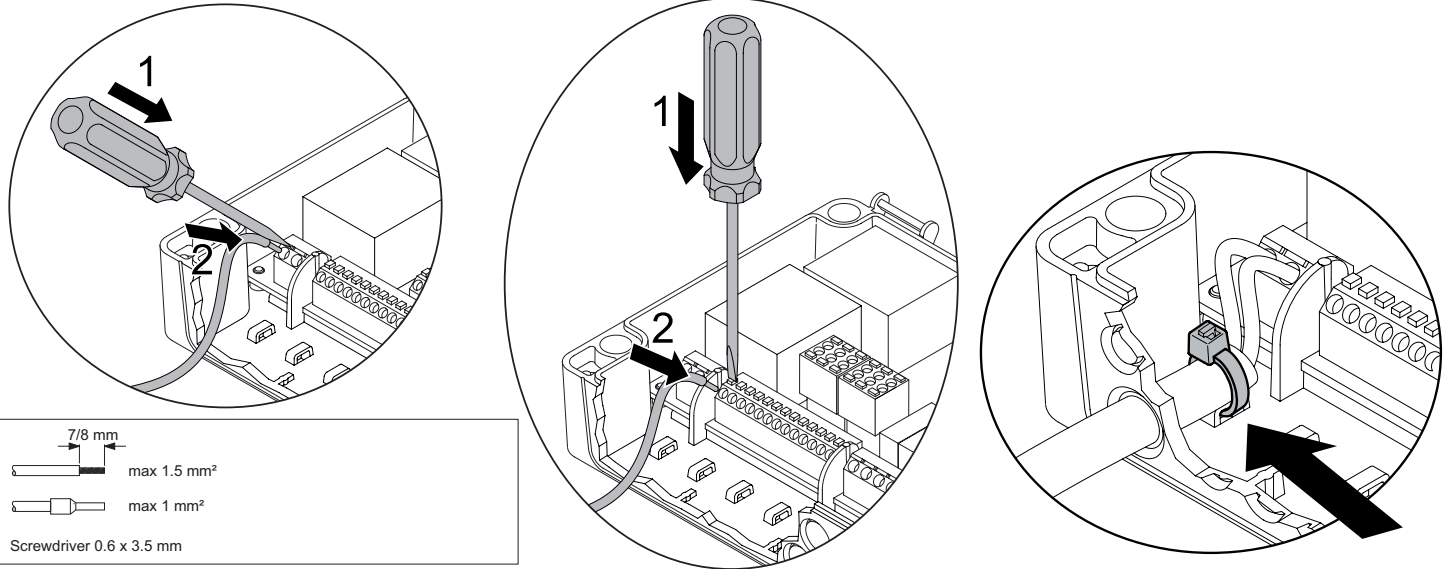

**Note: use different cable ties to maintain cables together near connectors.
Twin connectors for CN4 and CN5 make connections easy for Modbus line.**

• THS2 unit connection

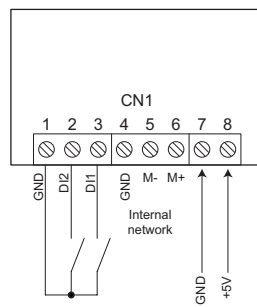
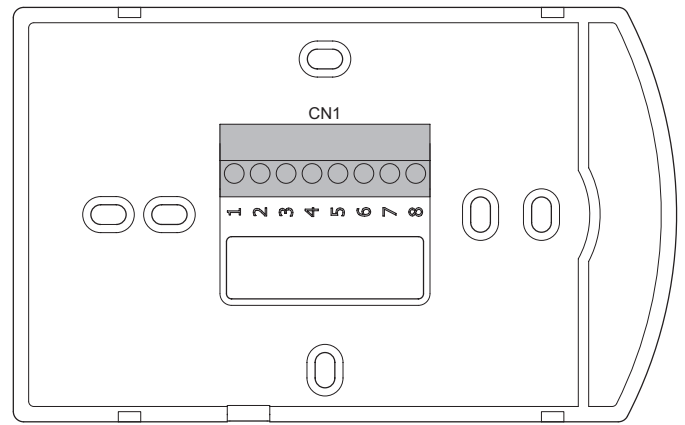
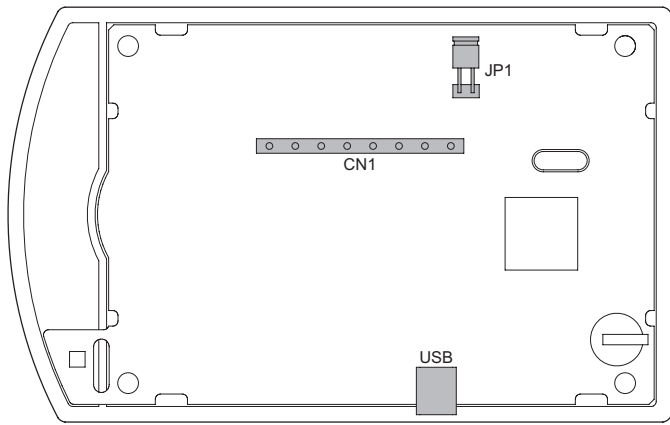

Terminal blocks:

5V - GND=5 Vdc power supply supplied by THS2-0MM unit.

DI1 - DI2 =digital inputs 1 and 2

M + / M -=internal network

GND =common for digital inputs and internal network.

JP1=Term. ON → 120 ohm internal network line termination resistance INSERTED.

JP1=OFF → 120 ohm internal network line termination resistance NOT INSERTED.

USB= Mini B USB connection for software update and THS2 parameters setting.

54. Networks connection diagram

• Internal network connection diagram without supervisor on CN4

The internal network consists of:

- a master unit which allows the operating parameters of each slave and the master itself to be set
- 1 to 14 slave units: the parameter $M20$ is the sum of the number of slaves and master unit (on the example below $M20=15$)
- an optional humidity and CO₂ transmitter whose presence is defined by parameter $M21$.

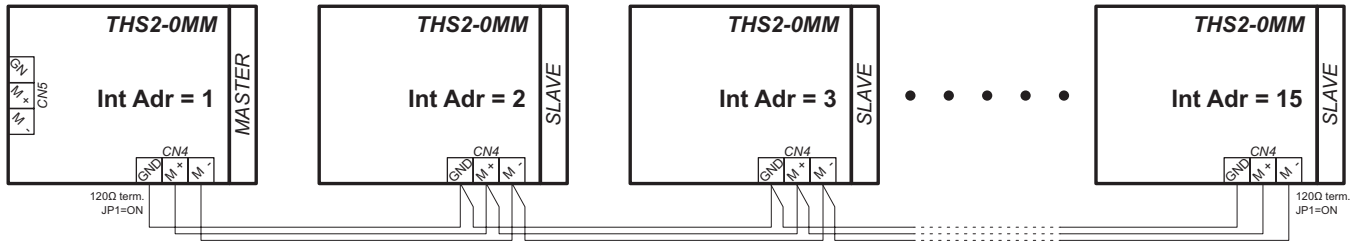

If there is a humidity or CO₂ transmitter present, set the following communication parameters:

Address=20, baud rate=9600 bit/s, even parity.

The minimum configuration of the internal network consists of 1 master unit ($M20=1$) with address 1.

The maximum configuration of the internal network consists of 1 master unit connected to 14 slave units ($M20=15$) with addresses 1, 2, 3, 4, 5, 6, 7, 8, 9, A(10), B(11), C(12), D(13), E(14), F(15) respectively.

Addresses must be set for each THS2-0MM (master or slave) by means of an SW3 rotary switch located on each THS2-0MM card:



Address 0 is not valid (see "5. THS2-0MM connected to THS2 and supervisor contemporaneously" page 12). Address A=10, B=11, C=12, D=13, E=14, F=15.

Do not set the rotary switch to a value of between outside the value of parameter $M20$. Even the master of internal network needs to have an address defined. All units that make up the internal network must have addresses continuous from 1 to the value of parameter $M19$.

• Internal network connection diagram with supervisor on CN4

The internal network consists of:

- a supervisor which allows the operating parameters of each slave to be set
- 1 to xx (xx=247, address 20 excluded) slave units connected or not to THS2 units

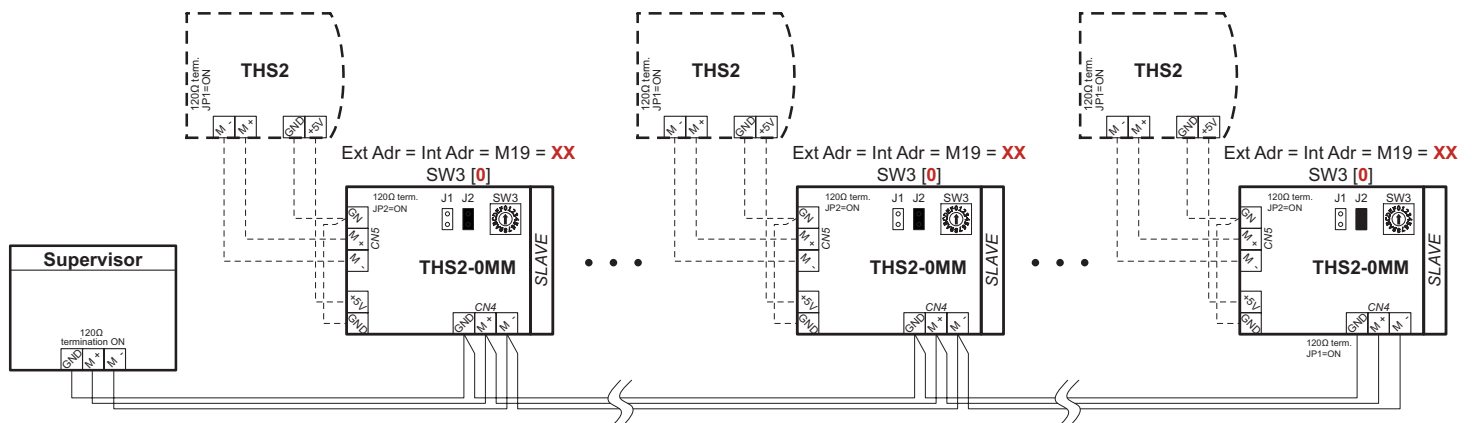

The maximum configuration of the internal network consists of 246 slave units.

Addresses must be set for each THS2-0MM slave by means of parameter $M19$ with SW3=0 (rotary switch located on each THS2-0MM card).



Address 0 is valid (see [“5. THS2-0MM connected to THS2 and supervisor contemporaneously” page 12](#)).

Do not set the rotary switch to a value different than 0 otherwise internal baud rate and parity are set to fixed 9600 bit/s with even parity.

If the settings are correct for J1, J2, SW3, the LED flashes; otherwise it remains steadily on (error).

After selecting the device address in the internal network, it is not necessary to perform a reset by pressing the SW2 key (reset) or switch the device off and on again to consider the new address because change of address can be done dynamically.

If there are continuous communication problems between master and slaves, any forcing of inputs/outputs, exchange of temperature, are no longer considered after approximately 10 minutes. Using password 66, it is possible to access the communication status variables of each slave and monitor any communication errors between the master and any slave (parameters E_{L-x} , E_{r-x} with x =number of slave concerned).

Use cables with a twisted pair + 1 wire for ground + shield.

Use the twisted pair to connect **M+** and **M-** and the single wire for the **GND** which must be connected to each device.

Connect the shield to ground at a single point on the cable as close to the master as possible.

The type of cable must comply with the properties required for data transmission over MODBUS RS485 protocol (e.g. Belden 3106A cable).

The two bus ends must be connected with a 120 ohm termination resistance.

To insert the 120 ohm resistance on the controller, see [“50. Jumper configuration” page 86](#).

The maximum bus length depends on baud rate and on the cable length.

For a baud rate of 9600, the maximum cable length can reach 1000 m with an AVG26 cable.

Any derivations that are used must be short and must not exceed 20 m. With a multi-port tap used for n derivations, each derivation must have a maximum length of 40 m divided by n .

• External MODBUS network connection diagram with supervisor on CN5

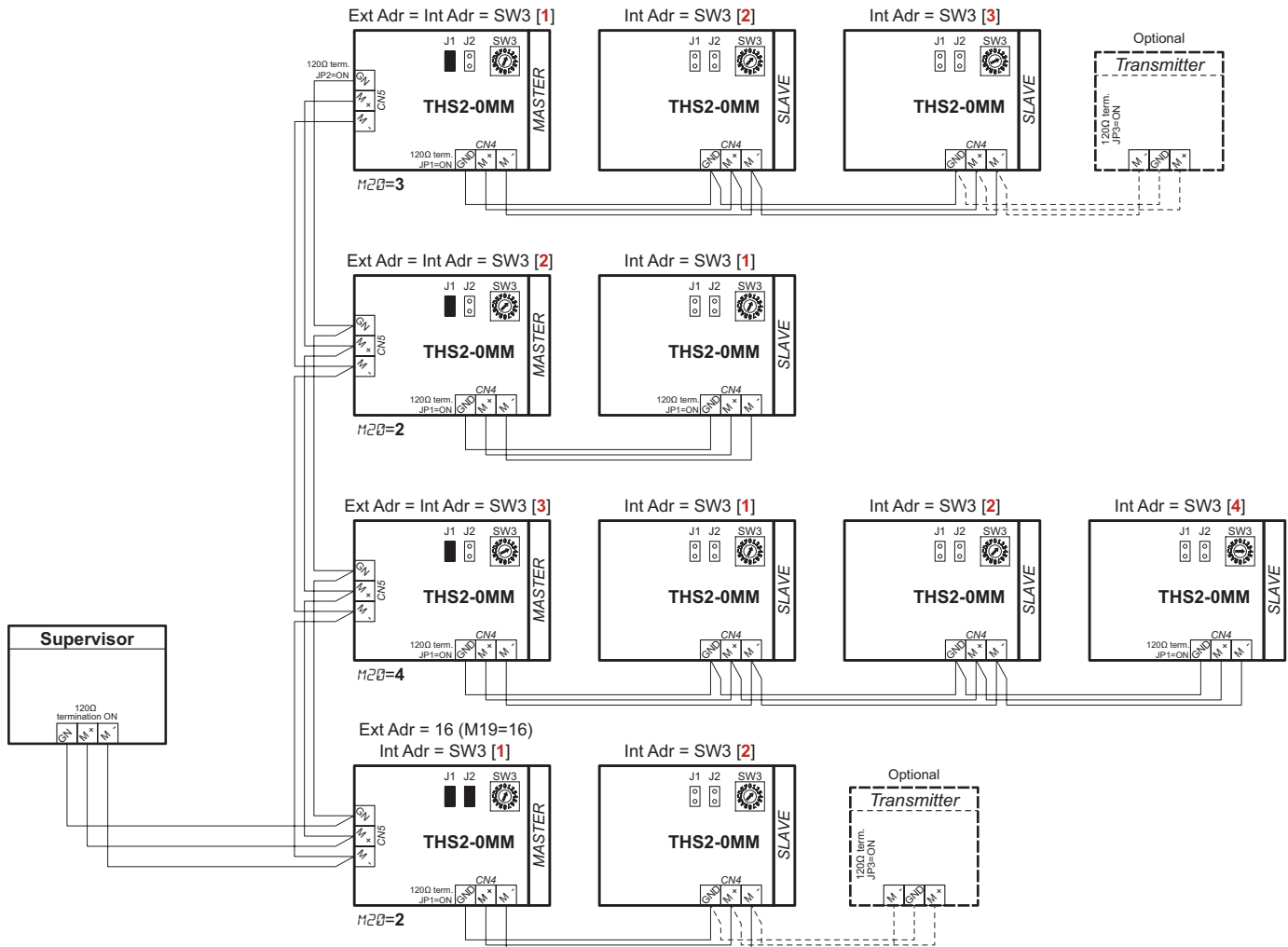

The external Modbus network allows the connection of a supervisor on the second port CN5 of THS2-0MM master units. It is possible to connect several internal networks to the same supervisor by assigning a different address to masters in the direction of the supervisor network.

When jumper J2 is not mounted, the address set on rotary switch SW3 is the same for internal and external network, and is also set on parameter M19. Connection to supervisor system can be faster for several internal networks as it is not necessary to set external address with parameter M19.



For higher number of internal networks to connect to supervisor, external address of each master unit must be set by repeating the procedure below:

- mount jumper J2 on master unit. If a THS2 is connected to the master unit set parameter *M 19* to the new address and exit parameter setting to transfer new value to the master unit.

J2		OFF (Ext Adr = Int Adr = SW3)
J2		ON (Ext Adr = M19)

- if no THS2 is connected to the master, connect this master to supervisor using address set on rotary switch (default baud rate=19200 bit/s and even parity) with connector CN5 (the other masters must be left unconnected) and repeat the following procedure:

- set 22222 to the variable `STATUS_PRESENCE_SUPERVISOR_DISPLAY` (11033)
- set new address on variable `ADR_MOD_MODBUS_ADDRESS_NETWORK` (11149).

After this new address is considered by the master, this one must be used to communicate with supervisor.

Do not assign a same address to several master units, otherwise communication could not take place correctly.

Example of assignment done for the following network:

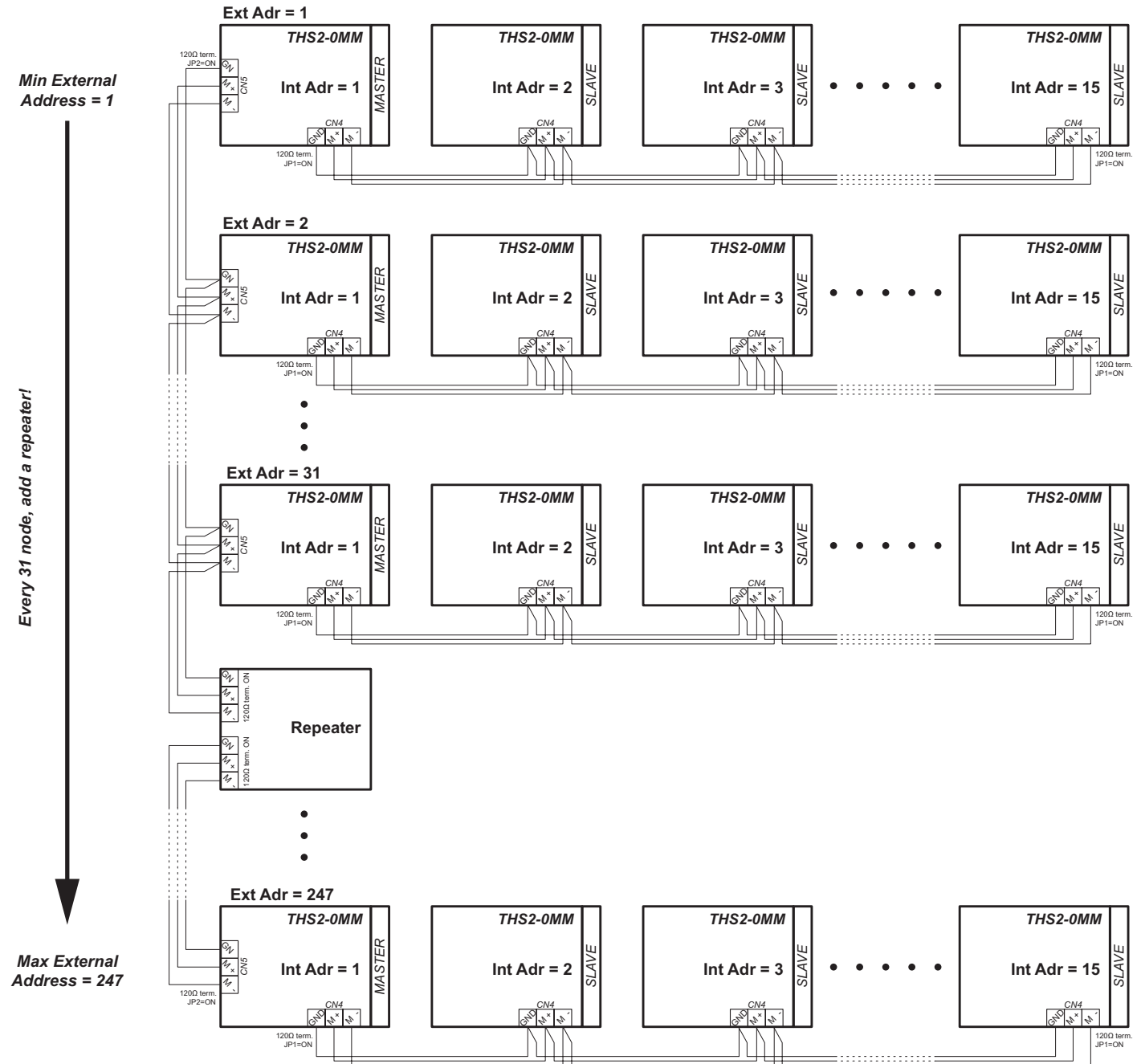

It is necessary for supervisor to communicate with each master with a time laps lower than 10 minutes otherwise supervisor could not be seen as connected and master could not take into consideration eventual data delivered by supervisor for operating. To indicate its presence the variable `STATUS_PRESENCE_SUPERVISOR_DISPLAY` (11033) must be written with the value 22222.

The external RS485-MODBUS line has a bus that is isolated from the internal networks along which masters are directly connected (**max 31 masters without repeater**).

In case of connection of up to 31 masters on the external networks no repeater is necessary.

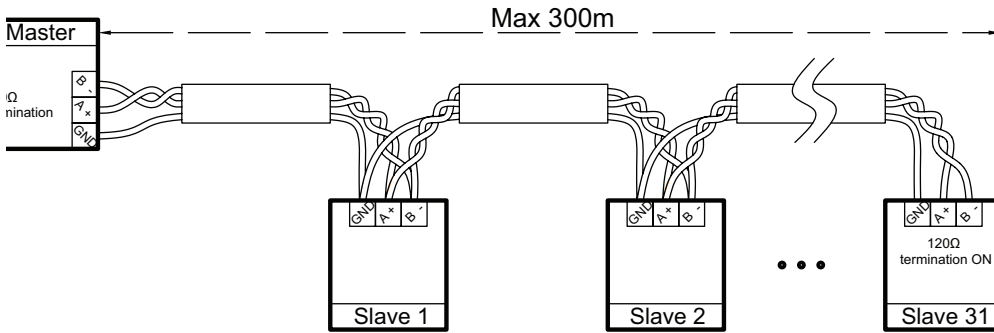

To increase the number of devices connected to the line or to increase the cable length, a signal repeater must be connected. Add one signal repeater for each group of 31 connected masters.

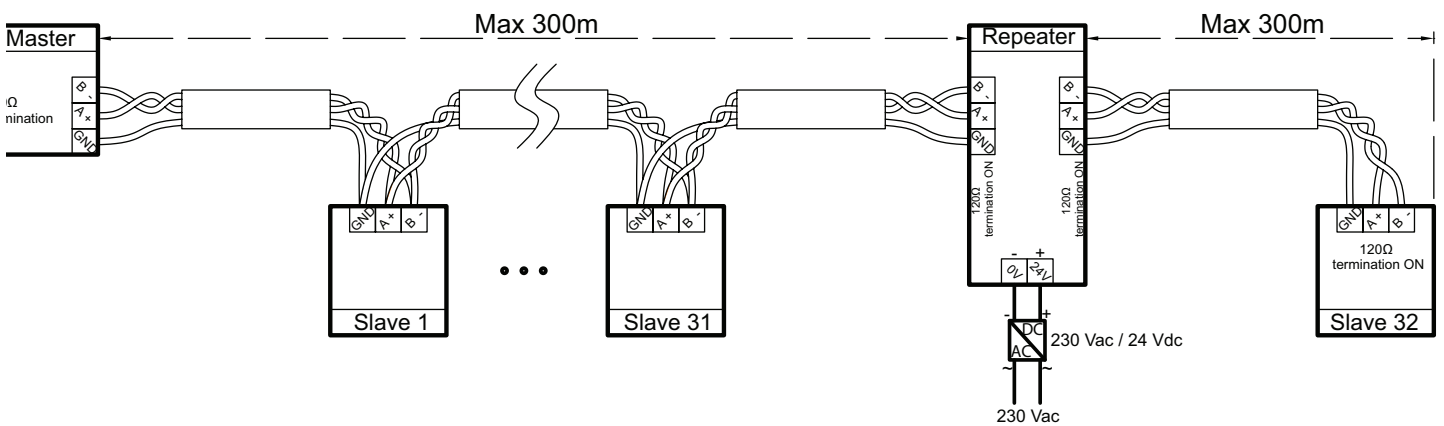

Use cables with a twisted pair + 1 wire for ground + shield.

Use the twisted pair to connect **M+** and **M-** and the single wire for the **GN** which must be connected to each device.

Connect the shield to ground at a single point on the cable as close to the supervisor as possible.

The type of cable must comply with the properties required for data transmission over MODBUS RS485 protocol. Use a Belden 3106A type cable.

The two bus ends must be connected with a 120 ohm termination resistance.

To insert the 120 ohm resistance on the controller, see ["50. Jumper configuration" page 86](#).

The maximum bus length depends on baud rate and on the cable length.

For a baud rate of 19200, the maximum cable length can reach 1000 m with an AVG26 cable.

Any derivations that are used must be short and must not exceed 20 m. With a multi-port tap used for n derivations, each derivation must have a maximum length of 40 m divided by n.

• Connection between optional THS2 to THS2-0MM

It is possible to connect a THS2 on a THS2-0MM (master or slave) using connector CN5. **Terminals GN and GND must be connected together.**

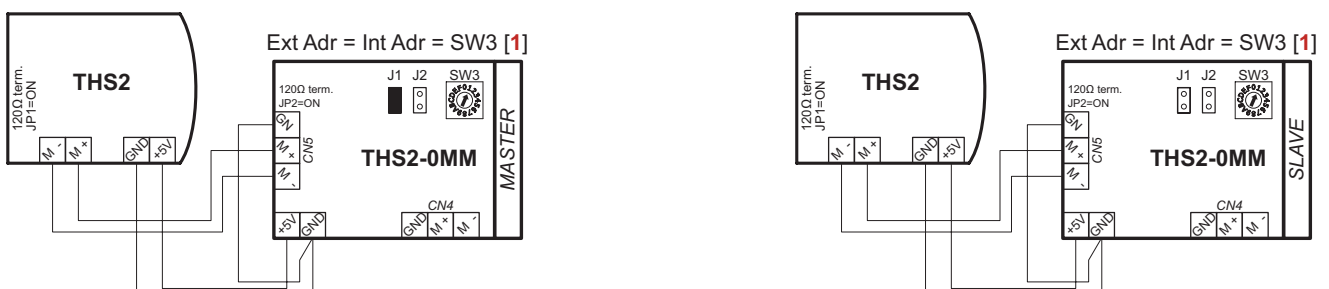

The maximum distance (m) between master THS2 and THS2-0MM can be calculated with the following formula: $[3.2462 / Rdc]$ with Rdc =resistance of the cable (Ohm/m)

55. Dimensions

• THS2-0MM unit

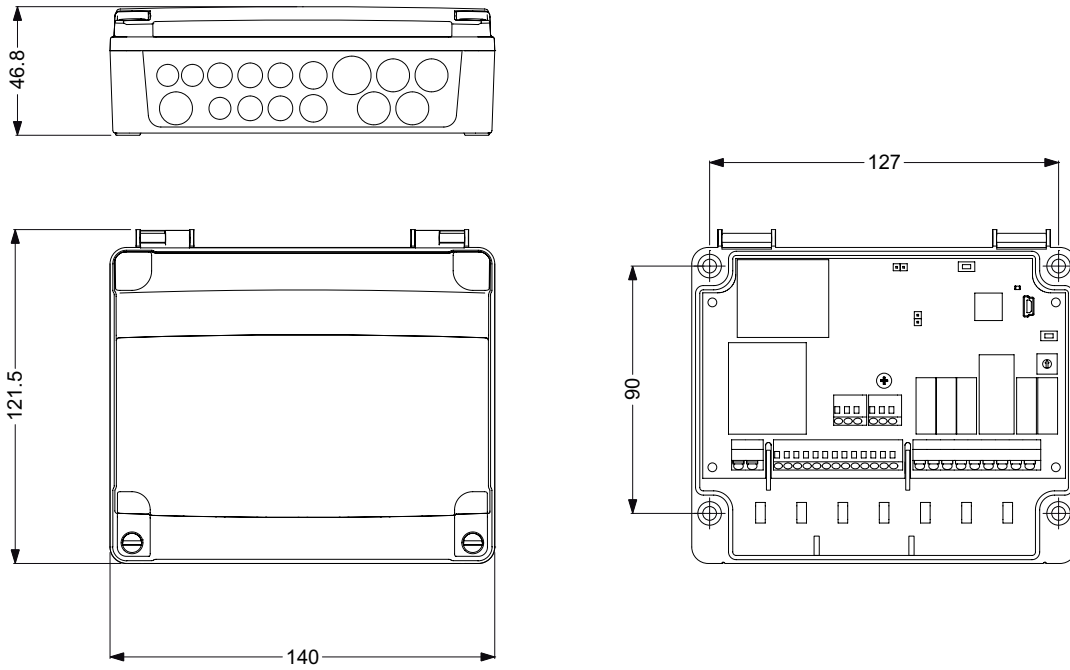

• THS2 unit

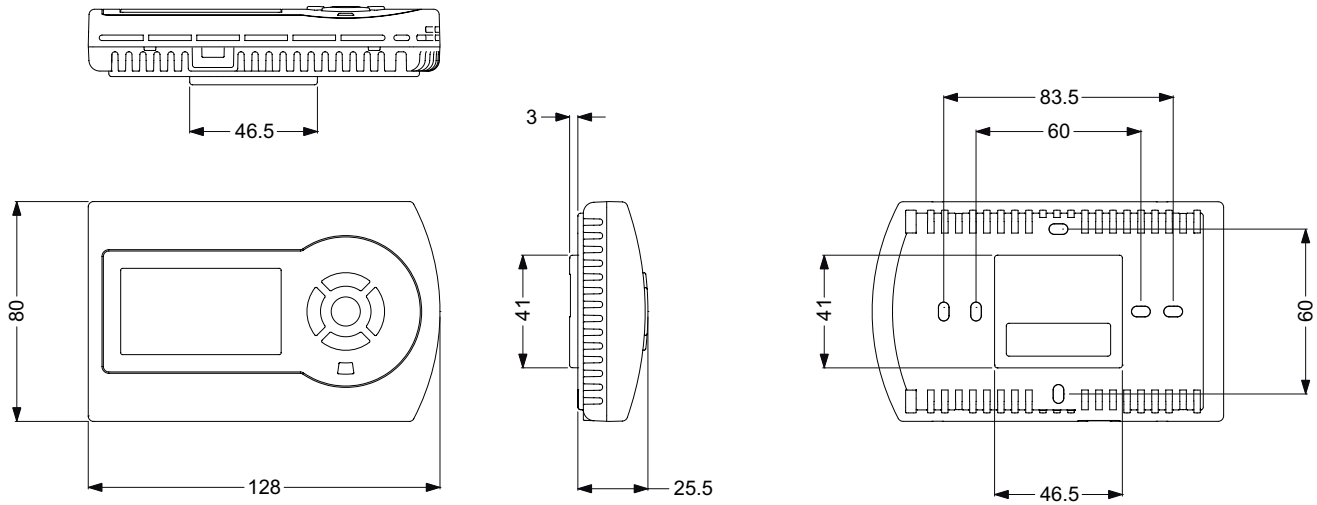

56. Installation requirements

Mount the unit in a place away from heat sources and free of direct draughts at a height of approx. 1.5 m above the floor. Do not install the thermostat on particularly cold or hot walls or on walls that are directly in contact with the outside.

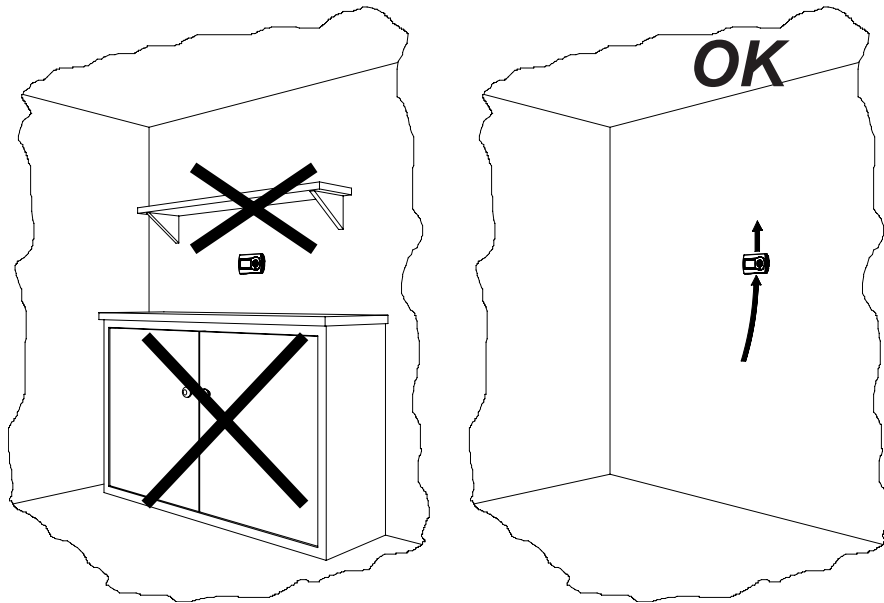
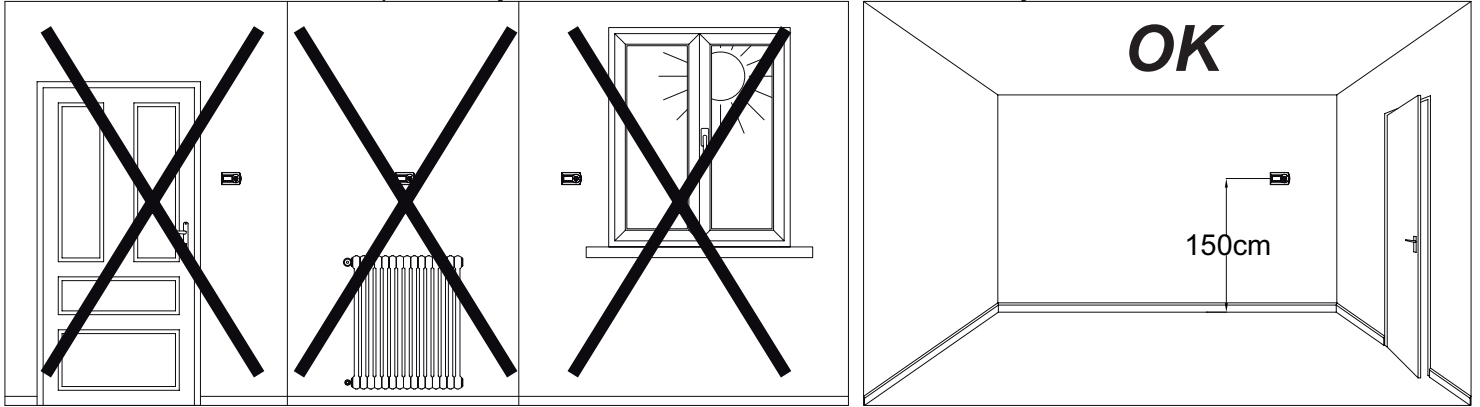

• THS2-0MM unit installation

1

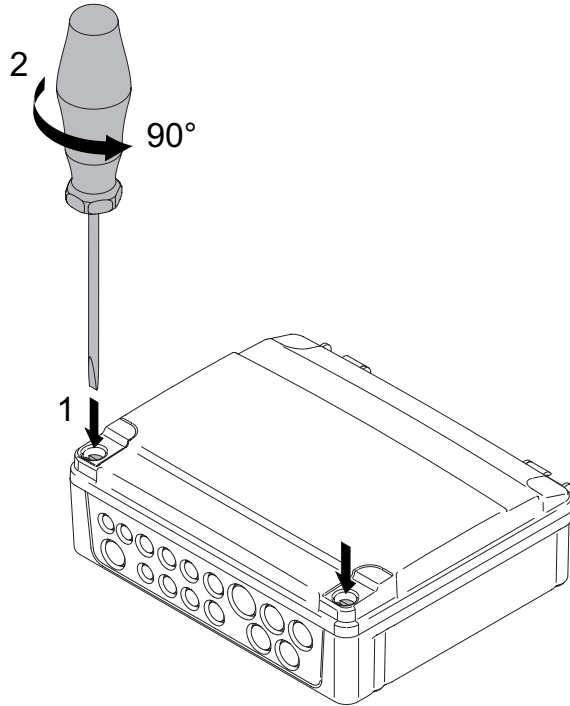

2

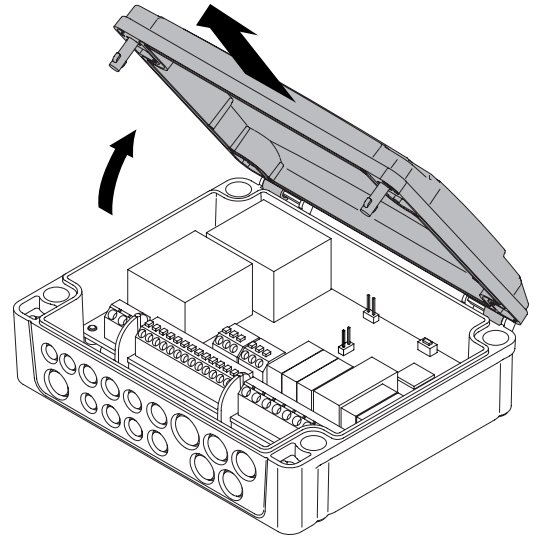

3

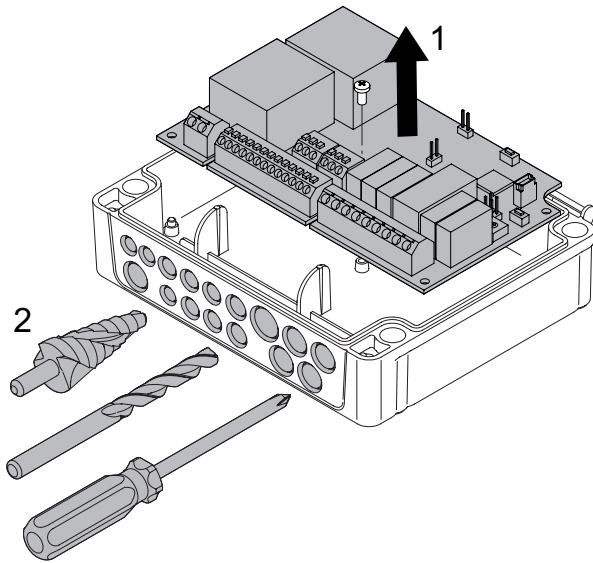

4

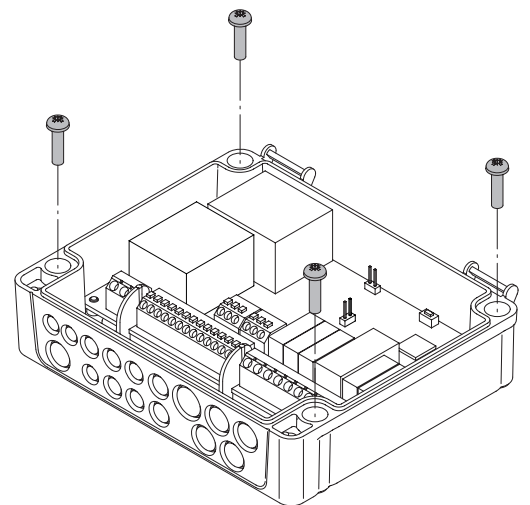

• THS2 unit installation

1

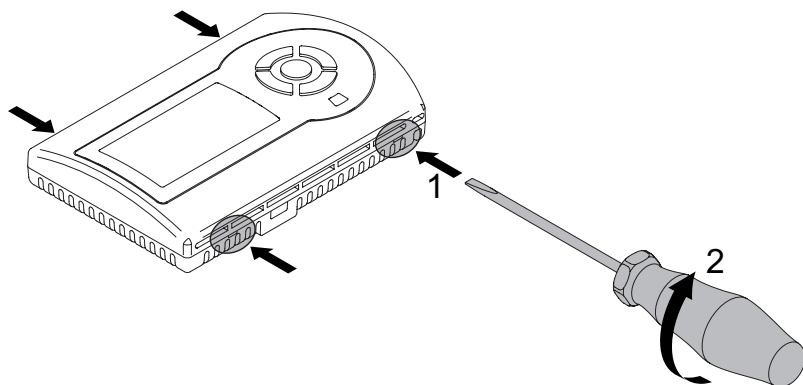

2

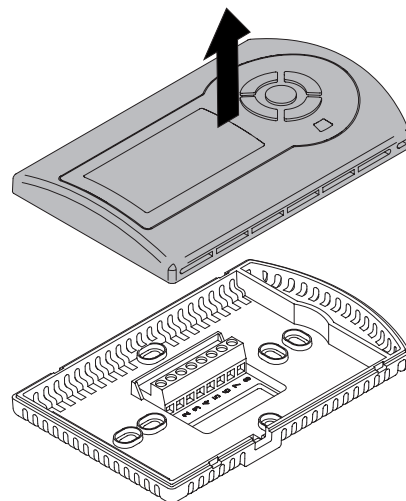

3

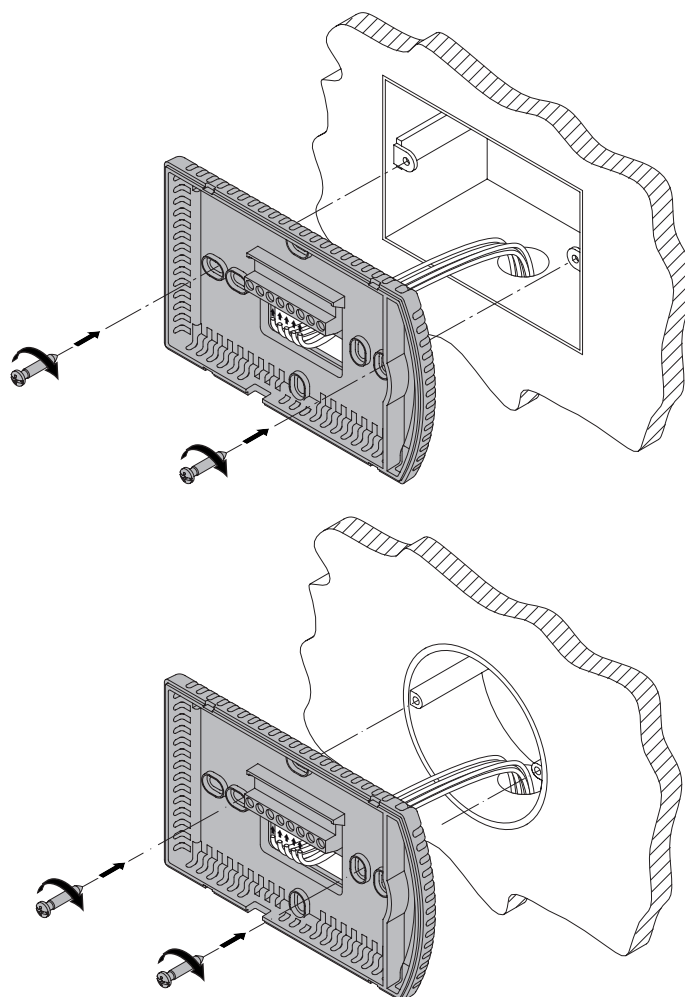

Wall mounting

- Spacing between 83.5 mm fixing holes with box for example: Bticino 503E
- Spacing between 60 mm fixing holes with round box for example: Gewiss GW 24 232

4

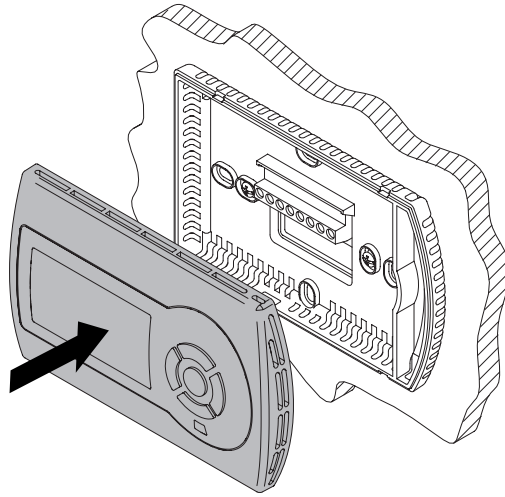



industrie
technik®

