



Evolution AHU

Room controller for air handling units

Room controller for air handling units, equipped with rapid access buttons for the most common functions.

- Communication via RS485 (Modbus)
- Quick and secure settings with the Evolution tool
- Easy installation
- On/Off control or 0...10 V
- Keycard input, window contact, CO₂ sensor and season change function
- 24hr Clock
- Backlit display
- Different types of air handling units can be managed

Applications

Evolution controllers are used for air climate control in buildings, in order to optimize energy consumption and comfort (for example, in offices, schools, shopping centres, airports, hotels, hospitals etc.).

Evolution

Controllers of the Evolution series are available in a wide range of functions for controlling heating, cooling and air-conditioning installations. The new room controller Evolution AHU is designed for air handling units.

AHU version

Room controller for air handling units. The wide availability of inputs and outputs makes it ideal for various types of systems: supply air temperature control, supply

air temperature control with outside temperature compensation, return or ambient air temperature control with supply limitations, monitoring of ambient air temperature using cascade control, monitoring air quality, dehumidification, free cooling, free heating, heat recovery. The outputs can be on / off or modulating. The large backlit display is easily readable and allow you to read the measured values of humidity and temperature, control parameters, time slots of operation and the status of the device. It has also a RS485 communication port with Modbus RTU slave protocol, designed for wall installation on 3 modules box. Depending on the model, the regulators may have a communication function, clock, on / off or proportional control, humidity sensor and a CO₂ sensor input.

MAIN OFFICE BRESSANONE

I-39042 Bressanone (BZ)
via Julius-Durst-Str. 70
VAT No. IT02748450216

tel: +39 0472 830626
fax: +39 0472 831840
www.industrietechnik.it

Evolution AHU

Sensors

The controller is equipped with an internal temperature sensor. Moreover, up to 3 external NTC10K sensors can be connected. An active sensor can be connected to an input in order to read CO₂ values or the humidity level (in that area).

Actuators, fans and dampers

AHU is able to control valve actuators and dampers, proportionally or on/off (with 2-point control), traditional fans with 3-speed or with inverter.

Flexible communication

AHU can be connected to a BMS system via RS485 (Modbus) and set for a particular application using the free Evolution software tool.



Evolution tool

The Evolution tool is a PC software that enables quick and easy configuration of the controller. The software can be downloaded for free from our website www.industrietechnik.it.

Installation

EASY TO INSTALL

The modular design, with extractable clamps for connections, makes the entire Evolution series easy to install. The base can be installed separately from the electronic components. Assembly in a flush-mounting box.

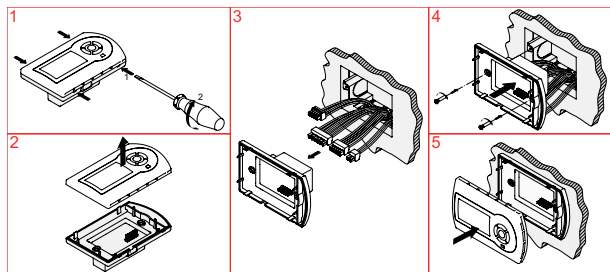

DISPLAY AND TOUCH KEYS

The most common functions can be used by the mere touch of a button. All other functions are available via the menu. The display has the following indications:

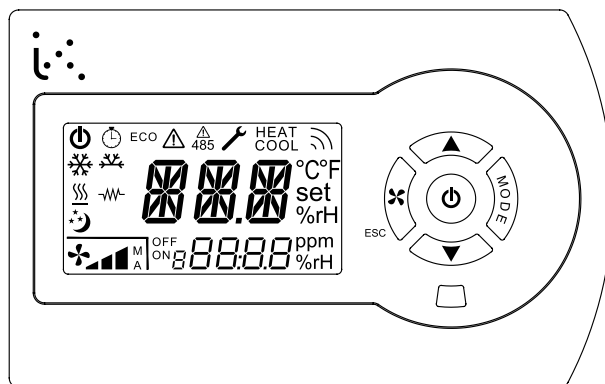

CLOCK AND TIME ZONES

The AHU controller can be fitted with a clock and set in 4 time bands per day for normal or reduced operation (economy or holidays), or for the start-up / shutdown of the system.

MODBUS PORT

The Modbus port can be used to establish the settings and feature a simulation of them by using the Evolution software tool.

USB PORT

By using the USB port (type mini B) and the Evolution tool, you can both update the firmware and set the controller, without power supply.

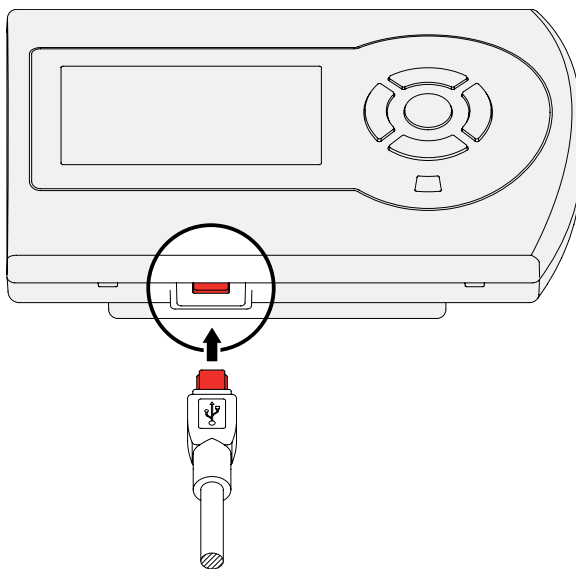

MAIN OFFICE BRESSANONE

I-39042 Bressanone (BZ)
via Julius-Durst-Str. 70
VAT No. IT02748450216

tel: +39 0472 830626
fax: +39 0472 831840
www.industrietechnik.it

Evolution AHU

MAIN FEATURES

AHU can be set for different types of control:

- Control of supply air temperature
- Control of supply air temperature with outdoor temperature compensation
- Control of extract air or room temperature with flow limits
- Air temperature control with cascade control
- Air quality control
- Dehumidification
- Free-cooling
- Free-heating
- Heat recovery
- Dirty filters management
- Control of dampers, on/off or modulating
- Automatic daylight saving time update feature
- Comfort function
- Alarm function (display only)
- Frost protection function by remote contact or probe
- Clock for economy mode or system start-up / shutdown
- Modulating fan or ON / OFF
- Manual configuration via the display and keypad
- Configuration via PC -> Evolution tool for air handling units

MAIN OFFICE BRESSANONE

I-39042 Bressanone (BZ)
via Julius-Durst-Str. 70
VAT No. IT02748450216

tel: +39 0472 830626
fax: +39 0472 831840
www.industrietechnik.it

Evolution AHU

Examples of application

AHU-1XXST1

The system below can be adjusted according to the ambient temperature using the internal probe of the controller (T2), via room sensor (T2) or duct sensor (T1) mounted on the recovery duct. You can set limits on the supply flow using the T3 probe to avoid sudden temperature changes in the environment. The ventilation may be modulating or on / off.

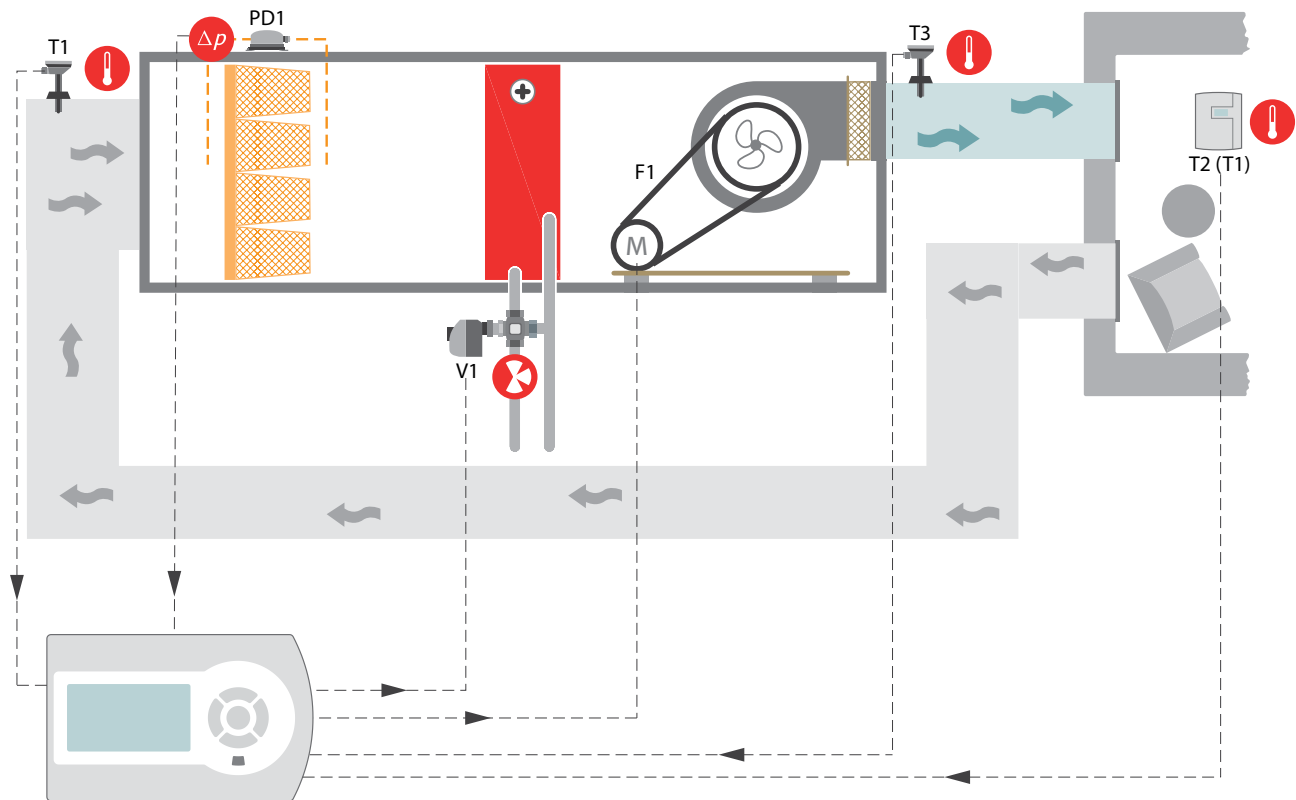

MAIN OFFICE BRESSANONE

I-39042 Bressanone (BZ)
via Julius-Durst-Str. 70
VAT No. IT02748450216

tel: +39 0472 830626
fax: +39 0472 831840
www.industrietechnik.it

Evolution AHU

AHU-3XXST1

The system below can be set according to the ambient temperature using the internal probe of the controller, via room sensor (T2) or duct sensor (T1) mounted on the air supply duct. You can set limits on the supply flow using the T4 probe to avoid sudden temperature changes in the environment. The T3 probe is used for the setpoint compensation based on the outdoor temperature. Ventilation is on / off. The heating and cooling elements are controlled via modulating valve actuators (V1-V2). The system can be set in free-heating mode or free-cooling to save energy, thanks to the set of three dampers controlled via modulating motors. The dampers M1 and M3 are mounted inverted compared to the damper M2 (M1-M3 closed, M2 open and vice versa), this allows the system to re-use air from the outside (free heating, free cooling) or to take advantage of internal air circulation allowing significant energy savings. A frost protection thermostat is connected to Evolution AHU via a digital input.

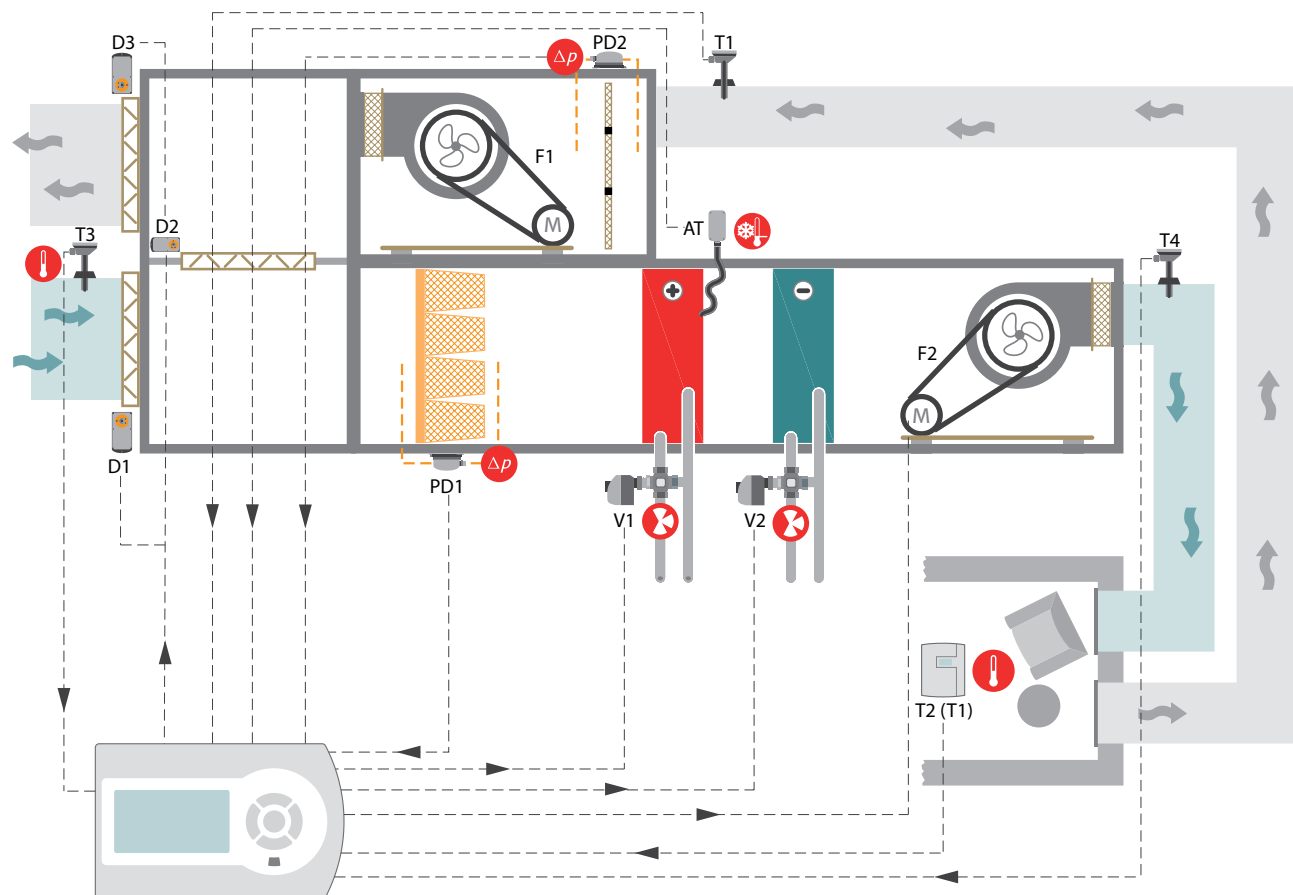

MAIN OFFICE BRESSANONE

I-39042 Bressanone (BZ)
via Julius-Durst-Str. 70
VAT No. IT02748450216

tel: +39 0472 830626
fax: +39 0472 831840
www.industrietechnik.it

Evolution AHU

The system below can be set according to the ambient temperature using the internal probe of the controller (T1), or via duct sensor (T2) mounted on the air supply duct, with possibility of dehumidification (H1). You can set limits on the supply flow using the T2 probe to avoid sudden temperature changes in the environment. The heating and cooling elements are controlled via modulating valve actuators (V1-V2-V3). The system can be set in dehumidification thanks to the sequence of these three elements (heating/cooling/heating). The damper M1 is connected to a digital output (on/off) of Evolution AHU. M1 drives the fan F2 through a switch.

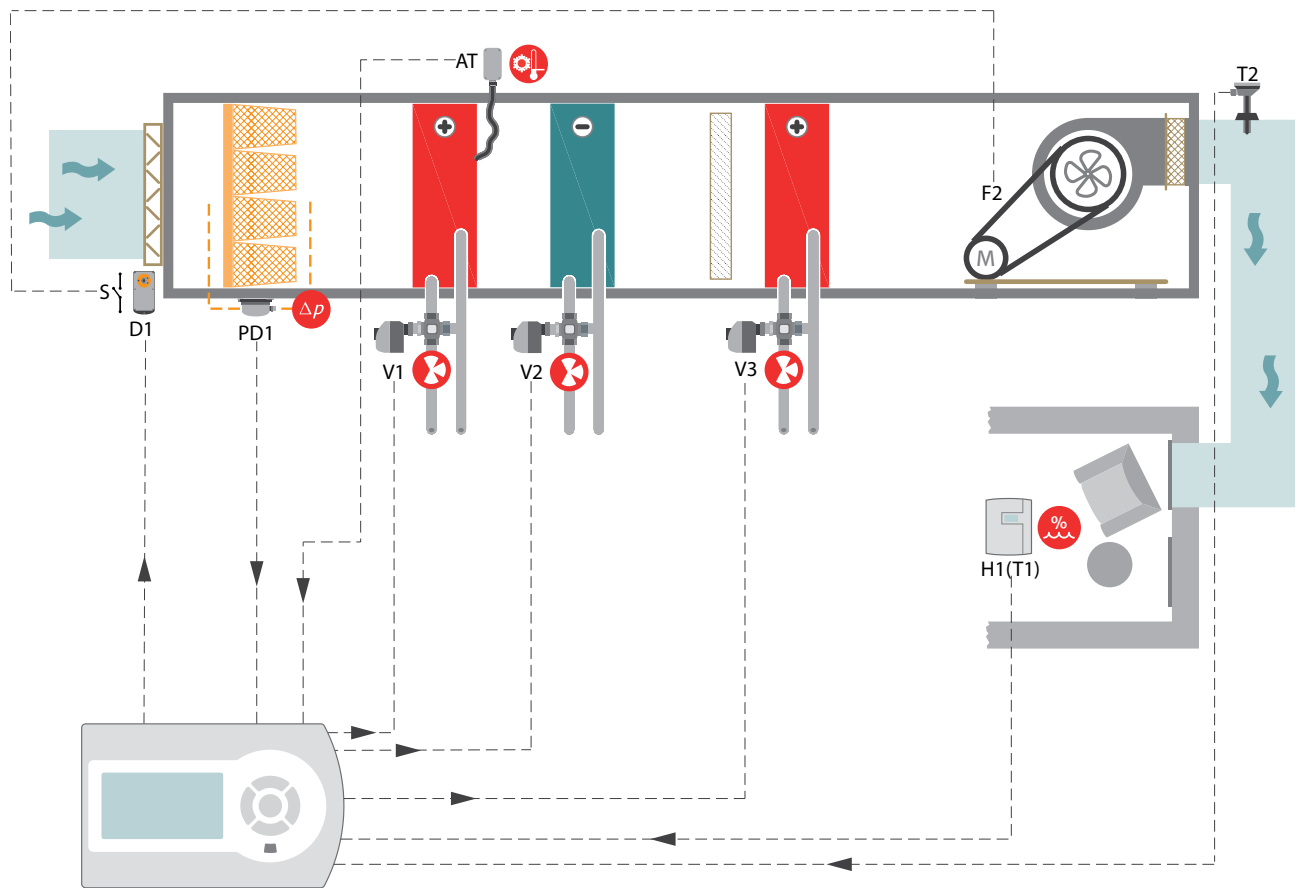

MAIN OFFICE BRESSANONE

I-39042 Bressanone (BZ)
via Julius-Durst-Str. 70
VAT No. IT02748450216

tel: +39 0472 830626
fax: +39 0472 831840
www.industrietechnik.it

Evolution AHU

Technical data

Supply voltage	110...230 V AC \pm 10%, 50...60 Hz
Inputs	2 potential free contacts / 2 or 3 NTC10-02 sensors / USB port for parameters setting and software update
Outputs	3 analogue outputs 0...10 V ($R_L > 10$ kOhm) according to model / 5 relays SPST 230 V AC, 3A (AC1) according to model
Power consumption	Max. 1.3 W
Storage temperature	-20...+70 °C
Temperature range	0...50 °C
Ambient humidity	10...90 % RH (non-condensing)
Display	LCD with backlit
Communication	Modbus RTU (slave)
Range of temperature reading	-15...+90 °C
Mounting	3 modules built-in box
Casing	PC + ABS - White effect RAL 9003
Weight	Max. 230 g
Dimensions	128 x 80 x 55.5 mm
Protection class	IP30
Isolation class	II
Certification	EN 60730-1/A16:2007, EN 61000-6-1:2007, EN 61000-6-3:2007 and EN 60730-2-9:2003. RoHS: This Product complies with the EU directive 2011/65/EU of the European Parliament

Inputs

Analogue inputs (AI)	3 NTC10-02, 0...10 V DC for CO2 or humidity, USB port for parameters setting and software update. The adapted ITK sensors are SA-NTC10-02, NT0220-NTC10-02, SCC-NTC10-02-BR-J, STC-NTC10-02, STCC-NTC10-02.
Digital inputs (DI)	2 potential-free contacts

Outputs

Analogue outputs (AO)	3, 0...10 V ($R_L > 10K$) depending on the model
Digital outputs (DO)	5 SPST relays, 230 V~, 3A (AC1) depending on the model

AHU	X	X	X	S	X	1
Version:						
1 digital output + 3 analog outputs + 3 analog inputs	0					
2 digital outputs + 2 analog outputs + 3 analog inputs	1					
3 digital outputs + 1 analog output + 3 analog inputs	2					
3 digital outputs + 2 analog outputs + 2 analog inputs	3					
5 digital outputs + 0 analog output + 3 analog inputs	4					
Communication:						
Without communication				S		
Modbus				M		
Clock:						
Without clock				S		
With clock				C		
Internal sensor:						
Temperature						T
Temperature + humidity						H
Connector:						
Plug-in connectors						

MAIN OFFICE BRESSANONE

I-39042 Bressanone (BZ)
via Julius-Durst-Str. 70
VAT No. IT02748450216

tel: +39 0472 830626
fax: +39 0472 831840
www.industrietechnik.it

Evolution AHU

Dimensions

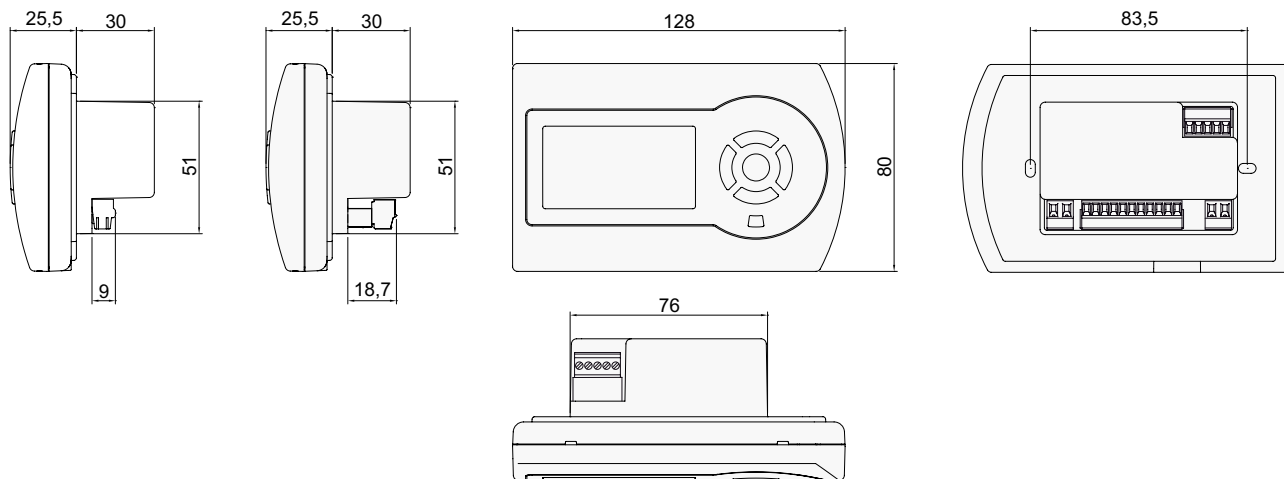

Electrical diagrams

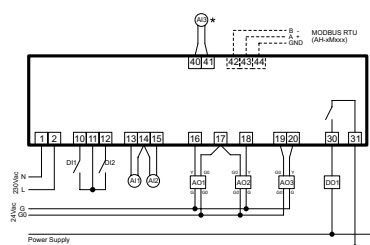

AHU-0xxSx1

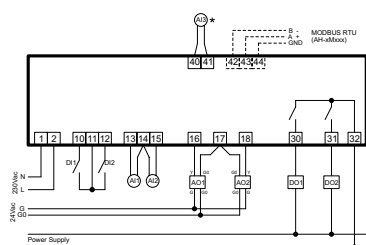

AHU-1xxSx1

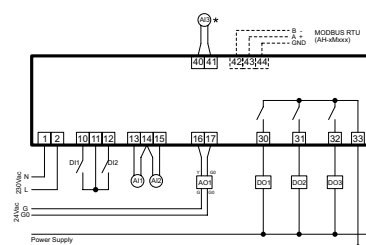

AHU-2xxSx1

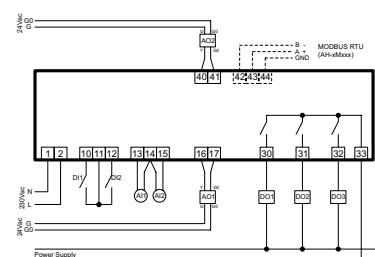

AHU-3xxSx1

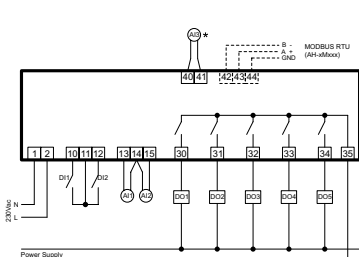

AHU-4xxSx1

For more details of the settings for the inputs and outputs, and other types of air handling units, please read the user's manual available on our homepage: www.industrietechnik.it.

.....

MAIN OFFICE BRESSANONE

I-39042 Bressanone (BZ)
via Julius-Durst-Str. 70
VAT No. IT02748450216

tel: +39 0472 830626
fax: +39 0472 831840
www.industrietechnik.it

Evolution AHU

