

# Products for HVAC/R

## 2022



HEATING



COOLING



VENTILATION



AIR  
APPLICATIONS



WATER  
APPLICATIONS



HUMIDITY



PRESSURE



FLOW



# Table of contents

<b>1</b>	THERMOSTATS AND CONTROLLERS	19
<b>2</b>	ELECTRONIC THERMOSTATS	33
<b>3</b>	ELECTROMECHANICAL THERMOSTATS	43
<b>4</b>	ELECTRIC HEATING CONTROLLERS	55
<b>5</b>	SENSORS, TRANSMITTERS AND SWITCHES	61
<b>6</b>	WIRELESS PRODUCTS	103
<b>7</b>	DAMPER ACTUATORS	107
<b>8</b>	VALVES AND ACTUATORS	117
<b>9</b>	PRESENCE AND SMOKE DETECTORS	161
<b>10</b>	MISCELLANEOUS PRODUCTS	165
	INDEX	169

COMPANY PRESENTATION

P



THERMOSTATS AND CONTROLLERS

1



ELECTRONIC THERMOSTATS

2



ELECTROMECHANICAL THERMOSTATS

3



ELECTRIC HEATING CONTROLLERS

4



SENSORS, TRANSMITTERS AND SWITCHES

5



WIRELESS PRODUCTS

6



DAMPER ACTUATORS

7



VALVES AND ACTUATORS

8



PRESENCE AND SMOKE DETECTORS

9



MISCELLANEOUS PRODUCTS

10

INDEX

I



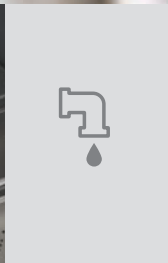
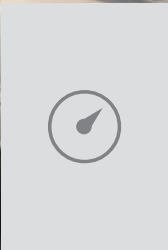
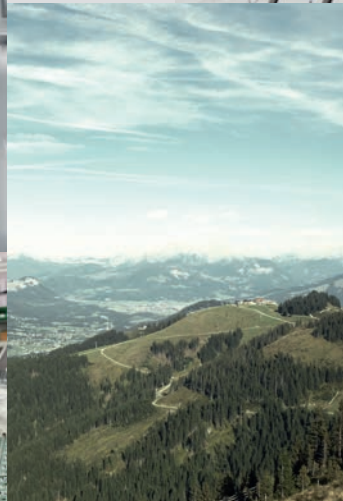
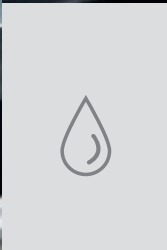
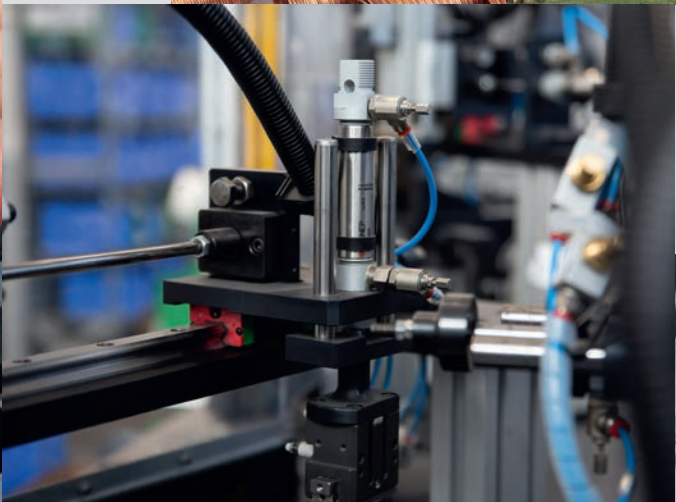
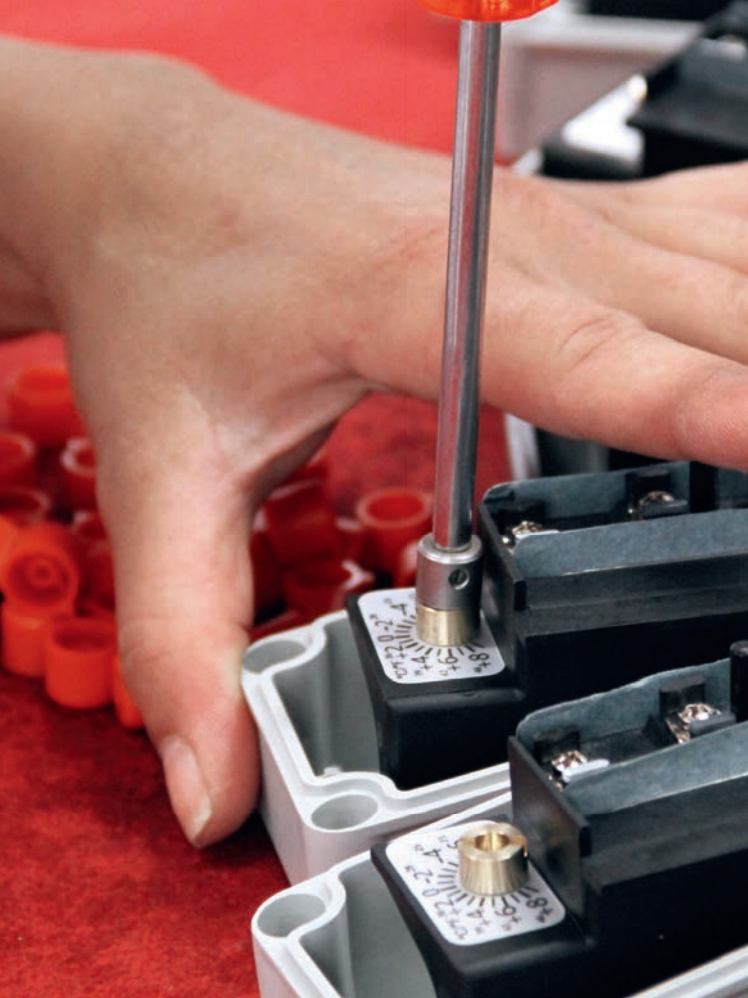



# Industrietechnik – We have been on the market for 40 years

Ever since Industrietechnik was established in 1981, the very foundation of our company has been our ability to listen. In close cooperation with every new customer, we have developed our product range into what it is today - a complete and diverse range of HVAC/R field products for measurement and control in building automation.

Our head office and production site is situated in Brixen, South Tyrol, in the heart of the European Alps at the cultural crossroads of northern and southern Europe. Companies from our region are often known for their quality, long standing experience and extensive know-how. Many businesses in our area are market leaders in their sectors, even in an international context. Our headquarters hosts the sales offices, R&D, our testing facilities and a modern production site with state of the art equipment. This gives us full control over the whole production chain from development and design to production and dispatch.

Today, we are a leading provider of one of the widest ranges of field devices including valves and actuators, electronic and electromechanical devices that can be found on the global market. Together, we sell products to installers, system integrators, wholesalers and OEM-customers in more than 80 countries and we are constantly expanding - and we continue to listen.



# PRODUCT NEWS

# 2022

## Energy-efficient systems. Optimized hydronic flow.

Pressure-independent control valves are the ideal solution for any modern HVAC system. Besides saving operating costs and being easy to install, they reduce pump power and always ensure the correct flow in partial and full load situations. The valves automatically keep the differential pressure on a constant level, no matter the load conditions. This ensures stable and precise temperature control.

At Industrietechnik we provide pressure-independent control valves and matching actuators for reliable and sustainable systems. Our latest addition to the range is the new SEZ2 actuator series. Besides being compatible with most zone valves available on the market, the series fits perfectly with our VFP series of pressure-independent control valves.



### HANDLING THE SYSTEM BECOMES READY STEADY GO.

- Select the valve based on the load requirement.
- Skip KV-, pressure drop-, and valve authority calculations and save hours.
- When the system changes and new zones are added there is no need to rebalance the system.

## We think **bigger** with the new TPDA-12CX



TPDA-12CX is our range of new designed differential pressure transmitters with communication via Modbus. It is based on a sensor technology with among the highest accuracy and long-term stability value on the market. Installation

and setup are easy, and it can optionally be deployed as an expansion unit, optimizing the use of cables. With four additional I/O: s, two universal inputs and two universal outputs, TPDA-12CX offer major expansion possibilities!

PAGE

99

## We expand our DB-TA range with a new controller

Now more efficient, the new DB-TA-385-433 can also control fan-coil applications for EC fans.

### SHORT FACTS:

- Knob for temperature setting
- Manual selection of thermostatic fan/continuous fan/off
- 3 motor speeds, 2 fixed or 1 modulating
- Season changeover
- Internal or remote temperature sensor (optional)



PAGE

29



Meet the leading manufacturer of

# Measurement and control devices for HVAC/R applications

"WE BELIEVE IN PRODUCTS AND SERVICES THAT OUR  
CUSTOMERS CAN RELY ON WITH CONFIDENCE"

COMPANY PRESENTATION



HEATING



COOLING



VENTILATION



AIR  
APPLICATIONS



WATER  
APPLICATIONS



HUMIDITY



PRESSURE



FLOW

We believe in the combination of smart thinking, competence, reliability and the reduction of complexity.

Coming from a multicultural, hard working and ambitious environment, we know that we need to perform outstandingly to succeed on the international market. Industrie-technik was born out of an entrepreneur's dream of developing reliable, quality products to satisfy a big market of HVAC/R customers. He received all the input he needed as he was driving around in his car selling products directly to customers. One of our very first products was a frost protection thermostat - a product that we continue to develop and that is still part of our range.

## Close customer relationships

Today, we no longer ring on doorbells - but we know that good products are born from market input. That's why we've developed a company that builds on close customer relationships and our passion to provide products customers can truly rely on. In order to provide the best service and the right product range we always go back to our core values, the very foundation on which we perform work and conduct ourselves.





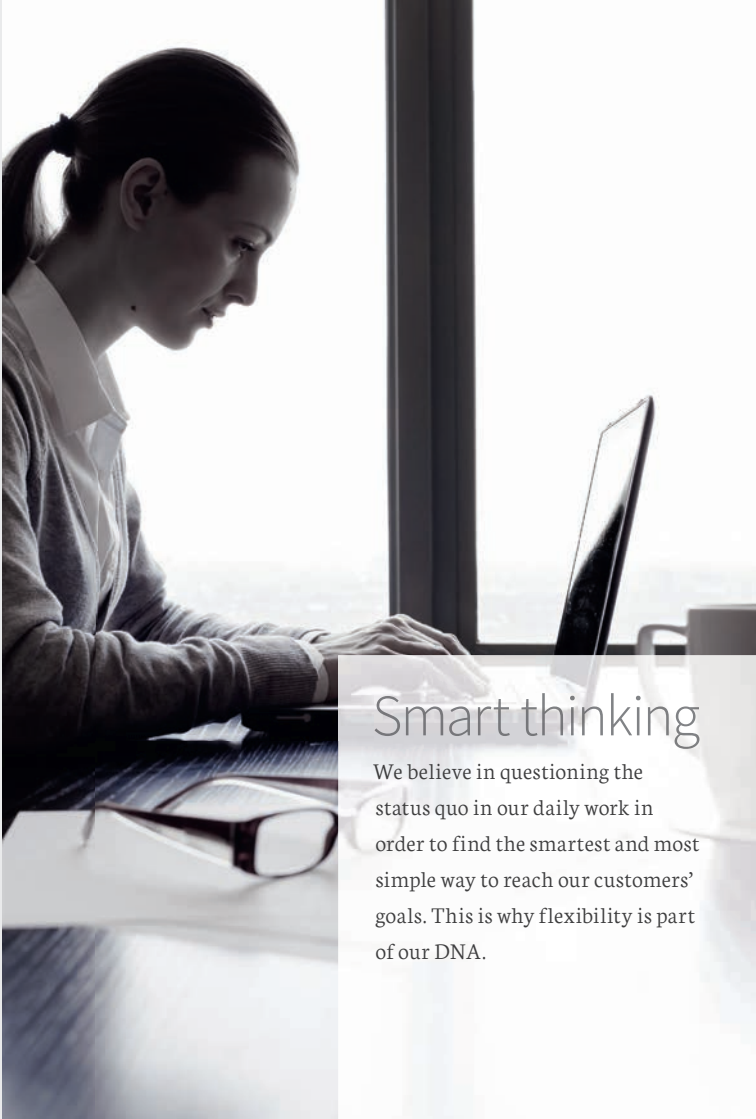

## Smart thinking

We believe in questioning the status quo in our daily work in order to find the smartest and most simple way to reach our customers' goals. This is why flexibility is part of our DNA.



## Competence

We believe that actively gathering knowledge makes us thinkers with a distinctive and informed point of view.



## Reliability

We believe in the simple rule of doing what we say we are going to do, both as individuals and as an organization. We keep our promises.

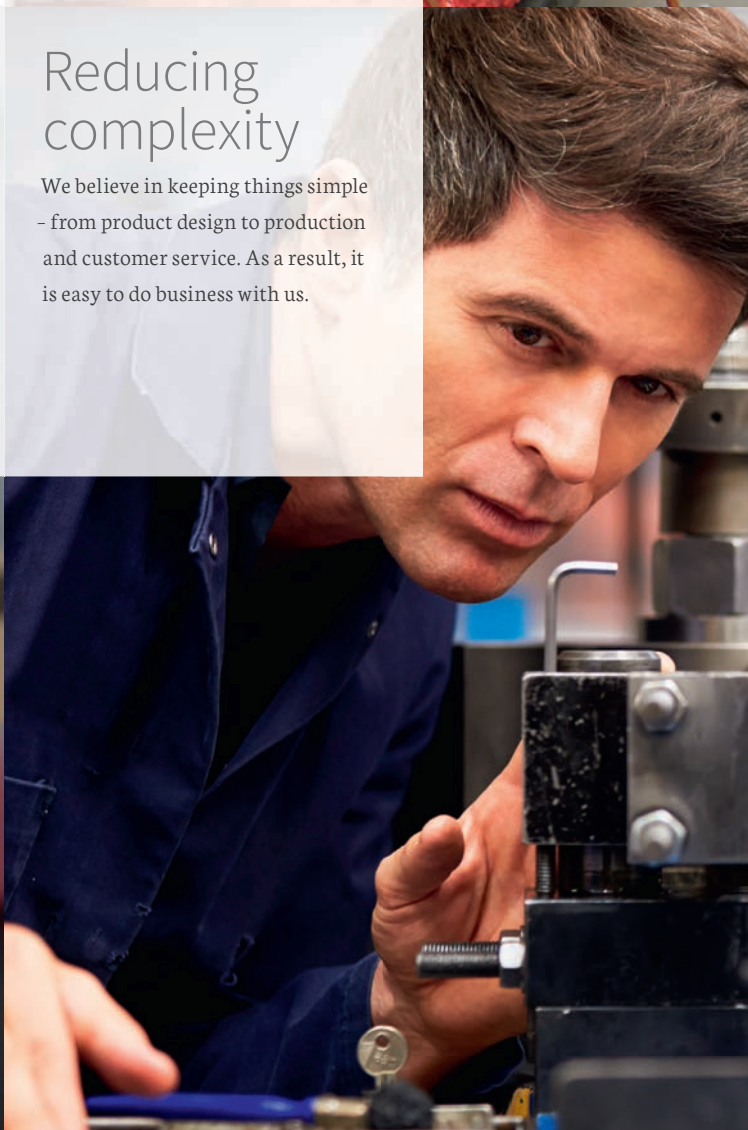

## Reducing complexity

We believe in keeping things simple - from product design to production and customer service. As a result, it is easy to do business with us.

We believe that good products often are born out of frustration with the status quo.

The goal of Industrietechnik is to develop and market a full range of field products necessary for HVAC/R applications. Our comprehensive range includes a complete assortment of valves and actuators as well as electronic and electromechanical devices for reliable measurement and control in building automation.

In the field of liquid flow switches and frost protection thermostats, we are one of Europe's leading companies.

Overall, we cover the complete range of application areas from air-liquid flow and quality, temperature and humidity to pressure.

## Controlling each step in closely knit teams

Our product development is truly customer driven and we control each step of our entire production process, following rigid internal and external standards. In our large-scale testing area every HVAC/R product is repeatedly subjected to extensive tests. We leave nothing to chance and we believe that only in-house tested and retested products are reliable products that our customers can trust.



**Controllers**

**Room controllers  
& Thermostats**

**Switches**

**Transmitters**

**Temperature  
sensors**

**Valves &  
Valve actuators**

**Damper  
actuators**

**Other products**



Electric heating controllers



Evolution - Room controller



Room controllers & thermostats



Electronic controllers & thermostats



Room



Capillary



Duct



Clamp-on



Frost protection



Liquids

Electromechanical thermostats



Pressure



Humidity



Flow



Air flow



Level



Temperature & Humidity



CO<sub>2</sub>



Pressure



Air velocity



CO & VOC



Wireless

PT100  
PT1000  
NTC1.8  
NTC2.2  
NTC10-01  
NTC10-02  
NTC10-03  
NTC15  
NTC20  
NI1000-01  
NI1000-02



Duct



Average



Immersion



Room



Outdoor



Clamp-on sensors



Cable



Heating, cooling & ventilation system



Pressure independent control valves



Butterfly valves



Actuators



Without spring control



With spring return



For fire dampers



Presence protection



Smoke



Transformers



Frost protection unit



Step controllers



We believe that a closely knit organization and smart thinking are essential for the fast and flexible execution of OEM projects.

At Industrietechnik Sales, Purchasing, Development, Finance and Production work side by side. This gives us full insight and control of the entire working process from idea to product and after sales, ensuring quality at every step and on every level of the company. By controlling processes we can plan in advance and optimize our delivery times and at the same time protect customer investments.

This structure makes it possible for us to respond to OEM client demands in a fast and flexible manner. Projects are always coordinated in close cooperation with our customers and in direct communication with our R&D department.

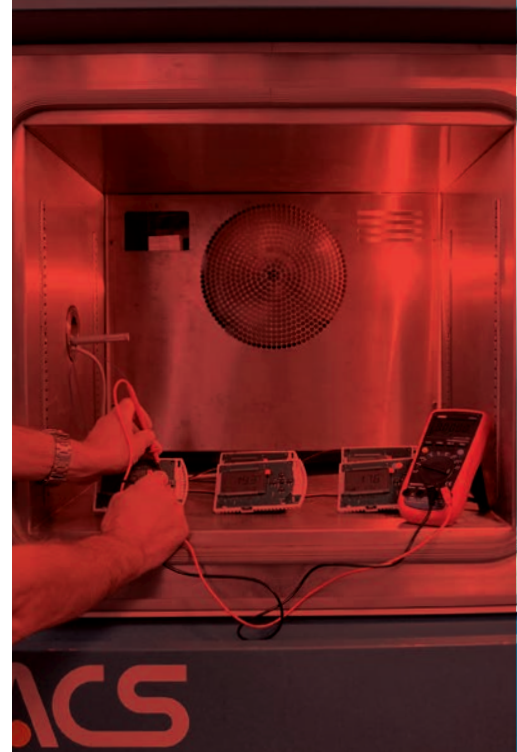



# We are listening.

We can handle all kinds of OEM projects, from product branding to in-house programming of software to adapting our products to the need of your specific application. Moreover, the fact that we have very modern production machinery makes it possible for us to provide branded products that are not part of the standard program - and to do so very quickly. We only work with certified suppliers and can handle both small and large volumes.

## EXAMPLES OF APPLICATIONS THAT OUR PRODUCTS CAN BE FOUND IN:

- Air handling units
- Fan coils
- Chillers
- Heat exchangers
- Ventilation systems
- Air curtains
- Truck refrigerators



YOUR GRAPHICS,  
IN YOUR COLOR OF CHOICE



Our products reach the market through a network of sales teams and distributors in over 80 countries and have been installed in a huge variety of buildings on every continent across the world. This has given us important insights into product development and flexible customer service. Our global markets are served by our international sales force and our warehouse in Bressanone ensures safe and fast deliveries.

Large quantities of our products reach the market in the shape of OEM products with the name of renowned quality brands or integrated into their range.

#### EXPERIENCED IN DELIVERIES

- Short delivery times
- Deliveries in time

# As a global provider we understand the needs of many markets.

**NORFIM OFFICE BUILDING LISBON, PORTUGAL. TURCELL GEBZE OPERATION CENTER GEBZE, TURKEY. VOYAGER MERIT HOTEL-TRNC CYPRUS. PIXEL-34 TBILISI, GEORGIA. HOSPITAL SAN CAMILLO LIDO DI VENEZIA, ITALY. AIRPORT LAMEZIA TERME ITALY. HOSPITAL CASCAIS PORTUGAL. FORTINA HOTEL MALTA. MERIT HOTEL CYPRUS. SAPPHIRE MALL AND RESIDENCE PROJECT TURKEY. MARMARA HOTEL TURKEY. HOSPITAL SAN MARTINO GENOVA, ITALY. SKOPJE AIRPORT SKOPJE MACEDONIA. BOLU HIGHWAY MALL TURKEY. RADISSON HOTEL ISTANBUL, TURKEY. PETITE ENFANCE CAVAILLON, FRANCE. SISLI KULTUR MERKEZI SISLI, TURKEY. RAMADA HOTEL IZMIT IZMIT, TURKEY. APHRODITE HOTEL CYPRUS. STATE HOSPITAL TURKEY. TRM EMERGENCY HOSPITAL TURKEY. HAWLER AIRPORT NORTH IRAQ. KAF HOSPITAL TURKMENISTAN. ENFIDHA AIRPORT TUNISIA. SHANGRI-LA'S MACTAN RESORT & SPA PHILIPPINES. ERBIL DIVAN HOTEL IRAQ. ASHGABAT EYE HOSPITAL TURKMENISTAN. AKU HOSPITAL PAKISTAN PAKISTAN. GALLERIA MALL AMMAN, JORDAN. CENTRAL BANK OF IRAQ IRAQ. BROUGHTON HOSPITAL NORTH CAROLINA, USA.**

# Some of our reference projects world wide.

**Divan Erbil Hotel**  
Erbil, IRAQ



**Medina Airport**  
Medina, SAUDI ARABIA

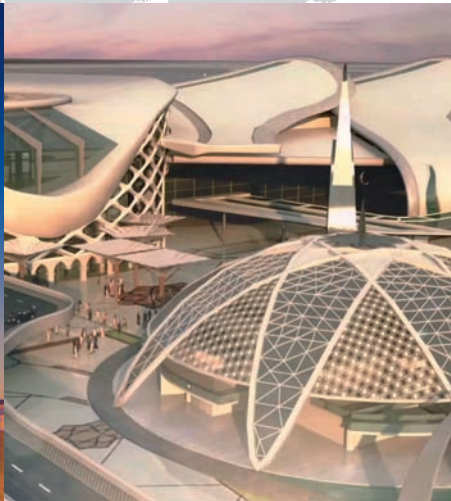

**Central Bank of Iraq**  
IRAQ



**Baku Aquatic Centre**  
ASERBAIDSCHAN



**Hotel Baia Azul**  
Madeira, PORTUGAL



**Sapphire Shopping Center & Residence**  
Istanbul, TURKEY





# 1 Thermostats and controllers

---

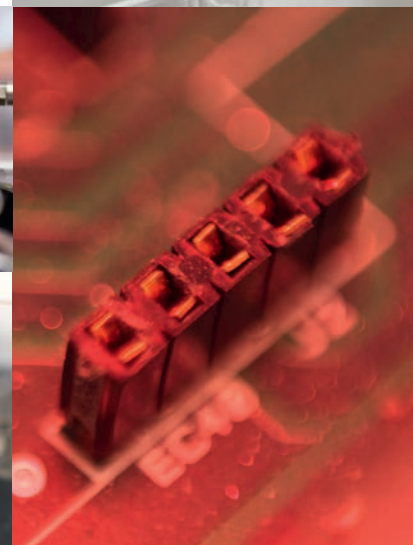
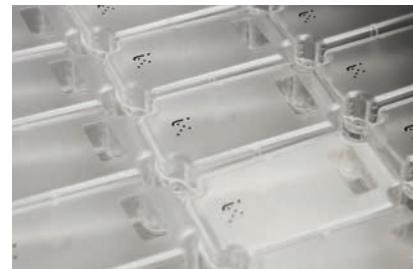

## EVOLUTION TH, PRE-CONFIGURED CONTROLLER WITH DISPLAY, CLOCK AND COMMUNICATION

Controllers of the Evolution series are available in a wide range of functions for controlling heating, cooling and air-conditioning installations. The room controller Evolution TH is well-suited for thermoregulation applications.

Thanks to a large number of I/Os the unit is fit for control of 3-speed or EC fans in 2-pipe, 2-pipe + electric heater, 4-pipe, 4-pipe + electric heater systems. The outputs for valves can be on/off or modulating type. The large backlit display allows user to easily see temperatures, humidity, parameter settings, time bands and the state of the unit. The device is equipped with rapid access keys for the most common functions (fan speed control, season change, on/off etc.). The unit also features an RS485 line with Modbus slave RTU protocol or BACnet MS/TP for external communication and can be built-in wall mounted with a 3-module box. Depending on the model, controllers can have a communication feature, a clock, an on/off or proportional control, humidity sensor and a CO<sub>2</sub> sensor input.



TH



Technical data	
Supply voltage	110...230 V AC ± 10%, 50...60 Hz
Inputs	2 digital contacts free of potential / 2 or 3 NTC10-02 sensors / USB port for parameters setting and software update
Outputs	3 analogue outputs 0...10 V (R <sub>i</sub> > 10 kOhm) according to model / 5 relays SPST 230 V AC, 3A (AC1) according to model
Power consumption	Max. 1.3 W
Temperature range	0...50 °C
Storage temperature	-20...+70 °C
Display	LCD with backlight
Communication	Modbus RTU (slave) or BACnet MS/TP
Range of temperature reading	-15...+90 °C
Mounting	3 modules built-in box
Casing	PC + ABS - White effect RAL 9003
Weight	Max. 230 g
Dimensions	128 x 80 x 55.5 mm
Protection class	IP30
Isolation class	II
Certification	EN 60730-1/A16:2007, EN 61000-6-1:2007, EN 61000-6-3:2007 and EN 60730-2-9:2003. RoHS: This Product complies with the EU directive 2011/65/EU of the European Parliament

### PRODUCT SELECTION

TH-	X	X	X	S	X	1
<b>Version:</b>						
1 digital output + 3 analogue outputs + 3 analogue inputs	0					
2 digital output + 2 analogue outputs + 3 analogue inputs	1					
3 digital output + 1 analogue outputs + 3 analogue inputs	2					
3 digital output + 2 analogue outputs + 2 analogue inputs	3					
5 digital output + 0 analogue outputs + 3 analogue inputs	4					
<b>Communication:</b>						
Without communication				S		
Modbus				M		
Bacnet				B		
<b>Clock:</b>						
Without clock					S	
With clock					C	
<b>Internal sensor:</b>						
Temperature						T
Temperature + humidity						H
<b>Connector:</b>						
Plug-in connectors						

## EVOLUTION SPLIT MASTER UNIT, ROOM CONTROLLER FOR CONTROLLING MULTIPLE FAN COILS VIA SLAVE UNITS

Evolution Split series equipment enables the control of up to 14 fan coils connected to one master unit. The THS2-0MM is a configurable master / slave unit that when configured as master can be connected to other THS2-0MM units configured as slaves. THS2-0MM is equipped with a second Modbus communication port where it can be connected to a Scada system or to the optional THS2 display unit.

The THS2 display can be configured as master unit and connected to a THS2-0MM unit, it allows you to manage all the parameters and view the status of the internal network. With the THS2-0MM unit configured as a slave, it allows the control of only some operating parameters: on / off, setpoint and fan coil speed.

Evolution Split THS2-0MM can manage 3-speed fan coils or fans with EC motor, on / off valves, modulating valves or 3-point valves.



THS2



THS2-0MM

### Technical data, unit THS2

Supply voltage	5 V DC Supplied by THS-0MM slave
Ambient temperature	0...50 °C
Display	LCD with backlight
Inputs	2 potential free contacts / USB port for parameters setting and software update
Communication	internal network
Dimensions (WxHxD mm)	128 x 80 x 28.5
Mounting	wall mounting
Protection class	IP30
Isolation class	II
Certification	EN 60730-1

### Technical data, unit THS2-0MM

Supply voltage	110...240 V AC, 50/60 Hz
Power consumption	Max, 1,1 W (3,5 VA) slave THS-0MM (with power supply for master unit)
Ambient temperature	0...40 °C
Inputs	2 potential free contacts / 2 NTC10K sensors / USB port for parameters setting and software update
Outputs	3 analogue outputs 0...10 V ( $R_L > 10\text{ K}$ ) / 5 relays SPST 250 V AC, 3A (AC1) / 1 relay SPST 250 V AC, 10 A (AC1)
Communication	Modbus RTU (Slave) to BMS and internal network
Dimensions (WxHxD mm)	140 x 121.5 x 47
Mounting	on board fan coil
Protection class	IP30
Isolation class	II
Certification	EN 60730-1



Article	Communication	Internal sensor	AI	DI	AO	DO	Clock
THS2	External network, Modbus RTU (master) Modbus	Temperature + humidity	-	2	-	-	X
THS2-0MM	Internal network and RTU Modbus (slave) to BMS	-	2	2	3	6	-

1

## EVOLUTION AHU, ROOM CONTROLLER FOR AIR HANDLING UNITS

Room controller for air handling units, equipped with rapid access buttons for the most common functions. The wide availability of inputs and outputs makes it ideal for various types of systems: supply air temperature control, the supply air temperature control with outside temperature compensation, shooting or ambient air temperature control with supply limitations, monitoring of ambient air temperature using cascade control (control with flow sensor), monitoring air quality, de-humidification, free cooling, free heating, heat recovery. The outputs can be on / off or modulating. The large backlit display is easily readable and allows to read the measured values of humidity and temperature, control parameters, time slots of operation and the status of the device. It has also a RS485 communication line with Modbus RTU slave protocol, designed for installation on the wall of the box 3 modules. Depending on the model, the regulators may have a communication function, clock, on / off or proportional control, humidity sensor and a CO<sub>2</sub> sensor input.



AHU



Technical data	
Supply voltage	110...230 V AC ± 10%, 50...60 Hz
Inputs	2 potential free contacts / 2 or 3 NTC10-02 sensors / USB port for parameters setting and software update
Outputs	3 analogue outputs 0...10 V (R <sub>L</sub> > 10 kOhm) according to model / 5 relays SPST 230 V AC, 3A (AC1) according to model
Power consumption	Max. 1.3 W
Storage temperature	-20...+70 °C
Temperature range	0...50 °C
Ambient humidity	10...90 % RH (non-condensing)
Display	LCD with backlight
Communication	Modbus RTU (slave)
Range of temperature reading	-15...+90 °C
Mounting	3 modules built-in box
Casing	PC + ABS - White effect RAL 9003
Weight	Max. 230 g
Dimensions	128 x 80 x 55.5 mm
Protection class	IP30
Isolation class	II
Certification	EN 60730-1/A16:2007, EN 61000-6-1:2007, EN 61000-6-3:2007 and EN 60730-2-9:2003. RoHS: This Product complies with the EU directive 2011/65/EU of the European Parliament

## PRODUCT SELECTION

AHU	X	X	X	S	X	1
<b>Version:</b>						
1 digital output + 3 analog outputs + 3 analog inputs						0
2 digital outputs + 2 analog outputs + 3 analog inputs						1
3 digital outputs + 1 analog output + 3 analog inputs						2
3 digital outputs + 2 analog outputs + 2 analog inputs						3
5 digital outputs + 0 analog output + 3 analog inputs						4
<b>Communication:</b>						
Without communication				S		
Modbus				M		
<b>Clock:</b>						
Without clock				S		
With clock				C		
<b>Internal sensor:</b>						
Temperature						T
Temperature + humidity						H
<b>Connector:</b>						
Plug-in connectors						

## EVOLUTION FH, ROOM CONTROLLER FOR RADIANT PANEL APPLICATIONS

Room regulator for regulation and control applications of radiant panel systems. The available functions, including flow temperature control, dew point control, the presence of the relative humidity sensor on board, the management of dehumidification, possibility of using independent time slots by area and much more, make the FH series regulators the optimal choice for the management of heating and cooling systems with radiant panels. The controllers have a Modbus communication port for control in master / slave systems or for interfacing with supervisory systems. The configuration of the products can be done via Modbus port or through a USB port, using the special Evolution Tool configuration software.



FH



1

### Technical data

Supply voltage	110...230 V AC ± 10%, 50...60 Hz
Power consumption	Max. 1.3 W
Temperature range	0...50 °C
Inputs	2 potential free contacts / 2 or 3 NTC10K sensors / USB port for parameters setting and software update
Outputs	1 analogue outputs 0...10 V ( $R_L > 10 \text{ k}\Omega$ ) according to model / 3 or 5 relays SPST 250 V AC, 3A (AC1) according to model
Communication	Modbus RTU (master or slave)
Range of temperature reading	-15...+90 °C
Ambient humidity	10...90 % RH (non-condensing)
Dimensions	128 x 80 x 55.5 mm
Mounting	3 modules built-in box
Storage temperature	-20...+70 °C
Casing	PC + ABS - White effect RAL 9003
Weight	Max. 230 g
Protection class	IP30
Isolation class	II
Certification	EN 60730-1, EN 61000-6-1, EN 61000-6-3

### PRODUCT SELECTION

Room controller:

**FH**

**X M X S H 1**

**Model:**

3 digital outputs + 1 analogue output + 3 analogue inputs

**2**

5 digital outputs + 0 analogue outputs + 3 analogue inputs

**4**

**Communication:**

Modbus

**M**

**Clock:**

Without clock

**S**

With clock

**C**

**Internal sensor:**

Temperature + humidity

**H**

## ROOM TEMPERATURE, HUMIDITY, CO<sub>2</sub> AND UNIVERSAL CONTROLLER 110...240 V AC

Stand-alone room controller for temperature, humidity, CO<sub>2</sub> and universal.



PC-H, PC-U



PC-T, PC-TC

Technical data	
Supply voltage	110...240 V AC, 50...60 Hz
Input	1 analogue input 0...10 V (only for model PC-U)
Output	1 analogue output 0...10 V ( $R_L > 10 \text{ kOhm}$ )
Ambient temperature	0...50 °C
Ambient humidity	10...90 % RH (non-condensing)
Working range, temperature	0...50 °C
Working range, humidity	0...100 % RH
Working range, CO <sub>2</sub>	0...2000 ppm
Protection class	IP30 class II
Dimensions	PC-H, PC-U: 85 x 100 x 30.5 mm PC-T, PC-TC: 88 x 100 x 30.5 mm

Article	Description	Power consumption
PC-H	Room humidity controller	Max. 0.46 W
PC-T	Room temperature controller	Max. 0.46 W
PC-TC	Room temperature and CO <sub>2</sub> controller	Max. 1.25 W
PC-U	Universal room controller	Max. 0.46 W

## ROOM TEMPERATURE CONTROLLER FOR 0...10 V DC OR 3-POINT ACTUATORS

This room controller is primarily intended for control of heating or cooling in zone control systems. It has an input for a presence detector (occupancy control). The controller also has an input for change-over, which makes it possible for the control function to switch between heating and cooling.



CA1

Technical data	
Supply voltage	24 V AC, $\pm 15\%$ 50...60 Hz, 2 VA
Output	0...10 V DC, 1 mA or 3-point, 24 V AC, 1 A
Inputs	Two digital and one NTC sensor
Setpoint	0...40 °C
P-band	0.5...50 K
Dimensions	102 x 120 x 29 mm
Protection class	IP20

Article	Description
CA1	Room temperature controller



## ELECTRONIC ROOM THERMOSTAT, 1-STAGE

Electronic thermostats intended for heating or cooling with built-in sensor and input for an external sensor.



TAE1 TAE2

1

### Technical data



Supply voltage	230 V AC $\pm$ 15 %, 1 VA
Outputs	16 A, 230 V AC, change-over relay
Ambient temperature	0...50 °C
Sensor inputs	NTC sensor
Mounting	Wall
Dimensions	86 x 86 x 30 mm
Protection class	IP30

Article	Temperature range	Hysteresis
TAE1	0...30 °C	1 K
TAE2	20...50 °C	1...10 K

## DB-TA ROOM CONTROLLERS WITHOUT DISPLAY

RANGE +5...+30°C DB-TA-		PIPE	OUTPUTS		SWITCHES			REMOTE S/W	REMOTE SENSOR	POWER SUPPLY
			RELAY	0... 10 VCC	ON/OFF	3-SPEED	S/W			
323-	435	2	•		s	•		•	A	24/230 V AC
335-	993	2/4		•/••			•/zn		B	24 V AC
343-	139	4	••		•	•	zn		B	24/230 V AC
345-	139	4		••	•	•	zn		B	24 V AC
	199	4		••	•		zn			
	999	4		••			zn			
363-	436	2	•		s	•	auto		A	230 V AC
383-	433	2/4	•		s	•	•		A	24/230 V AC
385-	433	2/4	•		•	•	•		A	230 V AC
387-	866	2	••••			m/a	auto		A	230 V AC

### INDEX FOR MODELS DB-TA-3:

- zn** dead zone
- s** continuous fan/thermostatic fan/off switch
- auto** s/w change over with water sensor
-  on/off/electric heater switch
-  min speed/automatic speed switch
- m/a** min speed/automatic speed switch
- A** sensor NT0220-NTC10-02
- B** sensor NT0220-NTC100

## ROOM THERMOSTATS FOR 2 PIPE SYSTEM



DB-TA-323-435

Technical data	
Supply voltage	24/230 V AC $\pm$ 10 %, 50/60 Hz (selectable by jumper)
Load	Max. 6 A
Output	1 SPDT relay 6 A 24/230 V AC
Power consumption	1 W
Sensor	Thermoresistor NTC 100K (for DB-TA-323-435 -> NTC 10K)
Ambient temperature	0...40 °C
Ambient humidity	10...90 % RH (non-condensing)
Setpoint	5...30 °C (mechanical limitation of the setpoint adjustment)
Hysteresis	0.5 K
Storage temperature	-20...+70 °C
Storage humidity	< 95 % RH
Casing	ABS fireproof according to UL94 V-0 color (RAL 9010)
Weight	210 g
Dimensions	144 x 82 x 27 mm
Protection class	IP30
Isolation class	II

Article	On/off button	3 speeds	Change-over function, season	Sensor
DB-TA-323-435	X	X	Remote	NTA020-027P optional with 2 m cable, selectable by jumper



For DB-TA-323-435 switch off/fan based on temp./continuous fan.

## ROOM CONTROLLERS FOR 2 OR 4 PIPE SYSTEM, 0...10 V OUTPUT



DB-TA-335-933

Technical data	
Supply voltage	24 V AC $\pm$ 10 %, 50/60 Hz
Load	Max. 6 A (speeds)
Output	Proportional 0...10 V DC ( $R_L > 10$ kOhm)
Power consumption	1 W
Sensor	NTC 100K
Ambient temperature	0...40 °C
Ambient humidity	10...90 % RH (non-condensing)
Setpoint	5...30 °C (mechanical limitation of the setpoint adjustment)
Hysteresis	0.5 K
Storage temperature	-20...+70 °C
Storage humidity	< 95 % RH
P-band	1...5 K
Neutral zone	1...4 K
Casing	ABS fireproof according to UL94 V-0 color (RAL 9010)
Weight	210 g
Dimensions	144 x 82 x 34 mm mm
Protection class	IP30
Isolation class	II

Article	3 speeds	Change-over function, season	Sensor
DB-TA-335-933	-	Local S/W (4-pipe) neutral zone	NT0220-NTC100 optional with 2 m cable, selectable by jumper

## ROOM CONTROLLERS FOR 4 PIPE SYSTEM



DB-TA-343-139

Technical data	
Supply voltage	24/230 V AC $\pm$ 10%, 50/60 Hz (selectable by jumper)
Load	Max. 6 A (resistivi)
Outputs	2 SPDT relays 6 A 24/230 V AC
Power consumption	1 W
Sensor	NTC 100K
Ambient temperature	0...40 °C
Ambient humidity	10...90 % RH (non-condensing)
Setpoint	+5...+30 °C mechanical limitation of the setpoint adjustment
Hysteresis	0.5 K
Storage temperature	-20...+70 °C
Storage humidity	< 95 % RH
Neutral zone	1...4 K
Casing	ABS fireproof according to UL94 V-0 color (RAL 9010)
Weight	210 g
Dimensions	144 x 82 x 34 mm
Protection class	IP30 class II
Isolation class	II

Article	On/off button	3 speeds	Change-over function, season	Sensor
DB-TA-343-139	X	X	Local S/W (neutral zone)	NT0220-NTC100 optional with 2 m cable, selectable by jumper

## ROOM CONTROLLERS FOR 4 PIPE SYSTEM, 0...10 V OUTPUTS



DB-TA-345-139

Technical data	
Supply voltage	24 V AC $\pm$ 10%, 50/60 Hz
Load	Max. 6 A (speed)
Outputs	2 proportional 0...10 V DC ( $R_L > 10$ kOhm)
Power consumption	1 W
Sensor	NTC 100K
Ambient temperature	0...40 °C
Ambient humidity	10...90 % RH (non-condensing)
Setpoint	5...30 °C mechanical limitation of the setpoint adjustment
Storage temperature	-20...+70 °C
Storage humidity	< 95 % RH
P-band	1...5 K
Neutral zone	1...4 K
Casing	ABS fireproof according to UL94 V-0 color (RAL 9010)
Weight	210 g
Dimensions	144 x 82 x 34 mm
Protection class	IP30 class II
Isolation class	II

Article	On/off button	3 speeds	Change-over function, season	Sensor
DB-TA-345-139	X	X	Local S/W (neutral zone)	NT0220-NTC100 optional with 2 m cable, selectable by jumper
DB-TA-345-199	X	-	Local S/W (neutral zone)	NT0220-NTC100 optional with 2 m cable, selectable by jumper
DB-TA-345-999	-	-	Local S/W (neutral zone)	NT0220-NTC100 optional with 2 m cable, selectable by jumper



DB-TA-345-199

## ROOM THERMOSTATS FOR 2 PIPE SYSTEM WITH AUTOMATIC SEASON CHANGEOVER



DB-TA-363-436

Technical data	
Supply voltage	230 V AC $\pm$ 10%, 50/60 Hz
Load	Max. 6 A (resistivi)
Output	1 relay 6 A 230 V AC
Power consumption	1 W
Sensor	NTC 10K air sensor and water sensor
Ambient temperature	0...40 °C
Ambient humidity	10...90 % RH (non-condensing)
Setpoint	5...30 °C (mechanical limitation of the setpoint adjustment)
Hysteresis	< 0.5 K
Storage temperature	-20...+70 °C
Storage humidity	< 95 % RH
Casing	ABS fireproof according to UL94 V-0 color (RAL 9010)
Weight	210 g
Dimensions	144 x 82 x 34 mm
Protection class	IP30 class II
Isolation class	II

Article	Manual selection of thermostatic fan/continuous fan/Off	3 speeds	Change-over function, season	Sensor
DB-TA-363-436	X	X	Local S/W auto (season changeover selection, S/W, by water sensor)	NT0220-NTC10-02 optional with 2 m cable, selectable by jumper



Note: The thermostats are supplied with water sensor model NTA020-027P

## ROOM THERMOSTATS FOR 2 OR 4 PIPE SYSTEM



DB-TA-383-433

Technical data	
Supply voltage	24/230 V AC $\pm$ 10%, 50/60 Hz (selectable by jumper)
Load	Max. 6 A
Output	1 relay SPDT 6 A 230 V AC
Power consumption	1 W
Sensor	NTC 10K
Ambient temperature	0...40 °C
Ambient humidity	10...90 % RH (non-condensing)
Setpoint	5...30 °C (mechanical limitation of the setpoint adjustment)
Hysteresis	0.5 K
Storage temperature	-20...+70 °C
Storage humidity	< 95 % RH
Casing	ABS fireproof according to UL94 V-0 color (RAL 9010)
Weight	210 g
Dimensions	144 x 82 x 34 mm
Protection class	IP30 class II
Isolation class	II

Article	Manual selection of thermostatic fan/continuous fan/Off	3 speeds	Change-over function, season	Sensor
DB-TA-383-433	X	X	Local S/W	NTA020-027P optional with 2 m cable, selectable by jumper

## ROOM CONTROLLER FOR 2 OR 4 PIPE SYSTEM, ON-OFF



DB-TA-385-433

Supply voltage	230 V AC $\pm$ 10%, 50/60 Hz
Outputs	Valves: Triac 0.5 A, 230 V AC / Fan: 0...10V V DC (RL > 10 kOhm)
Power consumption	1 W
Sensor	NTC 10K
Ambient temperature	0...40 °C
Ambient humidity	10...90 % RH (non-condensing)
Setpoint	5...30 °C
Storage temperature	-20...+70 °C
Storage humidity	< 95 % RH
Casing	ABS fireproof according to UL94 V-0 color (RAL 9010)
Weight	210 g
Dimensions	144 x 82 x 34 mm
Protection class	IP30
Isolation class	II

Article	Manual selection of thermostatic fan/continuous fan/off	3 speeds	Change-over function, season	Sensor
DB-TA-385-433	x	x	Local S/W	NT0220-NTC10-02 optional with 2 m cable, selectable by jumper

## ROOM CONTROLLERS FOR 2 OR 4 PIPE SYSTEM WITH AUTOMATIC MOTOR SPEED AND SEASON CHANGEOVER



DB-TA-387-866

Technical data	
Supply voltage	230 V AC $\pm$ 10%, 50/60 Hz
Load	Max. 6 A for motor output, valves or electric heater relay
Outputs	8 relays 6 A 230 V AC
Power consumption	1 W
Sensor	NTC 10K air sensor and water sensor
Ambient temperature	0...40 °C
Ambient humidity	10...90 % RH (non-condensing)
Setpoint	Summer: +24 $\pm$ 5 °C / winter: +20 $\pm$ 5 °C (mechanical limitation of the setpoint adjustment)
Storage temperature	-20...+70 °C
Storage humidity	< 95 % RH
Hysteresis	0.5 K
Casing	ABS fireproof according to UL94 V-0 color (RAL 9010)
Weight	210 g
Dimensions	144 x 82 x 34 mm
Protection class	IP30 class II
Isolation class	II

Article	Tubes	On/off/electric heating button	Auto/silence	Change-over function, season	3 speeds	Sensor
DB-TA-387-866		X	X	W/S (working season, W/S, selection by water sensor)	Auto	NTA020-027P optional with 2 m cable, selectable by jumper



Note: The controllers are supplied with water sensor model NTA020-027P.

## DB-TA ROOM CONTROLLERS WITH DISPLAY

RANGE +5...+30°C <b>DB-TA-</b>	PIPE	OUTPUTS			SWITCHES			REMOTE S/W	ECONOMY	REMOTE SENSOR	POWER SUPPLY
		RELAY	0...10 VCC	ON/OFF	3-SPEED	S/W					
33A-	10A	2/4		q	•		par	•	v	A	24 V AC
	13A	2/4		q	•	•	par	•	v		
393-	435	2/4	•		s	•	•			A	230 V AC
3A5-	000	4		••			zn		v	-	24 V AC
3C3-	13A	2	••		•	•	par		v	A	230 V AC
	19A	2	••		•		par		v		
	99A	2	••				par		v		

INDEX FOR MODELS DB-TA-3:

- zn** dead zone
- q** proportional-integral action
- s** continuous fan/thermostatic fan/off switch
- par** setting by keys and display
- A** sensor NTO220-NTC10-02
- v** ECONOMY version:  
replace last number of code with "A"

## ROOM CONTROLLERS FOR 2 AND 4 PIPE SYSTEM WITH ECONOMY FUNCTION, WITH 0...10 V OUTPUT(S)

Proportional integral temperature control in heating, ventilation, refrigeration and air conditioning for typically 2- and 4-pipe fan-coil systems with proportional valves.



DB-TA-33A-10A

Technical data	
Supply voltage	24 V AC ± 10%, 50/60 Hz
Inputs	External contact for economy / external contact or water sensor (NTA020-027P optional) for remote season changeover function (2-pipe)
Outputs	Valves: 1 or 2 0-10 V outputs ( $R_L > 10 \text{ k}\Omega$ ) / speeds: 6 A 24/230 V AC, 50/60 Hz
Power consumption	1 W
Sensor	NTC 10K
Ambient temperature	0...45 °C
Ambient humidity	10...90 % RH (non-condensing)
Setpoint	6...45 °C
Storage temperature	-20...+60 °C
Storage humidity	< 95 % RH
Economy	2 pipes: adjustable range between 6...45 °C (replaced the working setpoint) / 4 pipes: adjustable range between 0...5 °C
P-band	1...30 K
I-time	1...30 minutes
Temperature resolution	0.1 °C
Casing	ABS fireproof according to UL94 V-0 color (RAL 9010)
Weight	220 g
Dimensions	144 x 82 x 34 mm
Protection class	IP30
Isolation class	II

Article	On/off button	3 speeds	Change-over function, season	Sensor
DB-TA-33A-10A	X	-	S / W setting by keys and display	NTO220-NTC10-02 optional with 2 m cable, selectable by jumper



Note: optional water sensor model NTA020-027P.

## ROOM THERMOSTATS FOR 2 OR 4 PIPE SYSTEM

Technical data	
Supply voltage	230 V AC ± 10%, 50/60 Hz
Load	Max. 6 A
Inputs	External contact or water sensor for remote season changeover function (DB-TA-393-436)
Outputs	1 relay SPDT 6 A 230 V AC
Power consumption	1 W
Sensor	NTC 10K
Ambient temperature	0...40 °C
Ambient humidity	10...90 % RH (non-condensing)
Setpoint	5...30 °C adjustment by step of 0.5 °C
Hysteresis	0.5 K
Storage temperature	-20...+70 °C
Storage humidity	< 95 % RH
Casing	ABS fireproof according to UL94 V-0 color (RAL 9010)
Weight	220 g
Dimensions	144 x 82 x 34 mm
Protection class	IP30
Isolation class	II



DB-TA-393-435



DB-TA-393-436

1

Article	Manual selection of thermostatic fan/continuous fan/Off	3 speeds	Change-over function, season	Sensor
DB-TA-393-435	X	X	S / W	NTA020-027P optional with 2 m cable, selectable by jumper
DB-TA-393-436	X	X		NTA020-027P optional with 2 m cable, selectable by jumper



Note: optional water sensor model NTA020-027P.

## ROOM CONTROLLERS FOR 4 PIPE SYSTEM, TWO 0-10 V OUTPUTS

Technical data	
Supply voltage	24 V AC ± 10%, 50/60 Hz
Outputs	Valves: 2 0-10 V outputs ( $R_L > 10 \text{ k}\Omega$ ) / speeds: 6 A 24/230 V AC, 50/60 Hz
Power consumption	1 W
Sensor	NTC 10K
Ambient temperature	0...40 °C
Ambient humidity	10...90 % RH (non-condensing)
Setpoint	5...30 °C
Storage temperature	-20...+70 °C
Storage humidity	< 95 % RH
P-band	1...5 K
Neutral zone	1...4 K
Temperature resolution	0.1 °C
Casing	ABS fireproof according to UL94 V-0 color (RAL 9010)
Weight	220 g
Dimensions	144 x 82 x 34 mm
Protection class	IP30
Isolation class	II



DB-TA-3A5-000

Article	On/off button	3 speeds	Change-over function, season
DB-TA-3A5-000	-	-	Neutral zone



## ROOM THERMOSTATS 2 STAGES WITH ECONOMY FUNCTION

Temperature control in heating, refrigeration and air conditioning for typical fan-coil systems with 2 stages.



DB-TA-3C3-13A



DB-TA-3C3-19A



DB-TA-3C3-99A

### Technical data

Supply voltage	230 V AC $\pm$ 10%, 50/60 Hz
Input	External contact for economy function
Outputs	Valves: 2 relay SPDT 6 A 230 V AC / speeds: 6 A 24/230 V AC, 50/60 Hz
Power consumption	1 W
Sensor	NTC 10K
Ambient temperature	0...40 °C
Ambient humidity	10...90 % RH (non-condensing)
Setpoint	5...30 °C
Step differential	0.5...4 K
Hysteresis	0.5...4 K
Storage temperature	-20...+70 °C
Storage humidity	< 95 % RH
Economy	Adjustable range between 0...5 °C
Temperature resolution	0.1 °C
Casing	ABS fireproof according to UL94 V-0 color (RAL 9010)
Weight	220 g
Dimensions	144 x 82 x 34 mm
Protection class	IP30 class II
Isolation class	II

Article	On/off button	3 speeds	Hysteresis	Sensor
DB-TA-3C3-13A	X	X	0.5...4 K	NTA020-027P optional with 2 m cable, selectable by jumper
DB-TA-3C3-19A	X	-	0.5...4 K	NTA020-027P optional with 2 m cable, selectable by jumper
DB-TA-3C3-99A	-	-	0.5...4 K	NTA020-027P optional with 2 m cable, selectable by jumper

# 2 Electronic thermostats

---

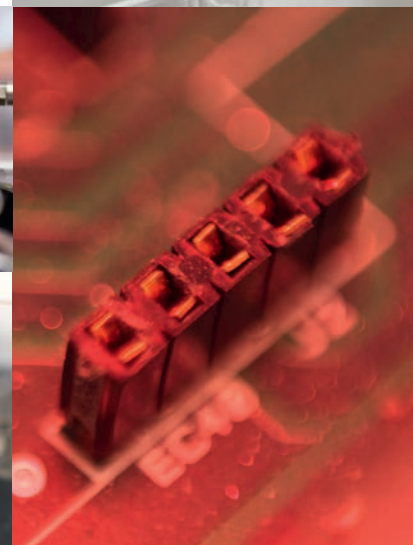
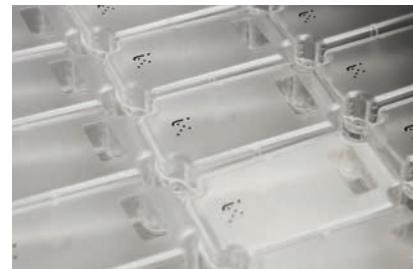

## DIGITAL CONTROLLERS, 4 STAGES WITH RELAY

Temperature and humidity control in heating, cooling, humidification and dehumidification systems.



DB-I4D/02/001

Technical data	
Supply voltage	230 V AC +/- 10%, 50-60 Hz
Input	- NTC 10K sensor and/or humidity-current transmitter 4...20 mA- remote setpoint controller DB-CDP-N1 (optional)
Output	4 or 8 SPDT relays 10 A 230 V AC
Ambient temperature	-10...+50 °C
Ambient humidity	10...90 % RH (non-condensing)
Storage temperature	-20...+70 °C
Storage humidity	< 95 % RH
Delay	0...9.5 min
Display	2 lines with 3 digits (7 segments display)
Configuration	4 push/buttons keyboard on the front
Casing	Makrolon
Weight	920 g
Dimensions	200 x 120 x 75 mm (DB-I4D/02/004: 2 casings 200 x 120 x 75 mm)
Protection class	IP65
Isolation class	II

Article	Power consumption	Number of modules	Steps	Range	Hysteresis	Input
DB-I4D/02/001	< 3 W	1	4	-50...+110 °C	0...10 K	NTC 10K
DB-I4D/02/002	< 3 W	1	4	0...100 % RH	0...100 % RH	4...20 mA
DB-I4D/02/003	< 3 W	1	4	-50...+110 °C / 0...100 % RH	0...10 K / 0...10 % RH	NTC 10K / 4...20 mA
DB-I4D/02/004	< 6 W	2	8	-50...+110 °C	0...10 K	NTC 10K

## DIGITAL THERMOSTAT ONE STAGE

Indication and controlling of temperature with NTC sensors in industrial heating and cooling applications.



DTR11N7

Technical data	
Supply voltage	230 V AC, 50/60 Hz
Input	1 NTC sensor
Output	1 SPDT relay 10 A, 230 V AC resistive load
Sensor	NTC10-02
Power consumption	1,8 W / 2,5 VA
Setpoint	-40...+105 °C
Ambient temperature	0...55 °C
Ambient humidity	10...90% RH (non-condensing)
Storage temperature	-20...+70 °C
Storage humidity	< 95 % RH
Hysteresis	0,1...99 K
Resolution	0,1 °C / 1 °C / 0,1 °F
Casing	Fire-proof
Connection	Screw terminal blocks
Installation	Panel mounting, with click brackets
Dimensions	75 x 33 x 65 mm - mounting hole 71 x 29 mm
Protection class	IP65 (frontal)

Article	Setpoint	Hysteresis
DTR11N7	-40...+105 °C	0,1...99 K

## DIGITAL CONTROLLERS WITH RELAYS

Control of 1 or 2 independent physical quantities with:

- 2 relay outputs;
- 1 output for power supply of active transducer (17 V DC, max. 44 mA);
- 3 digit display;
- red LED, output state indicator;
- push buttons for parameters setting;
- optical alarms;
- password and two access levels.



DB-R/1

### Technical data DB-R/1

Outputs	2 SPDT relays 8 A 230 V AC
Power consumption	< 3 W
Ambient temperature	0...45 °C
Ambient humidity	10...90 % RH (non-condensing)
Storage temperature	-20...+70 °C
Storage humidity	< 95 % RH
Connection	Screw terminal block for cables up to 2.5 mm <sup>2</sup>
Casing	ABS fireproof plastic according to UL94 V-0
Weight	400 g
Dimensions	96 x 48 x 122 mm - mounting hole: 92 x 45 mm
Protection class	IP52 (front)
Isolation class	II

DB-R/1

Part number selection DB-R	Input 1			Input 2			X	1
	X	X	XX	X	X	XX		
<b>INPUT 1</b>								
NTC10-02	1	1	07 <sup>(1)</sup>					
PT1000	2	1	08 <sup>(1)</sup>					
PTC 2K	3	1	09 <sup>(1)</sup>					
NI1000-02	4	1	10 <sup>(1)</sup>					
0...1000 Ohm	5	2	06 <sup>(1)</sup>					
0...1 Vcc (**)	6							
0...10 Vcc (**)	7							
0...20 mA (**) (Rin = 100 Ohm)	8							
4...20 mA (**) (Rin = 100 Ohm)	9							
<b>UNIT 1</b>								
°C		1						
% u.r.		2						
bar		3						
mbar		4						
Pa		5						
m/s		6						
ppm		7						
without unit								
<b>RANGE 1</b>								
0...+50°C			01					
-30...+50°C			02					
-10...+40°C			03					
0...+100°C			04					
-20...+80°C			05					
0...+100% u.r.			06					
-50...+110°C			07					
-60...+600°C			08					
-50...+150°C			09					
-60...+200°C			10					
Range on request (*)			99					
<b>INPUT 2</b>								
None				0	0	00		
NTC10-02				1	1	07 <sup>(1)</sup>		
PT1000				2	1	08 <sup>(1)</sup>		
PTC 2K				3	1	09 <sup>(1)</sup>		
NI1000-02				4	1	10 <sup>(1)</sup>		
0...1000 Ohm				5	2	06 <sup>(1)</sup>		
0...1 Vcc (**)				6				
0...10 Vcc (**)				7				
0...20 mA (**) (Rin = 100 Ohm)				8				
4...20 mA (**) (Rin = 100 Ohm)				9				
<b>UNIT 2</b>								
None					0			
°C					1			
% u.r.					2			
bar					3			
mbar					4			
Pa					5			
m/s					6			
ppm					7			
without unit								
<b>RANGE 2</b>								
None						00		
0...+50°C						01		
-30...+50°C						02		
-10...+40°C						03		
0...+100°C						04		
-20...+80°C						05		
0...+100% u.r.						06		
-50...+110°C						07		
-60...+600°C						08		
-50...+150°C						09		
-60...+200°C						10		
range on request (*)						99		
<b>POWER SUPPLY</b>								
230 Vca ±10% 50/60 Hz							1	
12 Vca ±10% 50/60 Hz							2	
<b>OUTPUT</b>								
2 relè SPDT 230Vca 8A								

(\*) specify on order  
 (1) compulsory ranges  
 (\*\*) the choice of the setting range is only permitted for models with voltage inputs (VDC) or current (mA)



## DIGITAL CONTROLLERS 2 OUTPUTS 0...10 V

Regulation of 1 or 2 independent physical quantities with:

- 2 proportional outputs 0...10 V DC;
- 1 output for power supply of active transducer ( 17 V DC, Max. 44 mA);
- 3 digit display;
- red led, output state indicator;
- push buttons for parameters setting;
- optical alarms;
- password and two access levels.



DB-R/2

### Technical data DB-R/2

Outputs	2 0-10 V ( $R_L > 10 \text{ KOhm}$ )
Power consumption	< 3 W
Ambient temperature	0...45 °C
Ambient humidity	10...90 % RH (non-condensing)
Storage temperature	-20...+70 °C
Storage humidity	< 95 % RH
Connection	Screw terminal block for cables up to 2.5 mm <sup>2</sup>
Casing	ABS fireproof plastic according to UL94 V-0
Weight	400 g
Dimensions	96 x 48 x 122 mm - mounting hole: 92 x 45 mm
Protection class	IP52 (front)
Isolation class	II



DB-R/2

Part number selection		Input 1		Input 2				
DB-R		X	X	XX	X	XX	X	2
<b>INPUT 1</b>								
NTC10-02		1	1	07 <sup>(1)</sup>				
0...10 Vcc (**)		7						
4...20 mA (**) (Rin = 100 Ohm)		9						
<b>UNIT 1</b>								
°C			1					
% u.r.			2					
bar			3					
mbar			4					
Pa			5					
m/s			6					
ppm			7					
without unit								
<b>RANGE 1</b>								
0...+50°C				01				
-30...+50°C				02				
-10...+40°C				03				
0...+100°C				04				
-20...+80°C				05				
0...+100% u.r.				06				
-50...+110°C				07				
-60...+600°C				08				
-50...+150°C				09				
-60...+200°C				10				
range on request (*)				99				
<b>INPUT 2</b>								
None					0	0	00	
NTC10-02					1	1	07 <sup>(1)</sup>	
0...10 Vcc (**) (Rin = 100 Ohm)					7			
4...20 mA (**) (Rin = 100 Ohm)					9			
<b>UNIT 2</b>								
None						0		
°C						1		
% u.r.						2		
bar						3		
mbar						4		
Pa						5		
m/s						6		
ppm						7		
without unit								
<b>RANGE 2</b>								
None							00	
0...+50°C							01	
-30...+50°C							02	
-10...+40°C							03	
0...+100°C							04	
-20...+80°C							05	
0...+100% u.r.							06	
-50...+110°C							07	
-60...+600°C							08	
-50...+150°C							09	
-60...+200°C							10	
range on request (*)							99	
<b>POWER SUPPLY</b>								
230 Vca ±10% 50/60 Hz								1
12 Vca ±10% 50/60 Hz								2
<b>OUTPUT</b>								
2.0-10 V								

(\*) specify on order  
 (1) compulsory ranges  
 (\*\*) the choice of the setting range is only permitted for models with voltage inputs (VDC) or current (mA)



## DIGITAL CONTROLLERS WITH 1 OUTPUT 0...10 V AND 1 RELAY OUTPUT

Regulation of 1 or 2 independent physical quantities with:

- 1 proportional output 0...10 V DC;
- 1 relay output;
- 1 output for power supply of active transducer (17 V DC, Max. 44 mA)
- 3 digit display;
- red led, output state indicator;
- push buttons for parameters setting;
- optical alarms;
- password and two access levels.



DB-R/3

### Technical data DB-R/3

Outputs	1 proportional 0...10 V DC ( $R_L > 10 \text{ k}\Omega$ ) / 1 SPDT relay 8 A 230 V AC
Power consumption	< 3 W
Ambient temperature	0...45 °C
Ambient humidity	10...90 % RH (non-condensing)
Storage temperature	-20...+70 °C
Storage humidity	< 95 % RH
Connection	Screw terminal block for cables up to 2.5 mm <sup>2</sup>
Casing	ABS fireproof plastic according to UL94 V-0
Weight	400 g
Dimensions	96 x 48 x 122 mm - mounting hole: 92 x 45 mm
Protection class	IP52 (front)
Isolation class	II

DB-R/3

Part number selection	Input 1		Input 2				1
DB-R	X	X	XX	X	X	XX	X
<b>INPUT 1</b>							
NTC10-02	1	1	07 <sup>(1)</sup>				
0...10 Vcc (**)	7						
4...20 mA (**) (Rin = 100 Ohm)	9						
<b>UNIT 1</b>							
°C		1					
% u.r.		2					
bar		3					
mbar		4					
Pa		5					
m/s		6					
ppm		7					
without unit							
<b>RANGE 1</b>							
0...+50°C			01				
-30...+50°C			02				
-10...+40°C			03				
0...+100°C			04				
-20...+80°C			05				
0...+100% u.r.			06				
-50...+110°C			07				
-60...+600°C			08				
-50...+150°C			09				
-60...+200°C			10				
range on request (*)			99				
<b>INPUT 2</b>							
None				0	0	00	
NTC10-02				1	1	07 <sup>(1)</sup>	
PT1000				2	1	08 <sup>(1)</sup>	
PTC 2K				3	1	09 <sup>(1)</sup>	
NI1000-02				4	1	10 <sup>(1)</sup>	
0...1000 Ohm				5	2	06 <sup>(1)</sup>	
0...1 Vcc (**)				6			
0...10 Vcc (***)				7			
0...20 mA (**)				8			
4...20 mA (**)				9			
<b>UNIT 2</b>							
None					0		
°C					1		
% u.r.					2		
bar					3		
mbar					4		
Pa					5		
m/s					6		
ppm					7		
without unit							
<b>RANGE 2</b>							
None						00	
0...+50°C						01	
-30...+50°C						02	
-10...+40°C						03	
0...+100°C						04	
-20...+80°C						05	
0...+100% u.r.						06	
-50...+110°C						07	
-60...+600°C						08	
-50...+150°C						09	
-60...+200°C						10	
range on request (*)						99	
<b>POWER SUPPLY</b>							
230 Vca ±10% 50/60 Hz							1
12 Vca ±10% 50/60 Hz							2
<b>OUTPUT</b>							
1 0-10 V e 1 relè SPDT 230 Vca 8 A							



# 3 Electromechanical thermostats

---

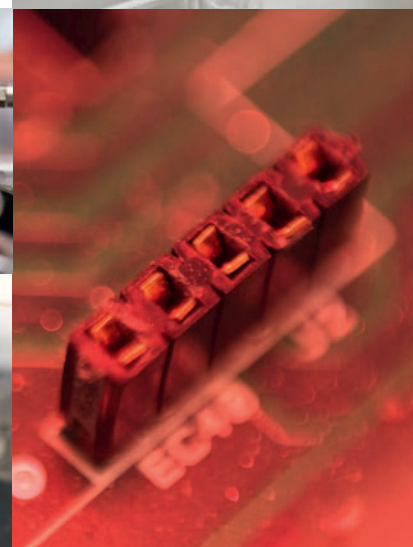



## ROOM THERMOSTAT

1-stage room thermostat. Models with on/off switch or summer/winter switch.



TA33/I

Technical data	
Sensor element	Gas-filled bellows with membrane
Hysteresis	1 K
Contact	NO/NC 250 V AC 16 (2,5) A
Temperature range	5...30 °C
Ambient temperature	Max. 50 °C
Ambient humidity	10...90 % RH (non-condensing)
Storage temperature	0...50 °C
Storage humidity	< 95 % RH
Mounting	Room
Casing	ABS, fireproof according UL94 V-0 color (Euro White)
Dimensions	80 x 80 x 44 mm
Weight	128 g
Protection class	IP20
Isolation class	I

Article	On/off button	Summer/winter switch	Hysteresis
TA31/I	-	-	1K
TA33/I	X	-	1K
TA34/I	-	X	1K

## ACCESSORIES

Article	Description
000071	Pin for knob lock - 2 pcs. per device

## ROOM THERMOSTATS WITH FIXED HYSTERESIS, IP 54

A wide range of low cost room thermostats for wall mounting.



ET060U



ET06060U

Technical data	
Sensor element	Liquid-filled coiled copper nickel bulb
Contacts	Microswitches with switching SPDT contacts (heat/cool)
Switch capacity	NC 16 (6) A, 250 V AC / NO 6 (4) A, 250 V AC
Temperature range	°C
Ambient temperature	-10...+65 °C
Ambient humidity	10...90% RH (without condensing)
Storage temperature	-20...+65 °C
Storage humidity	< 95 % RH
Max. bulb temperature	65 °C
Casing	Bayblend® base, ABS cover
Weight	1 stage: 1340 g 2 stage: 2520 g
Protection class	IP54
Isolation class	I
Dimensions	108 x 70 x 72 mm (132 x 88 x 70 mm for 2 stage models)

Article	Temperature range 1	Temperature range 2	Hysteresis range 1	Hysteresis range 2	Hidden setpoint
ET060	0...+60 °C		1.5±1 K		-
ET060U	0...+60 °C		1.5±1 K		X
ET06060	0...+60 °C	0...+60 °C	1.5±1 K	1.5±1 K	-
ET06060U	0...+60 °C	0...+60 °C	1.5±1 K	1.5±1 K	X



Note: range 2 always under the cover, range 1 under the cover

## WALL THERMOSTAT, IP65

High quality thermostats for use in cooling, heating and ventilation systems.

Technical data	
Sensor element	Liquid-filled coiled copper bulb
Contacts	Microswitches with SPDT contacts (heat/cool)
Switch capacity	15 (8) A, 24...250 V AC
Ambient temperature	-35...+60 °C °C
Ambient humidity	10...90 % RH (non-condensing)
Storage temperature	-40...+65 °C
Storage humidity	< 95 % RH
Max. bulb temperature	65 °C
Casing	Bayblend® base, ABS cover
Dimensions	108 x 70 x 72 mm
Weight	450 g
Protection class	IP65
Isolation class	I



DBET-26



DBET-26U

Article	Temperature range	Steps	Hysteresis	Step diff.	Hidden setpoint
DBET-22	-30...+30 °C	1	2...15 K	-	-
DBET-22U	-30...+30 °C	1	2...15 K	-	X
DBET-23	-30...+30 °C	1	1 K	-	-
DBET-22/2	-30...+30 °C	2	1 K	2...5 K	-
DBET-26	0...60 °C	1	2...15 K	-	-
DBET-27	0...60 °C	1	1 K	-	-
DBET-26U	0...60 °C	1	2...15 K	-	X
DBET-26/2	0...60 °C	2	1 K	2...5 K	-
DBET-22/2U	-30...+30 °C	2	1 K	2...5 K	X
DBET-23U	-30...+30 °C	1	1 K	-	X
DBET-26/2U	0...60 °C	2	1 K	2...5 K	X
DBET-27U	0...60 °C	1	1 K	-	X

## CAPILLARY THERMOSTATS, IP54

A wide range of low cost thermostats.



TC090

Technical data	
Sensor element	Liquid-filled coiled copper bulb with capillary PVC protected
Bulb	Ø 6.8 mm
Length, capillary tube	1.5 m
Contacts	Microswitches with SPDT contacts (heat/cool)
Switch capacity	NC 16 (4) A 250 V AC / NO 10 (6) A 250 V AC
Ambient temperature	-10...+65 °C
Ambient humidity	10...90% RH (non-condensing)
Storage temperature	-40...+70 °C
Storage humidity	< 95 % RH
Max. bulb temperature	130 °C
Casing	Bayblend® base, ABS cover
Weight	360 g
Protection class	IP54
Isolation class	I
Dimensions	108 x 70 x 72 mm

Article	Temperature range	Hysteresis
TC060	0...60 °C	4±1 K
TC090	0...90 °C	4±1 K

## ACCESSORIES

Article	Description
DBZ-30/14	Brass pocket 120 mm, ø external 8 mm, ø internal 7 mm, connection R 1/2"
DBZ-31/14	Stainless steel pocket AISI 304, 120 mm, ø external 9 mm, ø internal 7 mm, connection R 1/2"

## CAPILLARY THERMOSTAT, IP65

High quality thermostats for use in cooling, heating and ventilation systems.

Technical data	
Sensor element	Liquid-filled coiled copper bulb
Bulb	Ø 9.5 (Ø 8 for range 50...120°C)
Length, capillary tube	1.5 m
Contacts	Microswitches with SPDT contacts (heat/cool)
Switch capacity	15 (8) A, 24...250 V AC
Ambient temperature	-35...+65 °C
Ambient humidity	10...90 % RH (non-condensing)
Storage temperature	-40...+70 °C
Storage humidity	< 95 % RH
Casing	Bayblend® base, ABS cover
Dimensions	108 x 70 x 72 mm
Weight	400 g
Protection class	IP65
Isolation class	I



DBET-6



DBET-16U

Article	Temperature range	Steps	Hysteresis	Step diff.	Max. bulb temperature	Hidden setpoint	Immersion well to use
DBET-4	-30...+30 °C	1	2...20 K	-	60 °C	-	DBZ-01, DBZ-02
DBET-4U	-30...+30 °C	1	2...20 K	-	60 °C	X	DBZ-01, DBZ-02
DBET-4/2	-30...+30 °C	2	1 K	2...5 K	60 °C	-	DBZ-01, DBZ-02
DBET-5	-30...+30 °C	1	1 K	-	60 °C	-	DBZ-01, DBZ-02
DBET-6	-30...+30 °C	1	Minimum manual reset	-	60 °C	-	DBZ-01, DBZ-02
DBET-16	20...90 °C	1	2...20 K	-	100 °C	-	DBZ-01, DBZ-02
DBET-16U	20...90 °C	1	2...20 K	-	100 °C	X	DBZ-01, DBZ-02
DBET-17	20...90 °C	1	1 K	-	100 °C	-	DBZ-01, DBZ-02
DBET-18	20...90 °C	1	Maximum manual reset	-	100 °C	-	DBZ-01, DBZ-02
DBET-10	50...120 °C	1	2...20 K	-	150 °C	-	DBZ-17
DBET-5U	-30...+30 °C	1	1 K	-	60 °C	X	DBZ-01, DBZ-02
DBET-7	0...60 °C	1	2...20 K	-	75 °C	-	DBZ-01, DBZ-02
DBET-7/2	0...60 °C	2	1 K	2...5 K	75 °C	-	DBZ-01, DBZ-02
DBET-8	0...60 °C	1	1 K	-	75 °C	-	DBZ-01, DBZ-02
DBET-11	50...120 °C	1	1 K	-	150 °C	-	DBZ-17

## ACCESSORIES

Article	Description
DBZ-01	Brass pocket 120mm, Ø external 11 mm, Ø internal 10 mm, connection R 1/2"
DBZ-02	Stainless steel pocket AISI 304, 120 mm, Ø external 12 mm, Ø internal 10 mm, connection R 1/2"
DBZ-16	Brass pocket 120mm, Ø external 10 mm, Ø internal 8,5 mm, connection R 1/2"
DBZ-17	Stainless steel pocket AISI 304, 120 mm, Ø external 10mm, Ø internal 8,5 mm, connection R 1/2"

## DUCT THERMOSTAT, IP54

A range of high quality duct thermostats.



TZR6585

Technical data	
Sensor element	Liquid-filled coiled copper bulb with 200 mm protection spring and mounting bracket
Contacts	Microswitches with SPDT contacts (heat/cool)
Switch capacity	TZ090U: NC 16 (6) A, 250 V AC, NO 6 (4) A, 250 V AC / TZR6585: NC 16 (2,5) A, 250 V AC, NO 0,5 A, 250 V AC
Ambient temperature	-35...+65 °C
Ambient humidity	10...90% RH (non-condensing)
Insertion length	185 / Ø 21 mm
Storage temperature	-20...+70 °C
Storage humidity	< 95 % RH
Casing	Bayblend® base, ABS cover
Weight	590 g
Dimensions	108 x 70 x 72 mm
Protection class	IP54
Isolation class	I

Article	Temperature range	Hysteresis	Max. bulb temperature	Function	Hidden setpoint	Switch capacity
TZ090U	0...90 °C	4±1 K	120 °C	With SPDT contact	X	NC 16 (6) A, 250 V AC / NO 6 (4) A, 250 V AC
TZR6585	65...85 °C	20±5 K	125 °C	Manual maximum reset (unit can be reset only if temperature drops below the setpoint minus the hysteresis.)	-	NC 16 (2,5) A, 250 V AC / NO 0,5 A, 250 V AC

### ACCESSORIES

Article	Description
DBZ-25	Spiral protection bracket for capillary



*Note: the thermostats are supplied with spiral protection bracket model DBZ-25.*

*The device can only be rearmed if the temperature falls below the setpoint minus the hysteresis value.*

## DUCT THERMOSTAT, IP65

High quality thermostats for use in cooling, heating and ventilation systems.

Technical data	
Sensor element	Liquid-filled coiled copper bulb with 200 mm protection spring and mounting bracket
Contacts	Microswitches with SPDT contacts (heat/cool)
Switch capacity	15 (8) A, 24...250 V AC
Ambient temperature	-35...+65 °C
Ambient humidity	10...90 % RH (non-condensing)
Insertion length	200 / Ø 21 mm
Storage temperature	-40...+70 °C
Storage humidity	< 95 % RH
Casing	Bayblend® base, ABS cover
Weight	690
Dimensions	108 x 70 x 72 mm
Protection class	IP65
Isolation class	I



DBTZ-7



DBTZ-12U

Article	Temperature range	Steps	Hysteresis	Step diff.	Max. bulb temperature	Hidden setpoint
DBTZ-2U	-30...+30 °C	1	1 K	-	60 °C	X
DBTZ-7	0...60 °C	1	2...20 K	-	75 °C	-
DBTZ-7/2	0...60 °C	2	1 K	2...5 K	75 °C	-
DBTZ-8	0...60 °C	1	1 K	-	75 °C	-
DBTZ-12U	50...120 °C	1	Manual maximum reset	-	140 °C	X

### ACCESSORIES

Article	Description
DBZ-25	Spiral protection bracket for capillary



Note: the thermostats are supplied with spiral protection bracket model DBZ-25.



## ELECTROMECHANICAL CLAMP-ON THERMOSTAT, IP20

High quality thermostats for use in cooling, heating and ventilation systems.



Technical data	
Sensor element	Bimetal
Contacts	SPDT contacts
Switch capacity	NC 16 (2,5) A, 250 V AC / NO 2,5 A, 250 V AC
Ambient temperature	max 85 °C
Ambient humidity	10...90 % RH (non-condensing)
Storage temperature	-20...+60 °C
Storage humidity	< 95 % RH
Max. bulb temperature	90 °C
Casing	Zinc plated steel plate, not sealed ABS cover
Weight	150 g
Protection class	IP20
Dimensions	39 x 55 x 112 mm
Isolation class	I

Article	Temperature range	Hysteresis	Hidden setpoint
AT2090	+20...+90 °C	8±3 K	-
AT2090U	+20...+90 °C	8±3 K	X

## CLAMP-ON THERMOSTAT, IP65

Thermostats for use in cooling, heating and ventilation systems.



DBAT-5

Technical data	
Sensor element	Liquid-filled coiled copper bulb for contact
Contacts	Microswitches with SPDT contacts (heat/cool)
Switch capacity	15 (8) A, 24...250 V AC
Ambient temperature	-35...+65 °C
Ambient humidity	10...90 % RH (non-condensing)
Storage temperature	-40...+70 °C
Storage humidity	< 95 % RH
Hysteresis	2...20 K
Casing	Bayblend® base, ABS cover
Weight	410 g
Protection class	IP65 class I
Isolation class	I
Dimensions	108 x 70 x 72 mm



DBAT-5U

Article	Temperature range	Max. bulb temperature	Hidden setpoint
DBAT-3	0...60 °C	75 °C	-
DBAT-3U	0...60 °C	75 °C	X
DBAT-5	20...90 °C	95 °C	-
DBAT-5U	20...90 °C	95 °C	X

## FROST PROTECTION THERMOSTAT

High quality frost protection thermostats for use in cooling, heating and ventilation systems.

Technical data	
Sensor element	
Contacts	SPDT microswitch
Switch capacity	15 (8) A, 24...250 V AC
Accuracy	± 1K
Ambient temperature	Max. 55 °C
Ambient humidity	10...90 % RH (non-condensing)
Storage temperature	-30...+60 °C
Storage humidity	< 95 % RH
Max. bulb temperature	150 °C
Casing	Base in ABS, cover in transparent Polycarbonate (PC)
Weight	340 g
Protection class	IP65
Isolation class	I
Dimensions	140 x 62 x 65 mm (cable gland included)

Article	Temperature range	Hysteresis	Reset	Capillary length
TF18	-10...+10 °C or +14...+50 °F	2 K	Automatic	1.8 m
TF18R	-10...+10 °C or +14...+50 °F	Manual minimal reset	Manual	1.8 m
TF30	-10...+10 °C or +14...+50 °F	2 K	Automatic	3 m
TF30R	-10...+10 °C or +14...+50 °F	Manual minimal reset	Manual	3 m
TF60	-10...+10 °C or +14...+50 °F	2 K	Automatic	6 m
TF60R	-10...+10 °C or +14...+50 °F	Manual minimal reset	Manual	6 m
TF150	-10...+10 °C or +14...+50 °F	Manual minimal reset	Automatic	15 m
TF150R	-10...+10 °C or +14...+50 °F	Manual minimal reset	Manual	15 m

## ACCESSORIES

Article	Description
DBZ-01	Brass pocket 120mm, Ø external 11 mm, Ø internal 10 mm, connection R 1/2"
DBZ-02	Stainless steel pocket AISI 304, 120 mm, Ø external 12 mm, Ø internal 10 mm, connection R 1/2"



TF30



TF60R



TF18



DBZ-05

## IMMERSION THERMOSTATS, IP 54

Temperature control in pipes for heating, cooling and air conditioning systems, boilers and heaters. Temperature monitoring and safety protection with manual reset (2 stages).



TV090



TV09090U

Technical data	
Sensor element	Copper bulb with 120 mm brass pocket (on request with 200 mm length)
Contacts	Microswitches with SPDT contacts (heat/cool)
Switch capacity	With SPDT contact: NC 250 V AC 16 (6) A / NO 250 V AC 6 (4) manual maximum reset: NC 250 V AC 16 (2,5) A / NO 250 V AC 0,5 A
Ambient temperature	-35...+65 °C
Ambient humidity	10...90 % RH (non-condensing)
Storage temperature	-20...+70 °C
Storage humidity	< 95 % RH
Casing	Bayblend® base, ABS cover (2 stage models: sealed ABS)
Weight	single stage: 440 g double range: 560 g
Dimensions	108 x 70 x 72 mm (2 stage models: 132 x 88 x 70 mm)
Protection class	IP54
Isolation class	I

Article	Temperature range 1	Temperature range 2	Hysteresis range 1	Hysteresis range 2	Max. bulb temperature	Function	Hidden setpoint
TV090	0...90 °C	-	4 ± 1 K	-	120 °C	with SPDT contact	-
TV090U	0...90 °C	-	4 ± 1 K	-	120 °C	with SPDT contact	X
TVR6585	65...85 °C	-	20 ± 5 K	-	125 °C	manual maximum reset (unit can be reset only if temperature drops below the setpoint minus the hysteresis)	-
TVR90110	90...110 °C	-	20 ± 5 K	-	125 °C	Manual maximum reset (unit can be reset only if temperature drops below the setpoint minus the hysteresis)	-
TV09090U	0...90 °C	0...90 °C	4 ± 1 K	4 ± 1 K	120 °C	With SPDT contact	X
TV090UR85	0...90 °C	65...85 °C	4 ± 1 K	20 ± 5 K	120 °C	manual maximum reset with SPDT contact (unit can be reset only if temperature drops below the setpoint minus the hysteresis)	-

### ACCESSORIES

Article	Description
DBZ-30/14	Brass pocket 120 mm, Ø external 8 mm, Ø internal 7 mm, connection R 1/2"
DBZ-40/14	Brass pocket 108 mm, Ø external 16 mm, Ø internal 15 mm, connection R 1/2"
DBZ-31/14	Stainless steel pocket AISI 304, 120 mm, Ø external 9 mm, Ø internal 7 mm, connection R 1/2"
DBZ-41/14	Stainless steel pocket AISI 304, 120 mm, Ø external 16 mm, Ø internal 15 mm, connection R 1/2"



Note: the thermostats are supplied with standard pocket models DBZ-30/14 and DBZ-40/14.

## IMMERSION THERMOSTAT, IP65

High quality immersion thermostats for use in cooling, heating and ventilation systems.



DBTV-16

Technical data	
Sensor element	Liquid-filled coiled copper bulb
Contacts	Microswitches with SPDT contacts (heat/cool)
Switch capacity	15 (8) A, 24...250 V AC
Ambient temperature	-35...+65 °C
Ambient humidity	10...90 % RH (non-condensing)
Storage temperature	-40...+70 °C
Storage humidity	< 95 % RH
Casing	Bayblend® base, ABS cover
Weight	440 g
Dimensions	108 x 70 x 72 mm
Protection class	IP65
Isolation class	I

Article	Temperature range	Hysteresis	Max. bulb temperature	Hidden setpoint
DBTV-1	-30...+30 °C	2...20 K	60 °C	-
DBTV-2U	-30...+30 °C	1 K	60 °C	X
DBTV-7	0...+60 °C	2...20 K	75 °C	-
DBTV-7U	0...+60 °C	2...20 K	75 °C	X
DBTV-8	0...60 °C	1 K	75 °C	-
DBTV-8U	0...+60 °C	1 K	75 °C	X
DBTV-11	50...120 °C	1 K	140 °C	-
DBTV-16	+20...+90 °C	2...20 K	100 °C	-
DBTV-17	20...90 °C	1 K	100 °C	-
DBTV-17U	20...90 °C	1 K	100 °C	X
DBTV-18	20...90 °C	manual maximum reset	100 °C	-
DBTV-18U	20...90 °C	manual maximum reset	100 °C	X

### ACCESSORIES

Article	Description
DBZ-16/14	Brass pocket 120 mm, Ø external 10 mm, Ø internal 8,5 mm, connection R 1/2"
DBZ-17/14	Stainless steel pocket AISI 304, 120 mm, Ø external 10 mm, Ø internal 8,5 mm, connection R 1/2"



*Note: the thermostats are supplied with standard pocket model DBZ-16/14.*

*The device can only be reset if the temperature falls below the setpoint minus the hysteresis.*

## POCKETS FOR THERMOSTATS

Pockets for thermostats in brass or stainless steel.

Article	Tube length	Total length	Outside diameter tube	Internal diameter tube	Connection (diameter)	Material	Fixing stopper
DBZ-01	120 mm	140 mm	11 mm	10 mm	R1/2"	Brass / Cu Ni	X
DBZ-02	120 mm	148 mm	12 mm	10 mm	R1/2"	Stainless steel EN 1.4301	X
DBZ-16	120 mm	140 mm	10 mm	8.5 mm	R1/2"	Brass / Cu Ni	X
DBZ-16/14	120 mm	140 mm	10 mm	8.5 mm	R 1/2"	Brass / Cu Ni	-
DBZ-17	120 mm	148 mm	10 mm	8.5 mm	R1/2"	Stainless steel AISI 304	X
DBZ-17/14	120 mm	148 mm	10 mm	8.5 mm	R 1/2"	Stainless steel EN 1.4301	-
DBZ-17/14/200	200 mm	228 mm	10 mm	8,5 mm	R1/2"	Acciaio inox AISI 304	X
DBZ-18	40 mm	61 mm	11 mm	10 mm	R1/2"	Brass / Cu Ni	X
DBZ-19	40 mm	68 mm	10 mm	8.5 mm	R1/2"	Stainless steel AISI 304	X
DBZ-30/14	120 mm	140 mm	8 mm	7 mm	R1/2"	Brass / Cu Ni	X
DBZ-40/14	108 mm	128 mm	16 mm	15 mm	R1/2"	Brass / Cu Ni	X
DBZ-41/14	120 mm	148 mm	16 mm	14 mm	R1/2"	Stainless steel AISI 304	X



*For additional lengths of stainless steel versions contact Industrietechnik*



DBZ-01



DBZ-02



DBZ-16-14



DBZ-17-14



DBZ-18



DBZ-19



DBZ-30-14



DBZ-31-14



DBZ-40-14



DBZ-41-14

# 4 Electric heating controllers

---

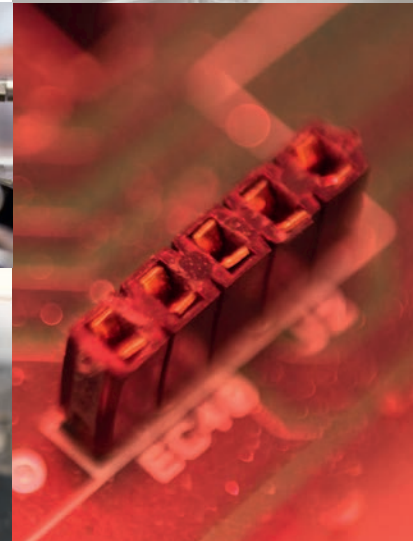
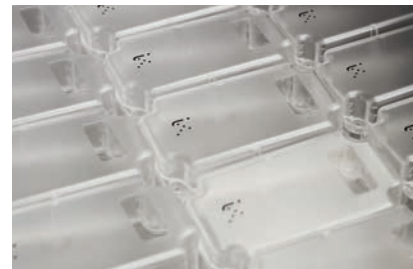



## CONTROLLERS WITH PI-CONTROL, 230...400 V AC, WALL MOUNTING

Wall mounted electric heating controller intended for control of radiators or electric heating coils. It is a complete controller with built-in sensor and setpoint adjustment. It pulses the whole load on/off and utilises time-proportional triac control. Both automatic control function adaptation, P- or PI-control and supply voltage adaptation, 230 V / 400 V.



CTR-M



CTR-D



CTR-ADD

Technical data	
Supply voltage	230...400 (210 - 415 V ~ 50/60 Hz 16 A)
Ambient temperature	0...30 °C
P-band	20 K (rapid temperature changes), 1.5 K (slow temperature changes)
I-time	6 min (rapid temperature changes)
Pulse period	60 s
Power dissipation	20 W of heat at full load
Dimensions	95 x 153 x 41 mm
Protection class	IP20

Inputs/outputs (I/Os)	
Setpoint range	0...30 °C (the external sensor determines the temperature range)
Night setback	0...10 K
Output load	Resistive load, max 16 A, min 1 A

Article	Description	Mounting
CTR-M	Electric heating controller with min./max. limitation	Wall
CTR/D	Electric heating controller	DIN-rail
CTR-ADD	Add-on unit	Wall
CTR-X/D	Electric heating controller for external 0...10 V DC control signal	DIN-rail

## ELECTRIC HEATING CONTROLLER FOR EXTERNAL INPUT SIGNAL 0-10 V, 230 V AC OR 400 V AC, WALL MOUNTING

Electric heating controller for controlling electric heating batteries, electric panels etc. It operates on an input signal from an external controller.



CTR230X010



CTR400X010

Technical data	
Supply voltage	...230X...: 230 V ~ (207...253 V ~ 50/60 Hz 16 A) ...400X...: 400 V ~ (360...440 V ~ 50/60 Hz 16 A)
Ambient temperature	0...30 °C , non-condensing
Pulse period	6/60/120 s , adjustable
Dimensions, external (WxHxD)	93 x 153 x 40 mm
Mounting	Wall
Protection class	IP20

Article	Description	Supply voltage
CTR230X010	Electric heating controller for external 0...10 V DC control signal	230 V AC
CTR400X010	Electric heating controller for external 0...10 V DC control signal	400 V AC

## ELECTRIC HEATING CONTROLLER FOR WALL MOUNTING, 3-PHASE, 210...415 V

The controller can be used with internal or external setpoint. Automatic control function adaptation, P- or PI-control. The controller can also be set to be controlled by an external 0...10 V DC signal.



CTR2000

Technical data	
Supply voltage	3-phase, 210...255 / 380...415 V AC, automatic adaptation
Setpoint	0...30 °C (the sensor determines the range)
Max. load	Max. 25 A, min. 3 A/phase
Sensor inputs	Two, main and min./max. limiting sensors (NTC sensor)
Control signal	0...10 V DC (external signal)
Mounting	Wall
Protection class	IP30
P-band	Supply air temperature control: 20 K, fixed Room temperature control: 1.5 K, fixed
I-time (supply air temperature control)	6 min, fixed
Pulse period	6...120 s
Dimensions	160 x 207 x 94 mm

Article	Description
CTR2000	Electric heating controller

4

## SLAVE BOARD FOR ELECTRIC HEATING CONTROLLERS

CTR-S1 is intended for use together with the electric heating controller CTR2000, in order to control extra loads.



CTR-S1

Article	Description
CTR-S1	Slave board for control of extra loads (+17 kW)

## ELECTRIC HEATING CONTROLLER FOR DIN-RAIL MOUNTING, 3-PHASE, 210...415 V, 25 A

For control of electric heating coils or radiators. The controllers pulse the whole load on/off and utilise time-proportional triac control. Automatic control function adaptation, P- or PI-control. The controllers can also be set to be controlled by an external 0...10 V DC signal.



CTR25

Technical data	
Supply voltage	3-phase, 210...255 / 380...415 V AC, automatic adaptation
Ambient temperature	0...40 °C
Mounting	DIN-rail
Dimensions (WxHxD)	195 x 200 x 95 mm
Protection class	IP20
P-band	Supply air temperature control: 20 K, fixed Room temperature control: 1.5 K, fixed
I-time	6 min, fixed
Pulse period	6...60
Load	25 A
Output	25 A, 3 x 400 V AC, 17 kW (3 x 230 V, 10 kW)
Inputs	
Setpoint	0...30 °C (the sensor determines the range)
Setpoint	0...30 °C (the sensor determines the range)
Setpoint	0...30 °C (the sensor determines the range)
Sensor inputs	Two, main and max./min. limiting sensors (NTC sensor). Note: Does not apply to TTC25X.
Sensor inputs	Two, main and max./min. limiting sensors (NTC sensor). Note: Does not apply to TTC25X.
Sensor inputs	Two, main and max./min. limiting sensors (NTC sensor). Note: Does not apply to TTC25X.
Control signal	0...10 V DC

Article	For use with Regin NTC sensor	For external 0...10 V DC control signal only	External 0...10 V DC control signal option
CTR25	X	-	X



To control larger electrical loads, see the step controllers SC4 and SC6.

## ELECTRIC HEATING CONTROLLER FOR DIN-RAIL MOUNTING, 3-PHASE, 210...415 V, 40 A

For control of electric heating coils or radiators. The controllers pulse the whole load on/off and utilise time-proportional triac control. Automatic control function adaptation, P- or PI-control. The controllers can also be set to be controlled by an external 0...10 V DC signal.



CTR40

Technical data	
Supply voltage	3-phase, 210...255 / 380...415 V AC, automatic adaptation
Ambient temperature	0...40 °C
Mounting	DIN-rail
Dimensions (WxHxD)	195 x 220 x 95 mm
Protection class	IP20
P-band	Supply air temperature control: 20 K, fixed Room temperature control: 1.5 K, fixed
I-time	6 min, fixed
Pulse period	6...60 s
Load	40 A
Output	40 A, 3 x 400 V AC, 27 kW (3 x 230 V, 16 kW)
Inputs	
Setpoint	0...30 °C (the sensor determines the range)
Sensor inputs	Two, main and max./min. limiting sensors (NTC sensor).
Control signal	0...10 V DC

Article	Description	External 0...10 V DC control signal option
CTR40	Electric heating controller with temperature control	X



To control larger electrical loads, see the step controllers SC4 and SC6.

## ELECTRIC HEATING CONTROLLER FOR DIN-RAIL MOUNTING, 3-PHASE, 400 V, 80 A

For control of electric heating coils or radiators. The controllers pulse the whole load on/off and utilise time-proportional triac control. Automatic control function adaptation, P- or PI-control. The controllers can also be set to be controlled by an external 0...10 V DC signal.



CTR80

Technical data	
Supply voltage	3-phase, 400 V AC ±10%
Ambient temperature	0...40 °C
Mounting	DIN-rail
Dimensions (WxHxD)	195 x 220 x 105 mm
Protection class	IP20
P-band	Supply air temperature control: 20 K, fixed Room temperature control: 1.5 K, fixed
I-time	6 min, fixed
Pulse period	6...120 s
Load	80 A
Output	80 A, 3 x 400 V AC, 55 kW
Inputs	
Setpoint	0...30 °C (the sensor determines the range)
Sensor inputs	Two, main and max./min. limiting sensors (NTC sensor).
Control signal	0...10 V DC

Article	Description	External 0...10 V DC control signal option
CTR80	Electric heating controller with temperature control	X



To control larger electrical loads, see the step controllers SC4 and SC6.



# 5 Sensors, transmitters and switches

---

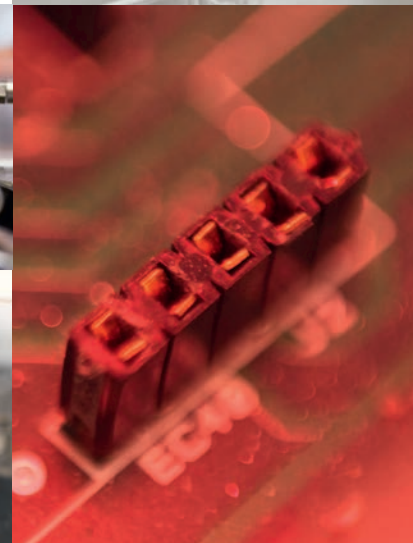
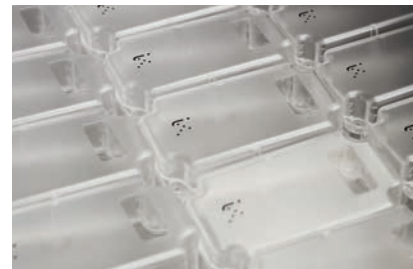



# Temperature transmitters and sensors

## CLAMP-ON SENSOR WITH HOUSING

Clamp-on sensor for surface temperature measurement.



SC

Technical data	
Protection class	IP65
Time constant	3 s
Measuring range, temperature	-20...+120 °C
Cable gland	M16
Dimensions, external (WxHxD)	104 x 78 x 51 mm
Accessories, included	Two metal straps and heat-conductive paste (art.nr: PASTA-20).
Material	
Material, housing	Polycarbonate (PC)
Material, base	Polycarbonate (PC)

Article	Sensor element	Nominal resistance	Equivalent
SC-PT100-Y	PT100	100 Ω (0°C)	-
SC-PT1000-Y	PT1000	1000 Ω (0°C)	-
SC-NTC1.8-Y	NTC 1.8	1800 Ω (25°C)	TAC
SC-NTC2.2-Y	NTC 2.2	2252 Ω (25°C)	Johnson Controls
SC-NTC10-02-Y	NTC 10	10 kΩ (25°C)	Carel - Evco - Eliwell - AB Industrietechnik
SC-NTC10-03-Y	NTC 10	10 kΩ (25°C)	Andover - Delta Controls - Siebe - York
SC-NTC20-Y	NTC 20	20 kΩ (25°C)	Honeywell
SC-NI1000-01-Y	Ni1000	1000 Ω (0°C)	Siemens - Landis & Staefa
SC-NI1000-02-Y	Ni1000	1000 Ω (0°C)	Sauter

## ACCESSORIES

Article	Description
PASTA-20	Heat-conductive paste in tube, 20 g

## CLAMP-ON SENSOR WITH CABLE

For surface temperature measurement. Including clamp (Ø max 40 mm).

Technical data	
Material	Nickel-plated copper
Cable length	1.5 m
Protection class	IP65
Dimensions	36 x 10.5 x 7.5 / models with PVC sleeve: 23.5 x 6 x 9.5 mm

Article	Sensor element	Nominal resistance	Temperature range	Equivalent
SCC-PT100	PT100	100 Ω (0°C)	-30...+150 °C	-
SCC-PT1000	PT1000	1000 Ω (0°C)	-30...+150 °C	-
SCC-NTC1.8	NTC 1.8	1800 Ω (25°C)	-30...+120 °C	TAC
SCC-NTC2.2	NTC 2.2	2252 Ω (25°C)	-30...+150 °C	Johnson Controls
SCC-NTC10-01	NTC 10	10 kΩ (25°C)	-30...+150 °C	Aquatrol - Johnson Controls - Satchwell - Trend - Cylon - Honeywell - Distech
SCC-NTC10-02	NTC 10	10 kΩ (25°C)	-30...+110 °C	Carel - Evco - Eliwell - AB Industrietechnik
SCC-NTC10-02-BR-J	NTC 10	10 kΩ (25°C)	-50...+110 °C	Carel - Evco - Eliwell - AB Industrietechnik
SCC-NTC10-03	NTC 10	10 kΩ (25°C)	-30...+150 °C	Andover - Delta Controls - Siebe - York
SCC-NTC15-01	NTC 15	15 kΩ (0°C)		Regin - AB Industrietechnik
SCC-NTC20	NTC 20	20 kΩ (25°C)	-30...+150 °C	Honeywell
SCC-NI1000-01	Ni1000	1000 Ω (0°C)	-30...+150 °C	Siemens - Landis & Staefa
SCC-NI1000-02	Ni1000	1000 Ω (0°C)	-30...+150 °C	Sauter



SCC



SCC-NTC10-02-BR-J



SCC-NTC15-01

### ACCESSORIES

Article	Description
PASTA-20	Heat-conductive paste in tube, 20 g

## DUCT SENSOR WITH HOUSING

Duct sensor for air temperature measurement in ventilation ducts.



STC

### Technical data

Protection class	IP65
Cable gland	M16
Diameter, probe	8 mm
Dimensions, external (WxHxD)	78 x 263 x 104 mm
Time constant	16 s
Measuring range, temperature	-30...+70 °C

### Material

Material, housing	Polycarbonate (PC)
Material, base	Polycarbonate (PC)
Material, probe	Stainless steel, SUS304

### MODELS

Article	Sensor element	Nominal resistance	Insertion length	Equivalent
STC-PT100-Y	PT100	100 Ω (0°C)	60...205 mm	-
STC-PT1000-Y	PT1000	1000 Ω (0°C)	60...205 mm	-
STC-PT1000/430-Y	PT1000	1000 Ω (0°C)	60...405 mm	-
STC-NTC1.8-Y	NTC 1.8	1800 Ω (25°C)	60...205 mm	TAC
STC-NTC2.2-Y	NTC 2.2	2252 Ω (25°C)	60...205 mm	Johnson Controls
STC-NTC10-01-Y	NTC 10	10 kΩ (25°C)	60...205 mm	Aquatrol - Johnson Controls - Satchwell - Trend - Cylon - Honeywell - Distech
STC-NTC10-02-Y	NTC 10	10 kΩ (25°C)	60...205 mm	Carel - Evco - Eliwell - AB Industrietechnik
STC-NTC10-03-Y	NTC 10	10 kΩ (25°C)	60...205 mm	Andover - Delta Controls - Siebe - York
STC-NTC20-Y	NTC 20	20 kΩ (25°C)	60...205 mm	Honeywell
STC-NI1000-01-Y	Ni1000	1000 Ω (0°C)	60...205 mm	Siemens - Landis & Staefa
STC-NI1000-02-Y	Ni1000	1000 Ω (0°C)	60...205 mm	Sauter

## DUCT SENSOR WITH CABLE

Duct sensor for air temperature measurement in ventilation ducts. Adjustable insertion length.



STCC

Technical data	
Cable length	1.5 m
Insertion length	15...145 mm adjustable
Diameter	9 mm
Protection class	IP20

Article	Sensor element	Nominal resistance	Temperature range	Equivalent
STCC-PT100	PT100	100 Ω (0°C)	-30...+70 °C	-
STCC-PT1000	PT1000	1000 Ω (0°C)	-30...+70 °C	-
STCC-NTC1.8	NTC 1.8	1800 Ω (25°C)	-30...+70 °C	TAC
STCC-NTC2.2	NTC 2.2	2252 Ω (25°C)	-30...+70 °C	Johnson Controls
STCC-NTC10-01	NTC 10	10 kΩ (25°C)	-30...+70 °C	Aquatrol - Johnson Controls - Satchwell - Trend - Cylon - Honeywell - Distech
STCC-NTC10-02	NTC 10	10 kΩ (25°C)	-30...+70 °C	Carel - Evco - Eliwell - AB Industrietechnik
STCC-NTC10-03	NTC 10	10 kΩ (25°C)	-30...+70 °C	Andover - Delta Controls - Siebe - York
STCC-NTC15-01	NTC 15	15 kΩ (0°C)	0...30 °C	Regin - AB Industrietechnik
STCC-NTC15-02	NTC 15	15 kΩ (0°C)	0...60 °C	Regin - AB Industrietechnik
STCC-NTC15-03	NTC 15	15 kΩ (20°C)	20...50 °C	Regin - AB Industrietechnik
STCC-NTC15-04	NTC 15	15 kΩ (0°C)	0...40 °C	Regin - AB Industrietechnik
STCC-NTC20	NTC 20	20 kΩ (25°C)	-30...+70 °C	Honeywell
STCC-NI1000-01	Ni1000	1000 Ω (0°C)	-30...+70 °C	Siemens - Landis & Staefa
STCC-NI1000-02	Ni1000	1000 Ω (0°C)	-30...+70 °C	Sauter

5

## DUCT SENSOR WITH HOUSING FOR AVERAGE TEMPERATURE MEASUREMENT

Sensor with a 4-point average temperature measurement for duct mounting.



STM

Technical data	
Protection class	IP65
Time constant	63 s at 2 m/s and 43 s at 5 m/s
Insertion length	75 mm
Measuring range, temperature	-20...+70 °C
Cable gland	M16
Diameter, probe	mm
Dimensions, external (WxHxD)	78 x 132 x 104 mm
Sensor cable length	3 m
Material	
Material, housing	Polycarbonate (PC)
Material, base	Polycarbonate (PC)
Material, probe	Stainless steel, SUS304

### MODELS

Article	Sensor element	Nominal resistance	Equivalent
STM-PT1000-Y	PT1000 (DIN class B)	1000 Ω (0°C)	-

## IMMERSION SENSOR WITH HOUSING, WITHOUT WELL, R1/4"

Immersion sensor for temperature measurement of heating or cooling batteries in ventilation units. Probe in stainless steel without a well.



SI

### Technical data

Protection class	IP65
Time constant	4 s
Insertion length	90 mm
Measuring range, temperature	-20...+120 °C
Cable gland	M16
Connection, without well	R1/4"
Diameter, probe	5 mm
Pressure rating	PN16
Dimensions, external (WxHxD)	78 x 158 x 104 mm

### Material

Material, housing	Polycarbonate (PC)
Material, base	Polycarbonate (PC)
Material, probe	Stainless steel, SUS304

Article	Sensor element	Nominal resistance	Equivalent
SI-PT100-Y	PT100	100 Ω (0°C)	-
SI-PT1000-Y	PT1000	1000 Ω (0°C)	-
SI-NTC1.8-Y	NTC 1.8	1800 Ω (25°C)	TAC
SI-NTC2.2-Y	NTC 2.2	2252 Ω (25°C)	Johnson Controls
SI-NTC10-01-Y	NTC 10	10 kΩ (25°C)	Aquatrol - Johnson Controls - Satchwell - Trend - Cylon - Honeywell - Distech
SI-NTC10-02-Y	NTC 10	10 kΩ (25°C)	Carel - Evco - Eliwell - AB Industrietechnik
SI-NTC10-03-Y	NTC 10	10 kΩ (25°C)	Andover - Delta Controls - Siebe - York
SI-NTC20-Y	NTC 20	20 kΩ (25°C)	Honeywell
SI-NI1000-01-Y	Ni1000	1000 Ω (0°C)	Siemens - Landis & Staefa
SI-NI1000-02-Y	Ni1000	1000 Ω (0°C)	Sauter

## IMMERSION SENSOR WITH HOUSING AND WELL

Immersion sensor for temperature measurement in heating- or cooling applications. Supplied with a stainless steel well. Available in different lengths.



STI

### Technical data

Protection class	IP65
Time constant	18 s
Measuring range, temperature	-20...+120 °C
Cable gland	M16
Connection, well	R1/2"
Diameter, well	7 mm
Pressure rating	PN25
Dimensions, external (WxHxD)	78 x 156 x 104 mm

### Material

Material, housing	Polycarbonate (PC)
Material, base	Polycarbonate (PC)
Material, probe	Stainless steel, SUS304
Material, well	Nickel-plated copper

## MODELS

Article	Sensor element	Nominal resistance	Insertion length	Equivalent
STI-PT100-Y	PT100	100 Ω (0°C)	90 mm	-
STI-PT1000-Y	PT1000	1000 Ω (0°C)	90 mm	-
STI-NTC1.8-Y	NTC 1.8	1800 Ω (25°C)	90 mm	TAC
STI-NTC2.2-Y	NTC 2.2	2252 Ω (25°C)	90 mm	Johnson Controls
STI-NTC10-01-Y	NTC 10	10 kΩ (25°C)	90 mm	Aquatrol - Johnson Controls - Satchwell - Trend - Cylon - Honeywell - Distech
STI-NTC10-02-Y	NTC 10	10 kΩ (25°C)	90 mm	Carel - Evco - Eliwell - AB Industrietechnik
STI-NTC10-03-Y	NTC 10	10 kΩ (25°C)	90 mm	Andover - Delta Controls - Siebe - York
STI-NTC20-Y	NTC 20	20 kΩ (25°C)	90 mm	Honeywell
STI-NI1000-01-Y	Ni1000	1000 Ω (0°C)	90 mm	Siemens - Landis & Staefa
STI-NI1000-02-Y	Ni1000	1000 Ω (0°C)	90 mm	Sauter

## ACCESSORIES

Article	Insertion length	Material	Description
DBZ-90WN	90 mm	Nickel-plated copper	Well for probe STI



*Insertion length 50/120/170/310 are available upon request, please contact Industrietechnik for more information.*

*Stainless steel SUS304 available upon request, please contact Industrietechnik for more information.*



DBZ-90WN

## IMMERSION SENSOR WITH DIN HEAD

Immersion sensor for industrial applications.

Technical data	
Pressure rating	PN6
Material, well	Stainless steel AISI 304
Diameter, well	6 mm
Insertion length	200 mm
Dimensions	Max. Ø 82 x h 307 mm
Protection class	IP54
Precision	Class B

Article	Sensor element	Nominal resistance	Temperature range
DPTD-PT100	PT100	100 Ω (0°C)	-50...+600 °C
DPTD-PT1000	PT1000	1000 Ω (0°C)	-50...+600 °C



DPTD



## IMMERSION SENSOR WITH FIXED CABLE

Immersion sensor for water temperature measurement with threaded connection R1/4".



STIC

Technical data	
Temperature range	-30...+70 °C
Cable length	1.5 m
Connection	R1/4"
Diameter	4 mm
Material, probe	Stainless steel, SUS304
Pressure rating	PN10
Protection class	IP65

Article	Sensor element	Nominal resistance	Insertion length	Equivalent
STIC-PT100/135	PT100	100 Ω (0°C)	135 mm	-
STIC-PT1000/135	PT1000	1000 Ω (0°C)	135 mm	-
STIC-NTC1.8/135	NTC 1.8	1800 Ω (25°C)	135 mm	TAC
STIC-NTC2.2/135	NTC 2.2	2252 Ω (25°C)	135 mm	Johnson Controls
STIC-NTC10-01/135	NTC 10	10 kΩ (25°C)	135 mm	Aquatrol - Johnson Controls - Satchwell - Trend - Cylon - Honeywell - Distech
STIC-NTC10-02/135	NTC 10	10 kΩ (25°C)	135 mm	Carel - Evco - Eliwell - AB Industrietechnik
STIC-NTC10-03/135	NTC 10	10 kΩ (25°C)	135 mm	Andover - Delta Controls - Siebe - York
STIC-NTC20/135	NTC 20	20 kΩ (25°C)	135 mm	Honeywell
STIC-NI1000-01/135	Ni1000	1000 Ω (0°C)	135 mm	Siemens - Landis & Staefa
STIC-NI1000-02/135	Ni1000	1000 Ω (0°C)	135 mm	Sauter

Article	Sensor element	Nominal resistance	Insertion length	Equivalent
STIC-PT100/220	PT100	100 Ω (0°C)	220 mm	-
STIC-PT1000/220	PT1000	1000 Ω (0°C)	220 mm	-
STIC-NTC1.8/220	NTC 1.8	1800 Ω (25°C)	220 mm	TAC
STIC-NTC2.2/220	NTC 2.2	2252 Ω (25°C)	220 mm	Johnson Controls
STIC-NTC10-01/220	NTC 10	10kΩ (25°C)	220 mm	Aquatrol - Johnson Controls - Satchwell - Trend - Cylon - Honeywell
STIC-NTC10-02/220	NTC 10	10kΩ (25°C)	220 mm	Carel - Evco - Eliwell - AB Industrietechnik
STIC-NTC10-03/220	NTC 10	10kΩ (25°C)	220 mm	Andover - Delta Controls - Siebe - York
STIC-NTC20/220	NTC 20	20kΩ (25°C)	220 mm	Honeywell
STIC-NI1000-01/220	Ni1000	1000 Ω (0°C)	220 mm	Siemens - Landis & Staefa
STIC-NI1000-02/220	Ni1000	1000 Ω (0°C)	220 mm	Sauter

Article	Sensor element	Nominal resistance	Insertion length	Equivalent
STIC-PT100/300	PT100	100 Ω (0°C)	300 mm	-
STIC-PT1000/300	PT1000	1000 Ω (0°C)	300 mm	-
STIC-NTC1.8/300	NTC 1.8	1800 Ω (25°C)	Max. 300 mm	TAC
STIC-NTC2.2/300	NTC 2.2	2252 Ω (25°C)	300 mm	Johnson Controls
STIC-NTC10-01/300	NTC 10	10 kΩ (25°C)	300 mm	Aquatrol - Johnson Controls - Satchwell - Trend - Cylon - Honeywell - Distech
STIC-NTC10-02/300	NTC 10	10 kΩ (25°C)	300 mm	Carel - Evco - Eliwell - AB Industrietechnik
STIC-NTC10-03/300	NTC 10	10 kΩ (25°C)	300 mm	Andover - Delta Controls - Siebe - York
STIC-NTC20/300	NTC 20	20 kΩ (25°C)	300 mm	Honeywell
STIC-NI1000-01/300	Ni1000	1000 Ω (0°C)	300 mm	Siemens - Landis & Staefa
STIC-NI1000-02/300	Ni1000	1000 Ω (0°C)	300 mm	Sauter

## ACCESSORIES

Article	Description
DF	Mounting flange for 135 mm long sensors for mounting in ventilation ducts



DF

## WELL

Well for immersion sensors.

Technical data	
Connection	R1/2"
Pressure rating	PN25
Material	Stainless steel AISI 316

Article	Insertion length	Description
DBZ-90R	90 mm	Well for probe SI...
DBZ-135R	135 mm	Well for probe STIC-.../135
DBZ-220R	220 mm	Well for probe STI-.../220
DBZ-300R	300 mm	Well for probe STI-.../300



DBZ-90WN



DBZ-135R

## ACCESSORIES

Article	Description
DBZ-AD1	Adapter 1/4" to 1/2". For mounting immersion sensors in 1/2".



DBZ-AD1

## ROOM SENSOR

For room temperature measurement.

Technical data	
Temperature range	0...50 °C
Dimensions	86 x 86 x 30 mm
Protection class	IP30



SA

Article	Sensor element	Nominal resistance	Temperature range	Equivalent
SA-PT100	PT100	100 Ω (0°C)	0...50 °C	-
SA-PT1000	PT1000	1000 Ω (0°C)	0...50 °C	-
SA-NTC1.8	NTC 1.8	1800 Ω (25°C)	0...50 °C	TAC
SA-NTC2.2	NTC 2.2	2252 Ω (25°C)	0...50 °C	Johnson Controls
SA-NTC10-01	NTC 10	10 kΩ (25°C)	0...50 °C	Aquatrol - Johnson Controls - Satchwell - Trend - Cylon - Honeywell - Distech
SA-NTC10-02	NTC 10	10 kΩ (25°C)	0...50 °C	Carel - Evco - Eliwell - AB Industrietechnik
SA-NTC10-03	NTC 10	10 kΩ (25°C)	0...50 °C	Andover - Delta Controls - Siebe - York
SA-NTC15-01	NTC 15	15 kΩ (0°C)	0...30 °C	Regin - AB Industrietechnik
SA-NTC15-03	NTC 15	15 kΩ (20°C)	20...50 °C	Regin - AB Industrietechnik
SA-NTC15-04	NTC 15	15 kΩ (0°C)	0...40 °C	Regin - AB Industrietechnik
SA-NTC20	NTC 20	20 kΩ (25°C)	0...50 °C	Honeywell
SA-NI1000-01	Ni1000	1000 Ω (0°C)	0...50 °C	Siemens - Landis & Staefa
SA-NI1000-02	Ni1000	1000 Ω (0°C)	0...50 °C	Sauter

## ROOM SENSOR WITH SETPOINT ADJUSTMENT

For room temperature measurement. Can also be used solely for setpoint adjustment.



SAP

### Technical data

Dimensions 86 x 86 x 30 mm

Protection class IP30

Article	Sensor element	Nominal resistance	Potentiometer range	Temperature range	Equivalent
SAP-PT100-2	PT100	100 Ω (0°C)	5...30 °C 0...10 kΩ	0...50 °C	-
SAP-PT1000-1	PT1000	1000 Ω (0°C)	5...31 °C 1020...1120 Ω	0...50 °C	-
SAP-PT1000-2	PT1000	1000 Ω (0°C)	5...30 °C 0...10 kΩ	0...50 °C	-
SAP-NTC1.8-2	NTC 1.8	1800 Ω (25°C)	5...30 °C 0...10 kΩ	0...50 °C	TAC
SAP-NTC2.2-2	NTC 2.2	2252 Ω (25°C)	5...30 °C 0...10 kΩ	0...50 °C	
SAP-NTC10-02-2	NTC 10	10 kΩ (25°C)	5...30 °C 0...10 kΩ	0...50 °C	Carel - Evco - Eliwell - AB Industrietechnik
SAP-NTC10-03-2	NTC 10	10 kΩ (25°C)	5...30 °C 0...10 kΩ	0...50 °C	Andover - Delta Controls - Siebe - York
SAP-NTC15-01-3	NTC 15	15 kΩ (0°C)	0...30 °C 0...5 kΩ	0...30 °C	Regin - AB Industrietechnik
SAP-NTC20-2	NTC 20	20 kΩ (25°C)	5...30 °C 0...10 kΩ	0...50 °C	Honeywell
SAP-NI1000-01-2	Ni1000	1000 Ω (0°C)	5...30 °C 0...10 kΩ	0...50 °C	Siemens - Landis & Staefa
SAP-NI1000-02-2	Ni1000	1000 Ω (0°C)	5...30 °C 0...10 kΩ	0...50 °C	Sauter

## OUTDOOR TEMPERATURE SENSOR WITH HOUSING

Outdoor sensor for air temperature measurement.



SE

### Technical data

Protection class IP65

Measuring range, temperature -50...+70 °C

Cable gland M16

Dimensions, external (WxHxD) 78 x 51 x 104 mm

### Material

Material, housing Polycarbonate (PC)

Material, base Polycarbonate (PC)

### MODELS

Article	Sensor element	Nominal resistance	Equivalent
SE-PT100-Y	PT100	100 Ω (0°C)	-
SE-PT1000-Y	PT1000	1000 Ω (0°C)	-
SE-NTC1.8-Y	NTC 1.8	1800 Ω (25°C)	TAC
SE-NTC2.2-Y	NTC 2.2	2252 Ω (25°C)	Johnson Controls
SE-NTC10-01-Y	NTC 10	10 kΩ (25°C)	Aquatrol - Johnson Controls - Satchwell - Trend - Cylon - Honeywell - Distech
SE-NTC10-02-Y	NTC 10	10 kΩ (25°C)	Carel - Evco - Eliwell - AB Industrietechnik
SE-NTC10-03-Y	NTC 10	10 kΩ (25°C)	Andover - Delta Controls - Siebe - York
SE-NTC20-Y	NTC 20	20 kΩ (25°C)	Honeywell
SE-NI1000-01-Y	Ni1000	1000 Ω (0°C)	Siemens - Landis & Staefa
SE-NI1000-02-Y	Ni1000	1000 Ω (0°C)	Siemens - Landis & Staefa

## CABLE TEMPERATURE SENSOR, METAL BULB



NT04

Technical data	
Material, bulb	Stainless steel AISI 304
Material, cable	Thermoplastic rubber
Bulb length	40 mm
Cable length	2 m
Diameter	4 mm
Protection class	IP67

Article	Sensor element	Nominal resistance	Temperature range	Compatible with
NT0420-NTC1.8	NTC 1.8	1800 Ω (25°C)	-50...+110 °C	Tac
NT0420-NTC2.2	NTC 2.2	2252 Ω (25°C)	-50...+110 °C	Johnson Controls
NT0420-NTC10-01	NTC 10	10 kΩ (25°C)	-50...+110 °C	Aquatrol - Johnson Controls - Satchwell - Trend - Cylon - Honeywell
NT0420-NTC10-02	NTC 10	10 kΩ (25°C)	-50...+110 °C	Carel - Evco - Eliwell - AB Industrietechnik
NT0420-NTC10-03	NTC 10	10 kΩ (25°C)	-50...+110 °C	Andover - Delta Controls - Siebe - York
NT0420-NTC20	NTC 20	20 kΩ (25°C)	-50...+110 °C	Honeywell
NT0420-NI1000-01	Ni1000	1000 Ω (0°C)	-50...+110 °C	Siemens - Landis & Staefa
NT0420-NI1000-02	Ni1000	1000 Ω (0°C)	-50...+110 °C	Sauter

## CABLE TEMPERATURE SENSOR, PVC BULB



NT02

Technical data	
Material, bulb	PP
Material, cable	PVC
Bulb length	23 mm
Cable length	2 m
Diameter	6 mm
Protection class	IP67

Article	Sensor element	Nominal resistance	Temperature range	Equivalent
NT0220-NTC1.8	NTC 1.8	1800 Ω (25°C)	-40...+80 °C	Tac
NT0220-NTC2.2	NTC 2.2	2252 Ω (25°C)	-40...+80 °C	Johnson Controls
NT0220-NTC10-01	NTC 10	10 kΩ (25°C)	-40...+80 °C	Aquatrol - Johnson Controls - Satchwell - Trend - Cylon - Honeywell - Distech
NT0220-NTC10-02	NTC 10	10 kΩ (25°C)	-40...+80 °C	Carel - Evco - Eliwell - AB Industrietechnik
NT0220-NTC10-03	NTC 10	10 kΩ (25°C)	-40...+80 °C	Andover - Delta Controls - Siebe - York
NT0220-NTC20	NTC 20	20 kΩ (25°C)	-40...+80 °C	Honeywell
NT0220-NTC100	NTC 100	100 kΩ (25°C)	-40...+80 °C	Industrietechnik
NT0220-NI1000-01	Ni1000	1000 Ω (0°C)	-40...+80 °C	Siemens - Landis & Staefa
NT0220-NI1000-02	Ni1000	1000 Ω (0°C)	-40...+80 °C	Sauter

## CABLE TEMPERATURE SENSOR, NTC, FOR USE WITH THE TTC SERIES



NT05

Technical data	
Sensor element	NTC, 15...10 kΩ
Material, tube	Nickel plated brass
Material, cable	Silicone
Bulb length	50 mm
Cable length	1.5 m
Diameter	6 mm
Protection class	IP65

Article	Sensor element	Nominal resistance	Temperature range	Compatible with
NT0515-NTC15	NTC 15	15 kΩ (0°C)	0...30 °C	Regin

### ACCESSORIES

Article	Description
PASTA-20	Heat-conductive paste in tube, 20 g



*This sensor cannot be used together with the CTR series.*

## CABLE TEMPERATURE SENSOR, METAL BULB, PT100/PT1000

Universal sensor.



PT04

Technical data	
Material, bulb	Stainless steel AISI 304
Material, cable	Thermoplastic rubber
Bulb length	40 mm
Cable length	1.5 m
Diameter	4 mm
Protection class	IP67
Accuracy	class B

Article	Sensor element	Nominal resistance	Temperature range	Compatible with
PT0415-PT100	PT100	100 Ω (0°C)	-30...+110 °C	Universal
PT0415-PT1000	PT1000	1000 Ω (0°C)	-30...+110 °C	Universal

## CABLE TEMPERATURE SENSOR -50...+200 °C, METAL BULB



PT10

Technical data	
Material, bulb	Stainless steel AISI 304
Material, cable	Silicone
Bulb length	100 mm
Cable length	2 m (3 wires)
Diameter	6 mm
Protection class	IP67
Precision	Class B

Article	Sensor element	Nominal resistance	Temperature range	Compatible with
PT1020-PT100	PT100	100 Ω (0°C)	-50...+200 °C	Universal
PT1020-PT1000	PT1000	1000 Ω (0°C)	-50...+200 °C	Universal

## CABLE TEMPERATURE SENSOR -50...350 °C, METAL BULB

Special cable sensor for high temperature.

Technical data	
Material, bulb	Stainless steel AISI 304 with ceramic insert
Material, cable	Fiberglass
Bulb length	100 mm
Cable length	2 m (3 wires)
Diameter	6 mm
Protection class	IP44
Precision	Class B

Article	Sensor element	Nominal resistance	Temperature range	Compatible with
PT1020C-PT100	PT100	100 Ω (0°C)	-50...+350 °C	Universal
PT1020C-PT1000	PT1000	1000 Ω (0°C)	-50...+350 °C	Universal



PT10xxC

## SETPOINT DEVICE FOR PT1000

Setpoint device which gives resistance corresponding to the standard PT1000 table.

Technical data	
Temperature range	5...30 °C
Mounting	Panel mounting
Dimensions	60 x 60 x 38 mm
Protection class	IP20

Article	Description
SET-PT1000	Setpoint device
SET-30	Setpoint device for electric heating controllers CTR



SET-PT1000

## HEAT-CONDUCTIVE PASTE

Article	Description
PASTA-20	Heat-conductive paste in tube, 20 g



PASTA-20



## SENSOR CHARACTERISTICS

Equivalent	PT100	PT1000	NTC 1,8K	NTC 2,2K	NTC 10K-01	NTC 10K-02	NTC 10K-03	NTC 15K-01	NTC 15K-02	NTC 15K-03	NTC 15K-04	NTC 20K	NI 1000-01	NI 1000-02
Temp. °C	Ω	Ω	Ω	Ω	Ω	Ω	Ω	Ω	Ω	Ω	Ω	Ω	Ω	Ω
150	157,3	1573			186									
140	153,6	1536			235								1737	1909
130	149,8	1498			301								1675	1833
120	146,1	1461			390								1615	1760
110	142,3	1423	138	115	511	758	624					818	1557	1688
100	138,5	1385	177	153	679	973	817					1114	1500	1618
90	134,7	1347	230	206	916	1266	1084					1541	1444	1549
80	130,9	1309	303	283	1255	1668	1457					2166	1390	1483
70	127,1	1271	404	395	1752	2228	1990					3098	1337	1417
65	125,2	1252	469	469	2083	2588	2338					3732	1311	1385
60	123,2	1232	547	560	2488	3020	2760		10000			4518	1285	1353
55	121,3	1213	640	672	2986	3536	3270					5494	1260	1322
50	119,4	1194	753	811	3602	4160	3893		10830	10000		6718	1235	1291
45	117,5	1175	888	984	4368	4911	4655			10830		8260	1210	1260
40	115,5	1155	1052	1199	5324	5827	5594		11670	11670	10000	10212	1186	1230
35	113,6	1136	1252	1471	6532	6940	6754			12500	10625	12698	1162	1200
30	111,7	1117	1498	1814	8055	8313	8196	10000	12500	13330	11250	15886	1138	1171
29	111,3	1113	1553	1893	8406	8622	8525	10170				16627	1132	1165
28	111,0	1110	1611	1977	8779	8944	8869	10330				17407	1128	1159
27	110,5	1105	1671	2064	9165	9281	9229	10500				18227	1123	1153
26	110,1	1101	1734	2156	9574	9632	9606	10670				19090	1119	1147
<b>25</b>	<b>109,7</b>	<b>1097</b>	<b>1800</b>	<b>2252</b>	<b>10000</b>	<b>10000</b>	<b>10000</b>	10830		14170	11875	<b>20000</b>	1114	1141
24	109,3	1093	1868	2353	10448	10380	10413	11000				20958	1109	1136
23	109,0	1090	1940	2460	10924	10780	10845	11170				21968	1105	1130
22	108,6	1086	2015	2572	11421	11200	11298	11330				23033	1100	1124
21	108,2	1082	2092	2689	11940	11630	11773	11500				24156	1095	1118
20	107,8	1078	2174	2813	12491	12090	12270	11670	13330	15000	12500	25340	1091	1112
19	107,4	1074	2258	2944	13073	12560	12791	11830				26491	1086	1107
18	107,0	1070	2347	3081	13681	13060	13337	12000				27912	1081	1101
17	106,6	1066	2440	3226	14325	13580	13910	12170				29307	1077	1095
16	106,2	1062	2537	3378	15000	14120	14510	12330				30782	1072	1089
15	105,9	1059	2638	3538	15710	14690	15140	12500			13125	32340	1068	1084
14	105,5	1055	2744	3707	16461	15280	15801	12370				33982	1063	1078
13	105,1	1051	2854	3886	17256	15900	16494	12830				35716	1058	1072
12	104,7	1047	2972	4074	18091	16560	17222	13000				37550	1054	1067
11	104,3	1043	3093	4272	18970	17240	17987	13170				39489	1049	1061
10	103,9	1039	3222	4482	19902	17960	18790	13330	14170		13750	41540	1045	1056
9	103,5	1035	3354	4703	20884	18700	19633	13500				43715	1040	1050
8	103,1	1031	3493	4936	21918	19480	20519	13670				46018	1036	1044
7	102,7	1027	3639	5183	23015	20300	21451	13830				48457	1031	1039
6	102,3	1023	3791	5443	24170	21150	22430	14000				51041	1027	1033
5	101,9	1019	3951	5718	25391	22050	23460	14170			14375	53780	1022	1028
4	101,6	1016	4120	6009	26683	23000	24545	14330				56678	1018	1022
3	101,2	1012	4296	6317	28051	23990	25687	14500				59751	1013	1016
2	100,8	1008	4481	6643	29498	25030	26890	14670				63011	1009	1011
1	100,4	1004	4677	6988	31030	26130	28156	14830				66469	1004	1005
<b>0</b>	<b>100,0</b>	<b>1000</b>	4882	7353	32650	27280	29490	15000	15000		15000	70140	<b>1000</b>	<b>1000</b>
-5	98,0	980	6059	9532	42327	33900	37310					92220	978	973
-10	96,1	961	7580	12460	55329	42470	47540					122260	956	946
-15	94,1	941	9519	16430	72957	53410	61020					163480	935	919
-20	92,2	922	12061	21863	97083	67770	78910					220600	914	893
-25	90,2	902	15359	29371	130422	86430	102900					300400	893	867
-30	88,2	882	19747	39855	176976	111300	135200					413400	872	842
-35	86,3	863											851	816
-40	84,3	843											831	791

## TEMPERATURE TRANSMITTER FOR ROOM MOUNTING, 0...10 V AND MODBUS

Technical data	
Supply voltage	24 V AC $\pm 10\%$ / 15...35 V DC
Power consumption	< 1 W
Temperature range	0...50 °C
Ambient temperature	0...50 °C
Ambient humidity	10...90 % UR (senza condensa)
Voltage range	0...11.5 V DC
Transformer power	$\geq 2$ VA
Mounting	Room
Display	4 digit
Dimensions	100 x 85 x 30.5 mm
Protection class	IP30
Isolation class	III

Article	Output signal	Accuracy	Display
TTA	0...10 V DC	$\pm 0.4^\circ\text{C}$	-
TTA-D	0...10 V DC	$\pm 0.4^\circ\text{C}$	X
TTA-M	Modbus	$\pm 0.4^\circ\text{C}$	-
TTA-D-M	Modbus	$\pm 0.4^\circ\text{C}$	X



TTA



TTA-D

## TEMPERATURE TRANSMITTER FOR ROOM MOUNTING, 4...20 mA

Technical data	
Supply voltage	Max. 28 V DC, Min. $11+(0.02 \times RL)$ V DC
DC power	Min. 1 W
Temperature range	0...50 °C
Ambient temperature	0...50 °C
Ambient humidity	10...95 % RH
Power consumption	0.6 W
Accuracy, temperature	$\pm 0.5^\circ\text{C}$ at 20°C
Mounting	Room
Dimensions (WxHxD mm)	100 x 85 x 30.5
Protection class	IP30
Isolation class	III

Article	Output signal	Display
TTA-CD	4...20 mA (2 wires)	X (4 digits)
TTA-C	4...20mA (2 wires)	-



TTA-C



TTA-CD

## TEMPERATURE TRANSMITTER FOR WALL MOUNTING, IP65



TTE

Technical data	
Power consumption	< 1 W
Ambient temperature	-20...+50 °C
Ambient humidity	10...95 % RH
Storage temperature	-20...+70 °C
Material, casing cover	White polycarbonate
Material, casing base	Grey polycarbonate
Weight	170 g
Dimensions	75 x 75 x 36 mm (housing)
Protection class	IP65 class III (sensor excluded)
Isolation class	III

Article	Temperature range	Output signal	Accuracy	Supply voltage
TTE011	0...50 °C	0...10 V DC	± 1°C	18...35 V DC / 18...24 V AC
TTE012	-30...+50 °C	0...10 V DC	± 1,5°C	18...35 V DC / 18...24 V AC
TTE013	0...100 °C	0...10 V DC	± 2°C	18...35 V DC / 18...24 V AC
TTE021	0...50 °C	4...20 mA (2 wires)	± 1°C	Max 30 V DC, Min 11+(0,02xRL) V DC
TTE022	-30...+50 °C	4...20 mA (2 wires)	± 1,5°C	Max 30 V DC, Min 11+(0,02xRL) V DC
TTE023	0...100 °C	4...20 mA (2 wires)	± 2°C	Max 30 V DC, Min 11+(0,02xRL) V DC

## TEMPERATURE TRANSMITTER FOR AIR DUCT MOUNTING, IP65



TTC



DBZ-22

Technical data	
Power consumption	< 1 W
Temperature range sensor	-20...+80 °C
Insertion length	60...230 mm
Ambient temperature	0...50 °C
Ambient humidity	10...95 % RH (non-condensing)
Storage temperature	-20...+70 °C
Material, casing cover	White polycarbonate
Material, casing base	Grey polycarbonate
Weight	260 g
Dimensions	75 x 75 x 36 mm (housing)
Protection class	IP65 (sensor excluded)
Isolation class	III

Article	Temperature range	Output signal	Accuracy	Supply voltage
TTC011	0...50 °C	0...10 V DC	± 1°C	18...35 V DC / 18...24 V AC
TTC012	-30...+50 °C	0...10 V DC	± 1,5°C	18...35 V DC / 18...24 V AC
TTC013	0...100 °C	0...10 V DC	± 2°C	18...35 V DC / 18...24 V AC
TTC021	0...50 °C	4...20 mA (2 wires)	± 1°C	Max 30 V DC, Min (11+(0,02xRL)) V DC
TTC022	-30...+50 °C	4...20 mA (2 wires)	± 1,5°C	Max 30 V DC, Min (11+(0,02xRL)) V DC
TTC023	0...100 °C	4...20 mA (2 wires)	± 2°C	Max 30 V DC, Min (11+(0,02xRL)) V DC

Article	Description
DBZ-22	Mounting bracket for air duct transmitters



The transmitter is supplied with mounting bracketed model DBZ-22

## TEMPERATURE TRANSMITTER FOR IMMERSION MOUNTING, IP65



TTI

Technical data	
Power consumption	< 1 W
Temperature range sensor	-20...+100 °C
Insertion length	120 mm
Ambient temperature	0...50 °C
Ambient humidity	10...95 % RH (non-condensing)
Storage temperature	-20...+70 °C
Material, casing cover	White polycarbonate
Material, casing base	Grey polycarbonate
Weight	310
Dimensions	75 x 75 x 36 mm (housing)
Protection class	IP65 (sensor excluded)
Isolation class	III

Article	Temperature range	Output signal	Accuracy	Supply voltage
TTI011	0...50 °C	0...10 V DC	± 1°C	18...35 V DC / 18...24 V AC
TTI012	-30...+50 °C	0...10 V DC	± 1,5°C	18...35 V DC / 18...24 V AC
TTI013	0...100 °C	0...10 V DC	± 2°C	18...35 V DC / 18...24 V AC
TTI021	0...50 °C	4...20 mA (2 wires)	± 1°C	Max 30 V DC, Min (11+(0,02xRL)) V DC
TTI022	-30...+50 °C	4...20 mA (2 wires)	± 1,5°C	Max 30 V DC, Min (11+(0,02xRL)) V DC
TTI023	0...100 °C	4...20 mA (2 wires)	± 2°C	Max 30 V DC, Min (11+(0,02xRL)) V DC

# CO<sub>2</sub>, CO, VOC transmitters

## CO<sub>2</sub> TRANSMITTER, ROOM MOUNTING

This series with automatic calibration sets new standards in CO<sub>2</sub> measurement for HVAC applications. It combines the measurement of the carbon dioxide level, temperature and relative humidity. Models with or without display are available.



TCO2A



Technical data	
Supply voltage	24 V AC ±10 %, 50...60 Hz / 15...35 V DC
Working range, CO <sub>2</sub>	0...2000 ppm
Working range, temperature	0...50 °C
Working range, humidity	10...90 % RH (non-condensing)
Power consumption	< 2.5 W
Energy consumption	< 0.5 Wh
Transformer power	≥ 5 VA
Accuracy, CO <sub>2</sub>	< ± (50 ppm + 2 % of the measured value) (25 °C)
Accuracy, humidity	±3 % RH (20°C)
Relay output	Max. 1 A at 50 V AC, min. 1 mA at 5 V DC
Mounting	Room
Dimensions	100 x 85 x 30.5 mm
Protection class	IP30

Outputs	
CO <sub>2</sub>	0...10 V DC referring to 0...2000 ppm
Temperature	0...10 V DC referring to 0...50 °C or resistive outputs
Humidity	0...10 V DC referring to 0...100 % RH

Article	Description	Display	Output signal	Accuracy, temperature
TCO2A	CO <sub>2</sub> + °C	-	0...10 V + 0...10 V	± 0.4 °C
TCO2A-D	CO <sub>2</sub> + °C	X	0...10 V + 0...10 V	± 0.4 °C
TCO2A-PT100	CO <sub>2</sub> + PT100, 100 Ohm (0°C)	-	0...10 V + ohm	± 0.3 °C
TCO2A-PT1000	CO <sub>2</sub> + PT1000, 1000 Ohm (0°C)	-	0...10 V + ohm	± 0.3 °C
TCO2A-NTC1.8	CO <sub>2</sub> + NTC 1.8, 1800 Ohm (25°C)	-	0...10 V + ohm	± 0.5 °C
TCO2A-NTC2.2	CO <sub>2</sub> + NTC 2.2, 2252 Ohm (25°C)	-	0...10 V + ohm	± 0.2 °C
TCO2A-NTC10-01	CO <sub>2</sub> + NTC 10, 10 kOhm (25°C)	-	0...10 V + ohm	± 0.2 °C
TCO2A-NTC10-02	CO <sub>2</sub> + NTC 10, 10 kOhm (25°C)	-	0...10 V + ohm	± 0.3 °C
TCO2A-NTC10-03	CO <sub>2</sub> + NTC 10, 10 kOhm (25°C)	-	0...10 V + ohm	± 0.25 °C
TCO2A-NTC20	CO <sub>2</sub> + NTC 20, 20 kOhm (25°C)	-	0...10 V + ohm	± 0.2 °C
TCO2A-NI1000-01	CO <sub>2</sub> + Ni1000, 1000 Ohm (0°C)	-	0...10 V + ohm	± 0.5 °C
TCO2A-NI1000-02	CO <sub>2</sub> + Ni1000, 1000 Ohm (0°C)	-	0...10 V + ohm	± 0.5 °C
TCO2A-D-PT100	CO <sub>2</sub> + PT100, 100 Ohm (0°C)	X	0...10 V + ohm	± 0.3 °C
TCO2A-D-PT1000	CO <sub>2</sub> + PT1000, 1000 Ohm (0°C)	X	0...10 V + ohm	± 0.3 °C
TCO2A-D-NTC1.8	CO <sub>2</sub> + NTC 1.8, 1800 Ohm (25°C)	X	0...10 V + ohm	± 0.5 °C
TCO2A-D-NTC2.2	CO <sub>2</sub> + NTC 2.2, 2252 Ohm (25°C)	X	0...10 V + ohm	± 0.2 °C
TCO2A-D-NTC10-01	CO <sub>2</sub> + NTC 10, 10 kOhm (25°C)	X	0...10 V + ohm	± 0.2 °C
TCO2A-D-NTC10-02	CO <sub>2</sub> + NTC 10, 10 kOhm (25°C)	X	0...10 V + ohm	± 0.3 °C
TCO2A-D-NTC10-03	CO <sub>2</sub> + NTC 10, 10 kOhm (25°C)	X	0...10 V + ohm	± 0.25 °C
TCO2A-D-NTC20	CO <sub>2</sub> + NTC 20, 20 kOhm (25°C)	X	0...10 V + ohm	± 0.2 °C
TCO2A-D-NI1000-01	CO <sub>2</sub> + Ni1000, 1000 Ohm (0°C)	X	0...10 V + ohm	± 0.5 °C
TCO2A-D-NI1000-02	CO <sub>2</sub> + Ni1000, 1000 Ohm (0°C)	X	0...10 V + ohm	± 0.5 °C
TCO2A-M	CO <sub>2</sub> + °C	-	Modbus	± 0.4 °C
TCO2A-D-M	CO <sub>2</sub> + °C	X	Modbus	± 0.4 °C
TCO2AU	CO <sub>2</sub> + °C + RH	-	0...10 V + 0...10 V + 0...10 V	± 0.4 °C
TCO2AU-PT100	CO <sub>2</sub> + RH + PT100, 100 Ohm (0°C)	-	0...10 V + 0...10 V + ohm	± 0.3 °C
TCO2AU-PT1000	CO <sub>2</sub> + RH + PT1000, 1000 Ohm (0°C)	-	0...10 V + 0...10 V + ohm	± 0.3 °C

Article	Description	Display	Output signal	Accuracy, temperature
TCO2AU-NTC1.8	CO <sub>2</sub> + RH + NTC 1.8, 1800 Ohm (25°C)	-	0...10 V + 0...10 V + ohm	± 0.5 °C
TCO2AU-NTC2.2	CO <sub>2</sub> + RH + NTC 2.2, 2252 Ohm (25°C)	-	0...10 V + 0...10 V + ohm	± 0.2 °C
TCO2AU-NTC10-01	CO <sub>2</sub> + RH + NTC 10, 10 kOhm (25°C)	-	0...10 V + 0...10 V + ohm	± 0.2 °C
TCO2AU-NTC10-02	CO <sub>2</sub> + RH + NTC 10, 10 kOhm (25°C)	-	0...10 V + 0...10 V + ohm	± 0.3 °C
TCO2AU-NTC10-03	CO <sub>2</sub> + RH + NTC 10, 10 kOhm (25°C)	-	0...10 V + 0...10 V + ohm	± 0.25 °C
TCO2AU-NTC20	CO <sub>2</sub> + RH + NTC 20, 20 kOhm (25°C)	-	0...10 V + 0...10 V + ohm	± 0.2 °C
TCO2AU-NI1000-01	CO <sub>2</sub> + RH + Ni1000, 1000 Ohm (0°C)	-	0...10 V + 0...10 V + ohm	± 0.5 °C
TCO2AU-NI1000-02	CO <sub>2</sub> + RH + Ni1000, 1000 Ohm (0°C)	-	0...10 V + 0...10 V + ohm	± 0.5 °C
TCO2AU-D	CO <sub>2</sub> + °C + RH	X	0...10 V + 0...10 V + 0...10 V	± 0.4 °C
TCO2AU-D-PT100	CO <sub>2</sub> + RH + PT100, 100 Ohm (0°C)	X	0...10 V + 0...10 V + ohm	± 0.3 °C
TCO2AU-D-PT1000	CO <sub>2</sub> + °C + RH	X	0...10 V + 0...10 V + ohm	± 0.3 °C
TCO2AU-D-NTC1.8	CO <sub>2</sub> + RH + NTC 1.8, 1800 Ohm (25°C)	X	0...10 V + 0...10 V + ohm	± 0.5 °C
TCO2AU-D-NTC2.2	CO <sub>2</sub> + RH + NTC 2.2, 2252 Ohm (25°C)	X	0...10 V + 0...10 V + ohm	± 0.2 °C
TCO2AU-D-NTC10-01	CO <sub>2</sub> + RH + NTC 10, 10 kOhm (25°C)	X	0...10 V + 0...10 V + ohm	± 0.2 °C
TCO2AU-D-NTC10-02	CO <sub>2</sub> + RH + NTC 10, 10 kOhm (25°C)	X	0...10 V + 0...10 V + ohm	± 0.3 °C
TCO2AU-D-NTC10-03	CO <sub>2</sub> + RH + NTC 10, 10 kOhm (25°C)	X	0...10 V + 0...10 V + ohm	± 0.25 °C
TCO2AU-D-NTC20	CO <sub>2</sub> + RH + NTC 20, 20 kOhm (25°C)	X	0...10 V + 0...10 V + ohm	± 0.2 °C
TCO2AU-D-NI1000-01	CO <sub>2</sub> + RH + Ni1000, 1000 Ohm (0°C)	X	0...10 V + 0...10 V + ohm	± 0.5 °C
TCO2AU-D-NI1000-02	CO <sub>2</sub> + RH + Ni1000, 1000 Ohm (0°C)	X	0...10 V + 0...10 V + ohm	± 0.5 °C
TCO2AU-M	CO <sub>2</sub> + RH + °C	-	Modbus	± 0.4°C
TCO2AU-D-M	CO <sub>2</sub> + RH + °C	X	Modbus	± 0.4°C

## DUCT AIR QUALITY TRANSMITTERS, VOC

Analysis of the air quality based on a mixed gas VOC (Volatile Organic Compounds) sensor.

Detectable gases:

- carbon monoxide CO
- hydrogen sulfide H<sub>2</sub>S
- solvent vapours
- cigarette smoke
- car exhaust
- air produced by human breathing
- combustion smoke from wood, paper and plastics.



DB-KLQ

### Technical data

Supply voltage	15...36 V DC or 24 V AC/DC ± 10%, 50-60 Hz
Outputs	0...10 V DC, 0...20 mA or 4...20 mA, selectable by dip-switch
Sensor	VOC
Ambient temperature	0...50 °C
Ambient humidity	10...90 % RH (non-condensing)
Storage temperature	-20...+50 °C
Storage humidity	< 95 % RH
Casing	Plastic material similar to RAL 9010
Weight	80 g
Dimensions	65 x 59 x 36 mm (tube L = 206 mm, diameter = 16 mm)
Protection class	IP30 (case)
Isolation class	III
Certification	EN 60335-1: safety / EN 60529: IP degree of protection / EN 60730: domestic controls

Article	Output	Application
DB-KLQ	0...10 V DC, 0...20 mA, 4...20 mA	Duct
DB-KLQ5	0...5 V DC, 0...20 mA, 4...20 mA	Duct

## CO<sub>2</sub> TRANSMITTER, AIR DUCT MOUNTING

Measures the concentration of carbon dioxide in ducts. Exempt from periodic calibration. Some models are equipped with a passive temperature sensor.



TCO2C

Technical data	
Supply voltage	15...35 V DC / 24 V AC ± 10% 50-60 Hz
CO <sub>2</sub> sensor	NDIR (Non-Dispersive Infrared Technology)
Output	0...10 V DC or 0...5 V DC, RL>10 kOhm
Working range, CO <sub>2</sub>	0...2000 ppm
Working range, temperature	0...+50 °C
Working range, humidity	10...90 % RH (non-condensing)
Storage temperature	-20...+70 °C
Storage humidity	< 95 % RH
Accuracy, CO <sub>2</sub>	±(50 ppm +2% of the measured value)
Power consumption	< 2.5 W
Energy consumption	< 0.5 Wh
Transformer power	>=5 VA
Max. air velocity	10 m/s
Mounting	Duct
Material, casing cover	White polycarbonate
Material, casing base	Grey polycarbonate
Insertion length	60...230 mm
Weight	160 g
Dimensions	75 x 77 x 36 mm (housing)
Protection class	IP65 case (sensor excluded)
Isolation class	III
Outputs	
CO <sub>2</sub>	0...10 V DC referring to 0...2000 ppm
Temperature	passive sensor °C

Article	Description	Output signal	Accuracy, temperature
TCO2C	CO <sub>2</sub>	0...10 V	-
TCO2C-05	CO <sub>2</sub>	0...5 V	-
TCO2C-PT100	CO <sub>2</sub> + PT100, 100 Ohm (0°C)	0...10 V + Ohm	± 0.3
TCO2C-PT1000	CO <sub>2</sub> + PT1000, 1000 Ohm (0°C)	0...10 V + Ohm	± 0.3
TCO2C-NTC1.8	CO <sub>2</sub> + NTC 1.8, 1800 Ohm (25°C)	0...10 V / Ohm	± 0.5
TCO2C-NTC2.2	CO <sub>2</sub> + NTC 2.2, 2252 Ohm (25°C)	0...10 V + Ohm	± 0.2
TCO2C-NTC10-01	CO <sub>2</sub> + NTC 10, 10 kOhm (25°C)	0...10 V + Ohm	± 0.2
TCO2C-NTC10-02	CO <sub>2</sub> + NTC 10, 10 kOhm (25°C)	0...10 V + Ohm	± 0.3
TCO2C-NTC10-03	CO <sub>2</sub> + NTC 10, 10 kOhm (25°C)	0...10 V + Ohm	± 0.25
TCO2C-NTC20	CO <sub>2</sub> + NTC 20, 20 kOhm (25°C)	0...10 V + Ohm	± 0.2
TCO2C-NI1000-01	CO <sub>2</sub> + Ni1000, 1000 Ohm (0°C)	0...10 V + Ohm	± 0.5
TCO2C-NI1000-02	CO <sub>2</sub> + Ni1000, 1000 Ohm (0°C)	0...10 V + Ohm	± 0.5

### ACCESSORIES

Article	Description
DBZ-22	Mounting bracket for air duct transmitters



DBZ-22



Note: The transmitter is supplied with mounting bracketed model DBZ-22



## CARBON MONOXIDE TRANSMITTER

This device measures the carbon monoxide concentration using an electrochemical method of measurement characterised by high selectivity even in low concentrations. It is installed for both safety and energy-saving reasons. The output signals are linear representations of the gas concentration.

The transmitter is TÜV-approved in accordance with VDI 2053.



TC01

Technical data	
Supply voltage	12...28 V DC
Measuring range	0...300 ppm
Outputs	4...20 mA, two-wire / 0...10 V DC, three-wire
Calibration	Automatic zero adjustment
Dimensions	80 x 82 x 86 mm
Protection class	IP56

Article	Description
TC01	CO transmitter

## ROOM AIR QUALITY TRANSMITTERS, VOC

Analysis of the air quality based on a mixed gas VOC (Volatile Organic Compounds) sensor.

Detectable gases:

- carbon monoxide CO
- hydrogen sulfide H<sub>2</sub>S
- solvent vapours
- cigarette smoke
- car exhaust
- air produced by human breathing
- combustion smoke from wood, paper and plastics.



DB-RLQ

5

Technical data	
Supply voltage	15...36 V DC or 24 V AC/DC ± 10%, 50-60 Hz
Outputs	0...10 V DC, 0...20 mA or 4...20 mA, selectable by jumpers
Sensor	VOC
Ambient temperature	0...50 °C
Ambient humidity	10...90 % RH (non-condensing)
Storage temperature	-20...+50 °C
Storage humidity	< 95 % RH
Casing	Plastic material similar to RAL 9010
Weight	80 g
Dimensions	75 x 75 x 25 mm
Protection class	IP30 (case)
Isolation class	III
Certification	EN 60335-1: safety / EN 60529: IP degree of protection / EN 60730: domestic controls

Article	Output	Application
DB-RLQ	0...10 V DC, 0...20 mA, 4...20 mA	Room
DB-RLQ5	0...5 V DC, 0...20 mA, 4...20 mA	Room

# Humidity transmitters and humidistats

## ROOM HUMIDISTAT

Electromechanical humidistat for room mounting with synthetic element.



DBZH-101

Technical data	
Sensor element	Synthetic element
Contact	Dust-tight microswitches with SPDT contacts
Switch capacity	Humidify: 2 (1) A, 230 V AC Dehumidify: 5 (1) A, 230 V AC
Output	
Humidity range	30...100 % RH
Setpoint	30...100 % RH
Hysteresis	4 % at 50 % RH
Air velocity range	0.2...8 m/s
Time constant	$t_{50}$ at 2 m/s: 72 s at an air velocity of 2 m / s
Temperature coefficient	$\pm 0.2$ %/K at 23 °C
Ambient temperature	0...60 °C
Ambient humidity	< 95 % RH (non-condensing)
Storage temperature	-20...+60 °C
Storage humidity	< 95 % RH (In the case of voltage below 48 V, the humidistat can be used up to 100% RH)
Casing	ABS
Weight	130 g
Dimensions	115 x 70 x 35 mm
Protection class	IP20
Isolation class	II

Article	Hidden setpoint
DBZH-101	-
DBZH-101U	X

## ROOM HUMIDISTAT

Electromechanical humidistat with a synthetic element. The setpoint knob can be locked.



DBZH-102

Technical data	
Sensor element	Synthetic element
Output	One, 230 V AC, 5 A, change-over
Setpoint	35...95 % RH
Hysteresis	7 % RH
Mounting	Room
Dimensions	86 x 86 x 30 mm
Protection class	IP30

Article	Description
DBZH-102	Room humidistat, 1-step

## DUCT HUMIDISTAT

Humidistat to be mounted in the duct.



DBKH-10

Technical data	
Sensor element	Synthetic element
Contact	Microswitches with SPDT contacts
Switch capacity	15 (2) A, 230 V AC/0.25 A, 230 V DC
Humidity range	30...100 % RH
Hysteresis	4 % at 50% RH
Max. air velocity	8 m/s
Ambient temperature	0...60 °C °C
Ambient humidity	< 95 % RH (non-condensing)
Storage temperature	-30...+60 °C
Storage humidity	< 95 % RH (In the case of voltage below 48 V, the humidistat can be used up to 100% RH)
Tube length	220 mm
Material, tube	Nickel-plated brass, perforated
Casing	ABS
Weight	480 g
Dimensions	108 x 70 x 72 mm

Article	Hidden setpoint	Protection class
DBKH-10	-	IP54
DBKH-10U	X	IP65

## DUCT/WALL HUMIDISTAT

Electromechanical humidistat with change-over contact.



DBKH-10H

Technical data	
Sensor element	Human hair
Output	10 A, 250 V AC, change-over
Setpoint	10...100 % RH
Hysteresis	3 % RH
Mounting	Duct or wall
Dimensions	80 x 85 x 88 mm
Protection class	IP54
Isolation class	I

Article	Description	Output	Step differential
DBKH-10H	Duct/wall humidistat	1-step	-
DBKH-20H	Duct/wall humidistat	2-step	0...25 % RH

## HUMIDITY TRANSMITTER FOR ROOM MOUNTING, OUTPUT 0...10 V, IP30

Transmitters for relative humidity and temperature measurement. They have good long-term stability and are resistant to contamination.



TUA



TUA-D

Technical data	
Supply voltage	24 V AC $\pm$ 10% / 15...35 V DC
Power consumption	< 1 W
Transformer power	$\geq$ 2 VA
Output signal	0...10 V DC or Modbus
Ambient temperature	0...50 °C
Ambient humidity	0...95%
Working range, temperature	0...50 °C
Working range, humidity	0...100 % RH
Accuracy, humidity	$\pm$ 3 % RH at 20 °C
Mounting	Room
Dimensions	100 x 85 x 30.5 mm
Protection class	IP30
Isolation class	III

Article	Output signal	Display
TUA-M	Modbus	-
TUA-D-M	Modbus	X
TUA	0...10 V DC	-
TUA-D	0...10 V DC	X

## HUMIDITY TRANSMITTER FOR ROOM MOUNTING, OUTPUT 4...20 MA, IP30

Technical data	
Supply voltage	Max 28 V DC, Min (11+(0,02xRL)) V DC
Output signal	4...20 mA (2 wire)
Power consumption	0,6 W
Ambient temperature	0...50 °C
Ambient humidity	0...95% RH (non condensing)
Transformer power	>=1 W
Working range, humidity	0...100 % RH (non condensing)
Accuracy, humidity	±3 % RH at 20 °C
Mounting	Room
Dimensions	100 x 85 x 30.5 mm
Protection class	IP30
Isolation class	III

Article	Display
TUA-C	-
TUA-CD	X



TUA-C



TUA-CD

## HUMIDITY AND TEMPERATURE TRANSMITTER FOR ROOM MOUNTING, 4...20 MA

Technical data	
Supply voltage	Max. 28 V DC, Min. 11+(0.02xRL) V DC
Output signal	4...20 mA (2 wire)
Power consumption	1.2 W
Temperature range	0...50 °C
Ambient temperature	0...50 °C
Ambient humidity	0...95 % RH (non-condensing)
Humidity range	0...100 % RH
Transformer power	Min. 2 W
Accuracy, humidity	±3% RH at 20 °C
Accuracy, temperature	±0.5°C at 20°C
Mounting	Room
Dimensions (WxHxD mm)	100 x 85 x 30.5
Protection class	IP30
Isolation class	III

Article	Display
TTUA-C	-
TTUA-CD	X



TTUA-C



TTUA-CD

## HUMIDITY AND TEMPERATURE TRANSMITTER FOR ROOM MOUNTING, IP30

Transmitter for relative humidity and temperature measurement. It has good long-term stability and is resistant to contamination.



TTUA



TTUA-D

### Technical data

Supply voltage	24 V AC $\pm 10\%$ / 15...35 V DC
Power consumption	< 1 W
Transformer power	$\geq 2$ VA
Working range, temperature	0...50 °C
Working range, humidity	0...100 % RH
Accuracy, humidity	$\pm 3\%$ RH at 20°C
Mounting	Room
Dimensions	100 x 85 x 30.5 mm
Protection class	IP30

Article	Description	Display	Output signal	Accuracy, temperature
TTUA	RH + °C	-	0...10 V + 0...10 V	$\pm 0.4$ °C
TTUA-PT100	RH + PT100, 100 Ohm (0°C)	-	0...10 V + ohm	$\pm 0.3$ °C
TTUA-PT1000	RH + PT1000, 1000 Ohm (0°C)	-	0...10 V + ohm	$\pm 0.3$ °C
TTUA-NTC1.8	RH + NTC 1.8, 1800 Ohm/25°C	-	0...10 V + ohm	$\pm 0.5$ °C
TTUA-NTC2.2	RH + NTC 2.2, 2252 Ohm/25°C	-	0...10 V + ohm	$\pm 0.2$ °C
TTUA-NTC10-01	RH + NTC 10, 10 kOhm/25°C	-	0...10 V + ohm	$\pm 0.2$ °C
TTUA-NTC10-02	RH + NTC 10, 10 kOhm/25°C	-	0...10 V + ohm	$\pm 0.3$ °C
TTUA-NTC10-03	RH + NTC 10, 10 kOhm/25°C	-	0...10 V + ohm	$\pm 0.25$ °C
TTUA-NTC20	RH + NTC 20, 20 kOhm/25°C	-	0...10 V + ohm	$\pm 0.2$ °C
TTUA-NI1000-01	RH + Ni1000, 1000 Ohm/0°C	-	0...10 V + ohm	$\pm 0.5$ °C
TTUA-NI1000-02	RH + Ni1000, 1000 Ohm/0°C	-	0...10 V + ohm	$\pm 0.5$ °C
TTUA-D	RH + °C	X	0...10 V + 0...10 V	$\pm 0.4$ °C
TTUA-D-PT100	RH + PT100, 100 Ohm/0°C	X	0...10 V + ohm	$\pm 0.3$ °C
TTUA-D-PT1000	RH + PT1000, 1000 Ohm (0°C)	X	0...10 V + ohm	$\pm 0.3$ °C
TTUA-D-NTC1.8	RH + NTC 1.8, 1800 Ohm/25°C	X	0...10 V + ohm	$\pm 0.5$ °C
TTUA-D-NTC2.2	RH + NTC 2.2, 2252 Ohm/25°C	X	0...10 V + ohm	$\pm 0.2$ °C
TTUA-D-NTC10-01	RH + NTC 10, 10 kOhm/25°C	X	0...10 V + ohm	$\pm 0.2$ °C
TTUA-D-NTC10-02	RH + NTC 10, 10 kOhm/25°C	X	0...10 V + ohm	$\pm 0.3$ °C
TTUA-D-NTC10-03	RH + NTC 10, 10 kOhm/25°C	X	0...10 V + ohm	$\pm 0.25$ °C
TTUA-D-NTC20	RH + NTC 20, 20 kOhm/25°C	X	0...10 V + ohm	$\pm 0.2$ °C
TTUA-D-NI1000-01	RH + Ni1000, 1000 Ohm/0°C	X	0...10 V + ohm	$\pm 0.5$ °C
TTUA-D-NI1000-02	RH + Ni1000, 1000 Ohm/0°C	X	0...10 V + ohm	$\pm 0.5$ °C
TTUA-M	RH + C°	-	Modbus	$\pm 0.4$ °C
TTUA-D-M	RH + °C	X	Modbus	$\pm 0.4$ °C

## WALL HUMIDITY TRANSMITTER, IP65

Technical data	
Supply voltage, 0...10 V DC	18...24 V AC / 18...35 V DC
Supply voltage, 4...20 mA	Max 30 V DC, Min (11+(0,02xRL)) V DC
Power consumption	< 1 W
Transformer power	≥ 2 VA
Ambient humidity	10...95 % RH (non-condensing)
Ambient temperature	-20...+50 °C
Storage temperature	-20...+70 °C
Accuracy	±3 % RH at 20 °C
Temperature dependence of electronics	Output 4...20 mA: 0.015 °C/°C
Material, casing cover	White polycarbonate
Material, casing base	Grey polycarbonate
Weight	170 g
Dimensions	75 x 172 x 36 mm
Protection class	IP65 (sensor excluded)
Isolation class	III



TUE

Article	Supply voltage	Load limits	Output signal
TUE1	18...24 V AC / 18...35 V DC	RL < 1000 Ohm	0...10 V DC
TUE2	11...30 V DC	V+ - (0.02 x RL) ≥ 11 V]	4...20 mA
TUE3	18...24 V AC / 18...35 V DC	RL < 1000 Ohm	0...5 V DC



## WALL HUMIDITY/TEMPERATURE TRANSMITTER, IP65



TUTE

### Technical data

Power consumption	
Ambient humidity	10...95 % RH (non-condensing)
Storage temperature	-20...+70 °C
Ambient temperature	-20...+50 °C
Accuracy, humidity	± 3% RH at 20 °C
Material, casing cover	White polycarbonate
Material, casing base	Grey polycarbonate
Weight	170 g
Dimensions	75 x 172 x 36 mm
Protection class	IP65 (sensor excluded)
Isolation class	III

Article	Supply voltage	Temperature range	Output, temperature	Output, humidity	Accuracy, temperature
TUTE0111	18...24 V AC / 18...35 V DC	0...+50 °C	0...10 V DC	0...10 V DC	± 1°C
TUTE0121	18...24 V AC / 18...35 V DC	-30...+50 °C	0...10 V DC	0...10 V DC	± 1.5°C
TUTE0131	18...24 V AC / 18...35 V DC	0...+100 °C	0...10 V DC	0...10 V DC	± 2°C
TUTE0212	Max 30 V DC, Min 11+(0,02xRL) V DC	0...+50 °C	4...20 mA	4...20 mA	± 1°C
TUTE0222	Max 30 V DC, Min 11+(0,02xRL) V DC	-30...+50 °C	4...20 mA	4...20 mA	± 1.5°C
TUTE0232	Max 30 V DC, Min 11+(0,02xRL) V DC	0...+100 °C	4...20 mA	4...20 mA	± 2°C
TUTE1101	18...24 V AC / 18...35 V DC	-5...+50 °C	NTC 10K-02	0...10 V DC	± 0.6°C
TUTE1102	Max 30 V DC, Min 11+(0,02xRL) V DC	-5...+50 °C	NTC 10K-02	4...20 mA	± 0.6°C
TUTE1103	18...24 V AC / 18...35 V DC	-5...+50 °C	NTC 10K-02	0...5 V DC	± 0.6°C
TUTE1301	18...24 V AC / 18...35 V DC	-5...+50 °C	NTC 1K8	0...10 V DC	± 0.6°C
TUTE1302	Max 30 V DC, Min 11+(0,02xRL) V DC	-5...+50 °C	NTC 1K8	4...20 mA	± 0.6°C
TUTE1401	18...24 V AC / 18...35 V DC	-5...+50 °C	NTC 10K-01	0...10 V DC	± 0.2°C
TUTE1402	Max 30 V DC, Min 11+(0,02xRL) V DC	-5...+50 °C	NTC 10K-01	4...20 mA	± 0.2°C
TUTE1501	18...24 V AC / 18...35 V DC	-5...+50 °C	NTC 10K-03	0...10 V DC	± 0.2°C
TUTE1502	Max 30 V DC, Min 11+(0,02xRL) V DC	-5...+50 °C	NTC 10K-03	4...20 mA	± 0.2°C
TUTE1601	18...24 V AC / 18...35 V DC	-5...+50 °C	NTC 20K	0...10 V DC	± 0.6°C
TUTE1602	Max 30 V DC, Min 11+(0,02xRL) V DC	-5...+50 °C	NTC 20K	4...20 mA	± 0.6°C
TUTE1701	18...24 V AC / 18...35 V DC	-5...+50 °C	PT1000	0...10 V DC	± 0.6°C
TUTE2101	18...24 V AC / 18...35 V DC	-5...+50 °C	PT100	0...10 V DC	± 0.3°C
TUTE2102	Max 30 V DC, Min 11+(0,02xRL) V DC	-5...+50 °C	PT100	4...20 mA	± 0.3°C

## DUCT HUMIDITY TRANSMITTER

Technical data	
Supply voltage, 0...10 V DC	18...24 V AC / 18...35 V DC
Supply voltage, 4...20 mA	Max 30 V DC, Min (11+(0,02xRL)) V DC
Power consumption	< 1 W
Sensor	Capacitive
Ambient temperature	-20...+50 °C
Ambient humidity	10...95 % RH (non-condensing)
Storage temperature	-20...+70 °C
Accuracy	±3 % RH at 20 °C
Casing	Cover: white polycarbonate Base: grey polycarbonate
Weight	260 g
Dimensions	75 x 103 x 266 mm
Protection class	IP65
Isolation class	III



TUC

Article	Humidity range	Output signal
TUC1	0...100 % RH	0...10 V DC
TUC2	0...100 % RH	4...20 mA
TUC3	0...100 % RH	0...5 V DC

### ACCESSORY

Article	Description
DBZ-22	Mounting bracket for air duct transmitters



DBZ-22



*These transmitters are supplied with mounting bracket model DBZ-22.*

## DUCT HUMIDITY/TEMPERATURE TRANSMITTER



TUTC

Technical data	
Power consumption	< 1 W
Sensor	Temperature: resistive ; humidity: capacitive
Ambient humidity	10...95 % RH (non-condensing)
Ambient temperature	-20...+50 °C
Humidity range	0...100 % RH (non condensing)
Storage temperature	-20...+70 °C
Accuracy	Humidity: ± 3% RH at 20 °C Temperature: Max error 1 °C (range 0...50 °C) Max error 1.5 °C (range -30...+50 °C) Max error 2 °C (range 0...100 °C)
Casing	Cover: white polycarbonate Base: grey polycarbonate
Weight	260
Dimensions	75 x 103 x 266 mm
Protection class	IP65 (sensor excluded)
Isolation class	III

Article	Supply voltage	Temperature range	Output, temperature	Output, humidity
TUTC0111	18...24 V AC / 18...35 V DC	0...+50 °C	0...10 V DC	0...10 V DC
TUTC0121	18...24 V AC / 18...35 V DC	-30...+50 °C	0...10 V DC	0...10 V DC
TUTC0131	18...24 V AC / 18...35 V DC	0...+100 °C	0...10 V DC	0...10 V DC
TUTC0212	Max 30 V DC, Min 11+(0,02xRL) V DC	0...+50 °C	4...20 mA	4...20 mA
TUTC0222	Max 30 V DC, Min 11+(0,02xRL) V DC	-30...+50 °C	4...20 mA	4...20 mA
TUTC0232	Max 30 V DC, Min 11+(0,02xRL) V DC	0...+100 °C	4...20 mA	4...20 mA
TUTC1101	18...24 V AC / 18...35 V DC	-5...+50 °C	NTC 10K-02	0...10 V DC
TUTC1102	Max 30 V DC, Min 11+(0,02xRL) V DC	-5...+50 °C	NTC 10K-02	4...20 mA
TUTC1103	18...24 V AC / 18...35 V DC	-5...+50 °C	NTC 10K-02	0...5 V DC
TUTC1301	18...24 V AC / 18...35 V DC	-5...+50 °C	NTC 1K8	0...10 V DC
TUTC1302	Max 30 V DC, Min 11+(0,02xRL) V DC	-5...+50 °C	NTC 1K8	4...20 mA
TUTC1401	18...24 V AC / 18...35 V DC	-5...+50 °C	NTC 10K-01	0...10 V DC
TUTC1402	Max 30 V DC, Min 11+(0,02xRL) V DC	-5...+50 °C	NTC 10K-01	4...20 mA
TUTC1501	18...24 V AC / 18...35 V DC	-5...+50 °C	NTC 10K-03	0...10 V DC
TUTC1502	Max 30 V DC, Min 11+(0,02xRL) V DC	-5...+50 °C	NTC 10K-03	4...20 mA
TUTC1601	18...24 V AC / 18...35 V DC	-5...+50 °C	NTC 20K	0...10 V DC
TUTC1602	Max 30 V DC, Min 11+(0,02xRL) V DC	-5...+50 °C	NTC 20K	4...20 mA
TUTC1701	18...24 V AC / 18...35 V DC	-5...+50 °C	PT1000	0...10 V DC
TUTC2101	18...24 V AC / 18...35 V DC	-5...+50 °C	PT100	0...10 V DC
TUTC2102	Max 30 V DC, Min 11+(0,02xRL) V DC	-5...+50 °C	PT100	4...20 mA

### ACCESSORY

Article	Description
DBZ-22	Mounting bracket for air duct transmitters



These transmitters are supplied with mounting bracket model DBZ-22.

# Flow, air and liquid switches and transmitters

## LIQUID FLOW SWITCHES

Switches for liquid flow control.

Well-suited for:

- heating and air conditioning systems
- refrigeration systems.



DB25MI

Technical data	
Media	Water, Water max. 50% glycol
Contacts	Microswitch with SPDT contacts
Switch capacity	5 A, 250 V AC
Media temperature	-20...+110 °C
Storage temperature	-20...+70 °C
Storage humidity	< 95 % RH
Max. pressure	2500 kPa = 25 bar
Pressure loss at $Q_{max}$	1 kPa = 0.01 bar
Tolerance	± 15 % end of scale
Hysteresis	Min. 0.7 l/min
Plug	Internally threaded connector DIN 43650-A
Casing	ABS V0
Body	Brass
Paddles	Stainless steel
Packing	NBR
Weight	300...990 g
Dimensions	102 x 30 x 83...104 mm
Protection class	IP65
Isolation class	II

Article	Connection	Setting range	Max. recommended flow (l/min)
DB10MI	3/8"	5 - 6 l/min (H <sub>2</sub> O)	10 l/min (H <sub>2</sub> O)
DB15MI	1/2"	6 - 7 l/min	20 l/min
DB20MI	3/4"	7.5 - 11 l/min	40 l/min
DB20MI/1	3/4"	13 - 16 l/min	40 l/min
DB25MI	1"	19 - 24 l/min	60 l/min
DB32MI	1 1/4"	30 - 50 l/min	80 l/min
DB40MI	1 1/2"	50 - 60 l/min	100 l/min
DB50MI	2"	70 - 90 l/min	150 l/min



*The indicated values have been measured with the flow switch mounted horizontally.*

## LIQUID FLOW SWITCH

Electromechanical flow switches, suited for pipes of industrial plants: heating and air conditioning, refrigeration systems and heat pumps. Available in brass (suitable for normal media), and stainless steel AISI 316L (compatible with certain aggressive media).

### Technical data

Media	Water, Water max. 50% glycol
Contacts	Microswitch with switching contacts SPDT
Switch capacity	15 (8) A, 24...250 V AC
Ambient temperature	-40...+85 °C
Ambient humidity	10...90 % RH (non-condensing)
Media temperature	-40...+120 °C
Storage temperature	-40...+85 °C
Storage humidity	< 95 % RH
Connection	Standard R1" (DIN 2999) for series SF1 and SF2
Material, casing cover	Transparent Polycarbonate (PC)
Material, casing base	ABS
Paddles	Stainless steel AISI 316L
Weight	950 g
Dimensions	140 x 62 x 65 mm
Protection class	IP65
Isolation class	I



SF2EI



SF3E



FLZ-09

Article	For pipes (diameter)	Flow	Media	"T" pipe fitting	Max. pressure
SF1K	1...8"	0.6...90.8 m <sup>3</sup> /h	Normal (body in brass)	-	1100 kPa (11 bar)
SF1E	1...8"	0.6...90.8 m <sup>3</sup> /h	Normal (body in brass)	-	1100 kPa (11 bar)
SF1RE	1...8"	0.2...55.3 m <sup>3</sup> /h	Normal (body in brass)	-	1100 kPa (11 bar)
SF2EI	1...8"	0.6...90.8 m <sup>3</sup> /h	Corrosive (AISI 316L compatibility)	-	3000 kPa (30 bar)
SF2REI	1...8"	0.2...55.3 m <sup>3</sup> /h	Corrosive (AISI 316L compatibility)	-	3000 kPa (30 bar)
SF3E	1/2"	0.174...0.846 m <sup>3</sup> /h	Normal (body in brass)	X	1100 kPa (11 bar)
SF4E	3/4"	0.138...0.768 m <sup>3</sup> /h	Normal (body in brass)	X	1100 kPa (11 bar)
SF6E	1"	0.2...1.0 m <sup>3</sup> /h	Normal (body in brass)	X	1100 kPa (11 bar)

### ACCESSORIES

Article	Description
DBZ-09	Paddles for liquid flow switch in stainless steel AISI 316L. (Only for FLS304... and FLS350... Not for FLS306X, FLS307X or FLS308X.)



Models SF1E and SF2EI with TÜV approval.

Notes: the flow switches are supplied with paddles model DBZ-09.

On request available: 1" NPT connection version (product code "SFxx/NPT") for SF1 and SF2 series.

## SF1K/SF1E/SF2EI Flow chart H<sub>2</sub>O

Pipe connector Ø	Qmax m <sup>3</sup> /h recommended	Min. adjustment m <sup>3</sup> /h cut-off cut-in	Max. adjustment m <sup>3</sup> /h cut-off cut-in
1"	3,6	0,6 (1,0)	2,0 (2,1)
1 1/4"	6,0	0,8 (1,3)	2,8 (3,0)
1 1/2"	9,0	1,1 (1,7)	3,7 (4,0)
2"	15,0	2,2 (3,1)	5,7 (6,1)
2 1/2"	24,0	2,7 (4,0)	6,5 (7,0)
3"	36,0	4,3 (6,2)	10,7 (11,4)
4"	60,0	11,4 (14,7)	27,7 (29,0)
4" Z	60,0	6,1 (8,0)	17,3 (18,4)
5"	94,0	22,9 (28,4)	53,3 (55,6)
5" Z	94,0	9,3 (12,9)	25,2 (26,8)
6"	120,0	35,9 (43,1)	81,7 (85,1)
6" Z	120,0	12,3 (16,8)	30,6 (32,7)
8"	240,0	72,6 (85,1)	165,7 (172,5)
8" Z	240,0	38,6 (46,5)	90,8 (94,2)

For models with suffix "Z" the longest paddle must be used to obtain the values indicated on the table.

Pressure drop at the maximum flow (Qmax): 0,08 bar

**Nota:** the values indicated on schedule have been measured with the flow switch mounted on horizontal position.

## SF1RE/SF2REI Flow chart H<sub>2</sub>O

Pipe connector Ø	Min. adjustment m <sup>3</sup> /h cut-off cut-in	Max. adjustment m <sup>3</sup> /h cut-off cut-in
1"	0,2 (0,6)	1,0 (1,1)
1 1/4"	0,25 (0,9)	1,4 (1,6)
1 1/2"	0,5 (1,2)	1,6 (2,2)
2"	0,9 (2,3)	3,6 (4,1)
2 1/2"	1,2 (3,1)	4,9 (5,5)
3"	2,1 (4,9)	7,4 (8,2)
4"	4,9 (11,3)	17,1 (19,1)
4" Z	3,3 (7,7)	11,6 (13,0)
5"	9,7 (22,4)	34,0 (37,9)
5" Z	5,0 (11,5)	17,5 (19,6)
6"	13,6 (31,5)	47,6 (53,2)
6" Z	6,1 (14,1)	21,4 (23,9)
8"	25,7 (59,6)	90,1 (100,7)
8" Z	21,7 (36,5)	55,3 (61,8)

**Nota:** the values indicated on schedule have been measured with the flow switch mounted on horizontal position.

**Palette** (models without "T" pipe fitting)

## SF3E/4E/6E

### Flow chart with „T“ fittings

SF-	Pipe connector with "T" pipe fitting Ø	Min. adjustment m <sup>3</sup> /h cut-off cut-in	Max. adjustment m <sup>3</sup> /h cut-off cut-in
3E	1/2"	0,174 (0,48)	0,846 (0,948)
4E	3/4"	0,138 (0,408)	0,768 (0,858)
6E	1"	0,2 (0,6)	1,0 (1,1)

The "T" connectors have cylindrical GAS thread.

**Nota:** the values indicated on schedule have been measured with the flow switch mounted on horizontal position.

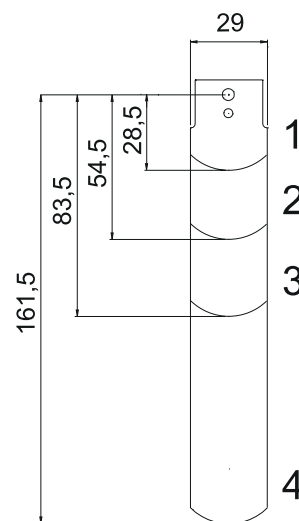

PIPE	PADDLES
1"	1
1 1/4"	1
1 1/2"	1
2"	1+2
2 1/2"	1+2
3"	1+2+3
4"	1+2+3
4" Z	1+2+3+4
5"	1+2+3
5" Z	1+2+3+4
6"	1+2+3
6" Z	1+2+3+4
8"	1+2+3
8" Z	1+2+3+4



## AIR FLOW SWITCH

Air or non-aggressive gas flow control. Alarm signal for flow shortage. Well-suited for air ducts, air conditioning and air handling systems.



SL1E

Technical data	
Contacts	Dust-tight microswitch with SPDT contacts (NC/NO)
Switch capacity	15 (8) A, 24...250 V AC
Ambient temperature	-40...+85 °C
Ambient humidity	10...90 % RH (non-condensing)
Media temperature	-10...+85 °C
Storage temperature	-40...+85 °C
Storage humidity	< 95 % RH
Material, casing cover	Transparent PC
Material, casing base	ABS
Body	Brass
Paddles	Stainless steel AISI 301
Weight	630 g
Dimensions	265.5 x 140 x 102 mm
Protection class	IP65

Article	Cut out	Cut in	Max. air temperature
SL1E	min. 1.0 m/s - max. 8.0 m/s	min. 2.5 m/s - max. 9.2 m/s	85 °C

## ACCESSORIES

Article	Description
DBZ-08	Stainless steel AISI 301 paddle for air flow switch



DBZ-08



*Supplied with paddel model DBZ-08.*

*The values indicated on schedule have been measured with the flow switch mounted on horizontal position.*



# Pressure switches and transmitters

## AIR DIFFERENTIAL PRESSURE SWITCHES

Differential pressure for air or non-aggressive and non-inflammable gas control.



DBL

Technical data	
Contacts	Microswitch with SPDT contacts, according to EN 1854 (EN 60730)
Switch capacity	1.5 (0.4) A, 250 V AC
Ambient temperature	-20...+85 °C
Ambient humidity	10...90 % RH (non-condensing)
Storage temperature	-40...+85 °C
Max. pressure	100 mbar
Diaphragm	Silicone (LSR)
Casing	Polystyrene
Weight	180...210 g
Dimensions	Ø 118 x h 57.5 mm
Protection class	IP54
Isolation class	II

Article	Range	Hysteresis
DBL-205A	0.3...4.0 mbar (30...400 Pa)	0.15 mbar ± 15%
DBL-205B	0.5...5.0 mbar (50...500 Pa)	0.2 mbar ± 15%
DBL-205C	0.2...3.0 mbar (20...300 Pa)	0.1 mbar ± 15%
DBL-205D	2...10 mbar (200...1000Pa)	1.0 mbar ± 15%
DBL-205E	5...25 mbar (500...2500 Pa)	1.5 mbar ± 15%

## ACCESSORIES

Article	Description
DBZ-06	Connection set with 2 PVC duct connectors, 2 m flexible PVC pipe and 4 screw
DBZ-14A	Set with mounting bracket and screws (S-shaped)
DBZ-14B	Set with mounting bracket and screws (L-shaped)



Articles available in multipack /M: DBL-205.../M (45 pcs.)



DBZ-06



DBZ-14A



DBZ-14B

## MANOMETERS AND AIR DIFFERENTIAL PRESSURE SWITCHES

Differential pressure visualization of air or non-aggressive and non-inflammable gases with alarm at a pre-set value.



DB-M6P6

The compact unit consists of:

- a differential manometer with an inclined liquid pipe, complete of tank to allow temporary overpressure;
- a bottle containing indication liquid and 2 stickers (red/green);
- a differential pressure switch connected to the manometer with PVC hose, complete of pressure adjustment knob, terminals for electrical connections and cable gland PG 9 (protection class according to EN 60529: IP54);
- PVC hose  $\varnothing 4 \times 7$  - 2.2 m length, pipes and fixing screws.

Technical data	
Contacts	Dust-tight microswitch with SPDT contacts
Switch capacity	3 (2) A, 250 V AC
Ambient temperature	-40...+60 °C
Ambient humidity	10...90 % RH (non-condensing)
Storage temperature	DB-M...: -45...+70 °C DB-M...P...: -25...+70 °C
Accuracy	5 Pa
Fluid	ISO-paraffin with density at 15 °C DB-M6P6: red colour DB-M10P13: blue colour
Electrical connection	With terminals and cable gland PG9
Material	ABS, PMMA, PC
Packing	NBR
Weight	400...820 g
Dimensions	290 x 140 x 64 mm
Protection class	IP54 class II
Isolation class	II

Article	Manometer range	Pressure switch range	Hysteresis	Max. pressure
DB-M6	0...600 Pa	-	-	200 kPa
DB-M6P6	0...600 Pa	40...600 Pa	30 Pa	50 kPa
DB-M10	0...1500 Pa	-	-	200 kPa
DB-M10P13	0...1500 Pa	100...1300 Pa	80 Pa	50 kPa

## DIFFERENTIAL PRESSURE TRANSMITTERS 0...1 BAR

Differential pressure transmitter for monitoring differential gaseous pressure, non-aggressive media. Can be mounted in any position.

Possible areas of applications are:

- air-conditioning and clean rooms;
- building automation;
- valve and flap control;
- fluid and level monitoring;
- control of air flows.



984M.3X3104



984M.343714

Technical data	
Supply voltage	24 V AC / DC with output 0...10 V DC and 4...20 mA 24 V DC with output 4...20 mA (2 wires)
Outputs	0...10 V DC (max 10 mA) 4...20 mA (20...500 Ohm)
Sensor	Piezoresistive
Ambient temperature	0...50 °C
Ambient humidity	10...95 % RH (non-condensing)
Storage temperature	-10...+70 °C
Accuracy	< ± 0.2 % of end of scale
Typical long term stability	< ± 0.5 % to ± 2.5 % of end of scale/year
Response time	100 ms or 1 sec., selectable
Installation	Can be mounted in any position
Casing	Housing with process connection P2 made of ABS, mounting part with process connection P1 made of POM
Weight	170 g
Dimensions	Max. Ø 118 x h 57.5 mm
Protection class	IP54
Certification	EN60770, EN61326

### 984M.3

X 3 X X 4

#### Pressure range (Pa):

Range 1	Range 2	overload max	
0...100 Pa (1.0 mbar)	0...250 Pa (2.5 mbar)	60 kPa	2
0...250 Pa (2.5 mbar)	0...500 Pa (5.0 mbar)	60 kPa	3
0...500 Pa (5.0 mbar)	0...1.000 Pa (10 mbar)	75 kPa	4
0...1 kPa (10 mbar)	0...2.5 kPa (25 mbar)	85 kPa	5
0...5 kPa (50 mbar)	0...10 kPa (100 mbar)	85 kPa	7
0...25 kPa (250 mbar)	0...50 kPa (500 mbar)	200 kPa	9
0...50 kPa (500 mbar)	0...100 kPa (1000 mbar)	200 kPa	A
-50...+50 Pa (-0,5...+0,5 mbar)		60 kPa	X
-100...+100 Pa (-1,0...+1,0 mbar)		60 kPa	W

Pressure unit Pascal

#### Output and power supply

0...10 Vdc	24 Vac/dc, with open collector NPN output, 3-wire cable	1
4...20 mA	24 Vdc, without open collector NPN output, 2-wire cable	2
4...20 mA	24 Vac/dc, with open collector NPN output, 3-wire cable	3
0...10 Vdc	24 Vac/dc, without open collector NPN output, 3-wire cable	7
4...20 mA	24 Vac/dc, without open collector NPN output, 3-wire cable	D

#### Display

None	0
With LED-display, 3.5 digits (not for output 4...20 mA, 2-wire)	1

#### Electrical connections

Screw terminal block

### ACCESSORIES

Article	Description
DBZ-06	Connection set with 2 PVC duct connectors, 2 m flexible PVC pipe and 4 screw
DBZ-14A	Set with mounting bracket and screws (S-shaped)
DBZ-14B	Set with mounting bracket and screws (L-shaped)
104552	Test certificate



DBZ-06



DBZ-14A



DBZ-14B

## DIFFERENTIAL PRESSURE TRANSMITTER WITH DISPLAY

Differential pressure transmitter for use in air and non-corrosive gases. For control of dampers, frequency converters, VAV systems etc.



TPDA

### Technical data

Supply voltage	24 V AC/DC (21...27 V AC/DC)
Output signal, pressure	0...10 V DC / 4...20 mA
Measuring range, pressure	0...100 / 0...300 / 0...500 / 0...999 Pa
Accuracy, pressure	±1 % full scale at 20 °C
Electronic damping	0...20 s
Display	Yes
Dimensions, external (WxHxD)	89 x 129 x 58 mm
Protection class	IP54

### MODELS WITH CONNECTION KIT (MTU) AND 2M PLASTIC TUBE

Article	Description
TPDA	Differential pressure transmitter

## DIFFERENTIAL PRESSURE TRANSMITTER WITH BUILT-IN CONTROLLER AND DISPLAY

Differential pressure transmitter for use in air and non-corrosive gases. For control of dampers, frequency converters, VAV systems etc.



TPDA-C

### Technical data

Supply voltage	24 V AC/DC (21...27 V AC/DC 50-60 Hz)
Output signal, pressure	0...10 V DC / 4...20 mA
Output signal, controller	0...10 V DC
Measuring range, pressure	0...100 / 0...300 / 0...500 / 0...999 Pa
Accuracy, pressure	±1 % full scale at 20 °C
P-band	0...300 %
I-time	0...999 s
D-factor	0...999
Electronic damping	0...20 s
Display type	LED, three digits
Mounting	Wall
Dimensions, external (WxHxD)	89 x 129 x 58 mm
Protection class	IP54

### MODELS WITH CONNECTION KIT (MTU) AND 2M PLASTIC TUBE

Article	Description
TPDA-C	Differential pressure transmitter

## DIFFERENTIAL PRESSURE TRANSMITTERS WITH COMMUNICATION



TPDA-12CX

Technical data	
Supply voltage	24 V AC/DC (21...27 V AC/DC)
Protection class	IP54
Power consumption	< 1 VA
Ambient temperature	-25...+50 °C
Mounting	Wall
Accuracy, pressure	≤ 1 % full scale
Accessories, included	Two pressure outlets (straight) and 2 m plastic tube. Art. no.: ANS-20
Pressure data	
Media	Air, non-combustible and non-aggressive gases
Response time	40 ms, depending on filtertime
Sensor element, pressure	Piezoresistive
Temperature dependency, pressure	Thermal effects: 1 (-25...+85 °C), Offset: ±0.5 % FSS, Span: ±1.0 % FSS
Accuracy, pressure	≤ 1 % full scale
Resolution	0,005 % of full scale
Warmup time	< 5 min
Annual deviation	±2 Pa (1250 Pa) ±4 Pa (2500 Pa) ±20 Pa (7500 Pa)
K-factor	5 (5...700)
Zero-point adjustment	By pressing a button, the output signal and the display adjusts to zero.
Universal inputs (UI1, UI2)	
Accuracy	± 1 % (0...10 V) ± 0.5 K (PT1000/Ni1000-01)
Digital inputs (DI)	Potential-free contacts on/off (closed=on)
Universal output (UO1, UO2)	
Analogue outputs (AO)	0...10 V
Accuracy	± 1 %
Digital outputs (DO)	Potential-free contacts on / off (on = closed)
Power output	Max. 2A (total UO1 + UO2)
Communication data	
Supported protocols	
Material, housing	Polycarbonate (PC)
Material, base	Polycarbonate (PC)

### MODELS WITH CONNECTION KIT (ANS-20)

Article	Number of sensors	Max. overload pressure	Measuring range, pressure
TPDA-12CX	1	25 kPa	0...1250 Pa
TPDA-25CX	1	50 kPa	0...2500 Pa
TPDA-75CX	1	120 kPa	0...7500 Pa
TPDA-12CX2	2	25 / 25 kPa	0...1250 Pa (sensor 1) / 0...1250 Pa (sensor 2)
TPDA-25CX2C	2	50 / 50 kPa	0...2500 Pa (sensor 1) / 0...2500 Pa (sensor 2)
TPDA-12CXS25C	2	25 / 50 kPa	0...1250 Pa (sensor 1) / 0...2500 Pa (sensor 2)
TPDA-12CXS75C	2	25 / 120 kPa	0...1250 Pa (sensor 1) / 0...7500 Pa (sensor 2)

### ACCESSORIES

Article	Description
ANS-3	2 m plastic tube and two pressure outlets (metal, 90° angle)
ANS-20	2 m plastic tube and two pressure outlets (straight)

## DIFFERENTIAL PRESSURE TRANSMITTERS WITH ANALOGUE OUTPUTS



TPDAxxxAx

### Technical data

Supply voltage	24 V AC/DC ±15 %
Overall accuracy pressure	≤ 1 % full scale
Power consumption	0...10 V mode : 2 VA (rms), min. trafo size 7,5 VA 4...20 mA mode : 2.7 VA (rms), min. trafo size 9 VA
Operating temperature	-25...+50 °C
Protection class	IP54
Accessories, included	Two pressure outlets (straight) and 2 m plastic tube. Art. no.: ANS-20

Article	Working range	Number of sensors
TPDA12A	0...1250 Pa	1
TPDA25A	0...2500 Pa	1
TPDA75A	0...7500 Pa	1
TPDA1225A2	PS1: 0...1250 Pa / PS2: 0...2500 Pa	2
TPDA1275A2	PS1: 0...1250 Pa / PS2: 0...7500 Pa	2

## PRESSURE TRANSMITTER FOR LIQUIDS AND GASES

Pressure transmitter for measurement of liquids and gases.



### Technical data

Output signal	0...10 V DC (three-wire) or 4...20 mA (two-wire)
Pressure connection	G 1/4" (outside thread)
Dynamic response time	< 2 ms, 1 ms typically
Tolerable overload	≤ 4 bar 3.0 x full scale, > 4 bar 2.5 x full scale
Media temperature	-15...+125 °C
Ambient temperature	-30...+85 °C
Storage temperature	-50...+100 °C
Accuracy, characteristic line	±0.3 % full scale *
Accuracy, resolution	0.1 % full scale *
Accuracy, thermal characteristic	Max. ±0.2 % full scale / 10 K *
Accuracy, long-term stability according to IEC EN 60770-1	Max. ±0.25 % full scale *
Sealing	FPM
Weight	90 g
Cable length	1.5 m
Protection class	IP67

### MODELS

Article	Working range	Output signal	Supply voltage	Power consumption
TPGL1	0...100 kPa (1 bar)	0...10 V DC	12...33 V DC / 24 V AC ±15 %	< 7 mA
TPGL1-420	0...100 kPa (1 bar)	4...20 mA	7...33 V DC	< 23 mA
TPGL2.5	0...250 kPa (2.5 bar)	0...10 V DC	12...33 V DC / 24 V AC ±15 %	< 7 mA
TPGL2.5-420	0...250 kPa (2.5 bar)	4...20 mA	7...33 V DC	< 23 mA
TPGL6	0...600 kPa (6 bar)	0...10 V DC	12...33 V DC / 24 V AC ±15 %	< 7 mA
TPGL6-420	0...600 kPa (6 bar)	4...20 mA	7...33 V DC	< 23 mA
TPGL10	0...1000 kPa (10 bar)	0...10 V DC	12...33 V DC / 24 V AC ±15 %	< 7 mA
TPGL10-420	0...1000 kPa (10 bar)	4...20 mA	7...33 V DC	< 23 mA
TPGL16	0...1600 kPa (16 bar)	0...10 V DC	12...33 V DC / 24 V AC ±15 %	< 7 mA
TPGL16-420	0...1600 kPa (16 bar)	4...20 mA	7...33 V DC	< 23 mA
TPGL25	0...2500 kPa (25 bar)	0...10 V DC	12...33 V DC / 24 V AC ±15 %	< 7 mA
TPGL25-420	0...2500 kPa (25 bar)	4...20 mA	7...33 V DC	< 23 mA
TPGL40	0...4000 kPa (40 bar)	0...10 V DC	12...33 V DC / 24 V AC ±15 %	< 7 mA
TPGL40-420	0...4000 kPa (40 bar)	4...20 mA	7...33 V DC	< 23 mA

## ACCESSORIES

Article	Description
TPL105074	Mounting spacer which lowers the temperature at higher media temperatures than the sensor can handle.
DBZ-AD1	Adapter 1/4" to 1/2". For mounting immersion sensors in 1/2".



For other models please contact Industrietechnik.



TPL105074



DBZ-AD1

## DIFFERENTIAL PRESSURE TRANSMITTER FOR LIQUIDS AND GASES

Differential pressure transmitter for measurement of liquids (also glycol-mixed) and gases (not ammonia).

Supply voltage	24 V CA / 18...33 V DC $\pm$ 15% (output signal 0...10 V), 0.1 VA 11...33 V DC $\pm$ 15%, two-wire (output signal 4...20 mA), 0.5 VA
Output signal	0...10 V DC or 4...20 mA (two-wire)
Ambient temperature	-15...+85 °C
Accuracy	TPDL10...TPDL250: $\pm$ 1.3 % es TPDL400: $\pm$ 0.8 % es TPDL600...TPDL2500: $\pm$ 0.5 % es
Connection	Screw fitting for $\varnothing$ 6 mm pipe included
Electrical connection	DIN EN 175301 803-A
Dimensions	68 x 40 x 113 mm
Protection class	IP65



TPDL

Article	Output signal	Working range
TPDL10	0...10 V DC	0...10 kPa (0...0.1 bar)
TPDL10-420	4...20 mA	0...10 kPa (0...0.1 bar)
TPDL20	0...10 V DC	0...20 kPa (0...0.2 bar)
TPDL20-420	4...20 mA	0...20 kPa (0...0.2 bar)
TPDL40	0...10 V DC	0...40 kPa (0...0.4 bar)
TPDL40-420	4...20 mA	0...40 kPa (0...0.4 bar)
TPDL100	0...10 V DC	0...100 kPa (0...1 bar)
TPDL100-420	4...20 mA	0...100 kPa (0...1 bar)
TPDL250	0...10 V DC	0...250 kPa (0...2.5 bar)
TPDL250-420	4...20 mA	0...250 kPa (0...2.5 bar)
TPDL400	0...10 V DC	0...400 kPa (0...4 bar)
TPDL400-420	4...20 mA	0...400 kPa (0...4 bar)
TPDL600	0...10 V DC	0...600 kPa (0...6 bar)
TPDL600-420	4...20 mA	0...600 kPa (0...6 bar)
TPDL1000	0...10 V DC	0...1000 kPa (0...10 bar)
TPDL1000-420	4...20 mA	0...1000 kPa (0...10 bar)
TPDL1600	0...10 V DC	0...1600 kPa (0...16 bar)
TPDL1600-420	4...20 mA	0...1600 kPa (0...16 bar)
TPDL2500	0...10 V DC	0...2500 kPa (0...25 bar)
TPDL2500-420	4...20 mA	0...2500 kPa (0...25 bar)

Article	Description
TPDL-NIPPEL	Nipple (R=1/8" 27 NPT) for connection of $\varnothing$ 6 mm copper pipe
TPDL-R	Copper pipe, $\varnothing$ 6 mm, length 30 cm



TPDL-NIPPEL



TPDL-R



For other models please contact Industrietechnik.



# Level switches

## LEVEL SWITCH

Level control of normal liquids contained in tanks and barrels.

Alarm signal of minimum or maximum level.



SQ01

### Technical data

Contacts	Microswitch with SPDT contacts
Switch capacity	15 (8) A, 24...250 V AC
Ambient temperature	-40...+85 °C
Ambient humidity	10...90 % RH (non-condensing)
Media temperature	max. +85 °C
Storage temperature	-40...+85 °C
Storage humidity	< 95 % RH
Level length	200 mm
Protection class	IP65
Isolation class	I

### Material

Material, casing cover	Transparent polycarbonate
Material, casing base	ABS
Body	Brass
Float	Acrylic
Weight	960 g
Dimensions	140 x 62 x 65 mm

Article	Hysteresis	Max. temperature	Max. pressure
SQ01	10/14 mm	+85 °C	11 bar

# 6 Wireless products

---

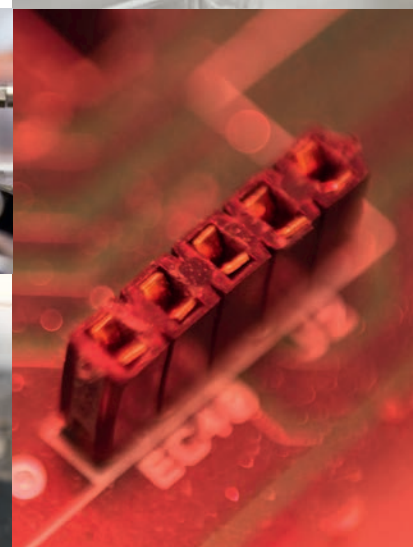

## WIRELESS RECEIVER WITH MODBUS COMMUNICATION

MR32W is a Modbus receiver that can pair with up to 32 wireless sensors and detectors. It monitors the sensors and reports the information to the user via Modbus communication.



MR32W

### Technical data

Supply voltage	24 V AC/DC (21...27 V AC/DC)
Frequency	868 MHz
Protection class	IP54
Ambient temperature	-10...+50 °C
Ambient humidity	Max. 85 % RH, non-condensing
Dimensions, external (WxHxD)	120 x 112 x 40 mm

### Article

### Description

MR32W	Wireless 32 channel receiver with Modbus communication
-------	--

## WIRELESS ROOM TEMPERATURE AND HUMIDITY SENSOR

High quality room temperature and humidity sensor within.



SAUW

### Technical data

Power supply	AA 1.5 V L91 battery x 2
Frequency	868 MHz
Protection class	IP30
Measuring range, temperature	-10...+50 °C
Measuring range, humidity	0...100 % RH
Dimensions, external (WxHxD)	86 x 86 x 30 mm

### Article

### Description

SAUW	Wireless room temperature and humidity sensor
------	---

## WIRELESS OUTDOOR TEMPERATURE SENSOR

Sensor for outdoor temperature measurement.



SEW-PT1000

### Technical data

Power supply	CR123A 3V lithium battery x 2
Frequency	868 MHz
Protection class	IP54
Ambient temperature	-40...+50 °C
Ambient humidity	up to 95 % RH non-condensing

### Article

### Description

SEW	Wireless outdoor temperature sensor
SEW-PT1000	Wireless outdoor temperature sensor equipped with a terminal for connecting an external PT1000 sensor

## WIRELESS CEILING MOUNTED MOTION DETECTOR

SIR-SW is a high quality ceiling mounted motion detector. The detector maintains a stable and highly sensitive level of detection regardless of changes in the environment. It has a communication range of up to 300 meters in open space.



SIR-SW

Technical data	
Supply voltage	CR123A 3V lithium battery x 1 (CR123A)
Frequency	868 MHz
Protection class	IP20
Ambient temperature	-10...+45 °C
Ambient humidity	Max. 85 % RH (non-condensing)

Article	Description
SIR-SW	Wireless ceiling mounted IR motion detector

## WIRELESS MOTION DETECTOR

SIR-PW is a high quality IR motion detector. The detector maintains a stable and highly sensitive level of detection regardless of changes in the environment. It has a communication range of up to 300 meters in open space.



SIR-PW

Technical data	
Supply voltage	CR123A 3V lithium battery, 1500 mAh x 1 (pre-installed)
Frequency	868 MHz
Protection class	IP20
Ambient temperature	-10...+50 °C
Ambient humidity	Max. 85 % RH (non-condensing)

Article	Description
SIR-PW	Wireless motion detector

## WIRELESS DIGITAL INPUT/DOOR CONTACT

CFW is a digital input/door contact detecting opening of door or window.



CFW

Technical data	
Power supply	CR2 3V lithium battery
Frequency	868 MHz
Protection class	IP30
Ambient temperature	-10...+50 °C
Ambient humidity	Max. 85 % RH (non-condensing)

Article	Description
CFW	Wireless digital input / door contact



# 7 Damper actuators

---

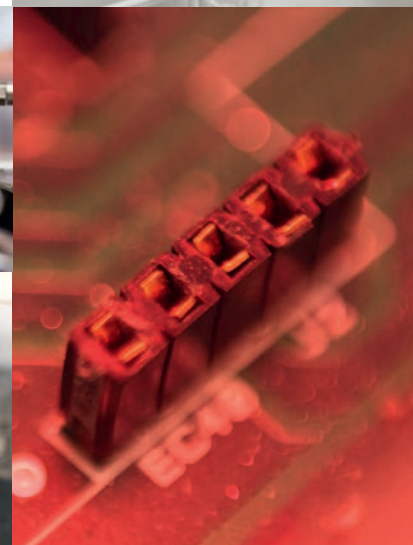
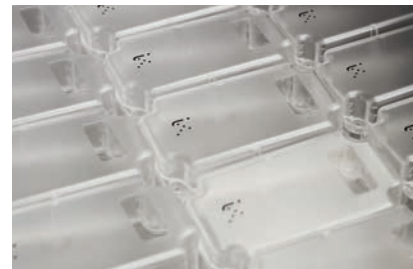

## DAMPER ACTUATORS WITHOUT SPRING RETURN, 2 NM

Designed for applications with small dampers (0.5 m<sup>2</sup>) of ventilation and air handling units.



DAK-DMK

Technical data	
Max. damper size	0.5 m <sup>2</sup>
Torque	2 Nm
Frequency	50...60 Hz
Rotation angle	95°
Ambient temperature	-20...+50 °C
Ambient humidity	5...95% UR
Noise level	Max 45 dB
Mounting	Directly on jack shaft
For jack shaft	6...16 mm Ø (round shaft), 5...11 mm (square shaft)
Weight	600 g
Protection class	IP54
Isolation class	III (DAK230: class II)
Certification	CE

Article	Supply voltage	Control signal	Power consumption	Auxiliary switch	Stroke time
DAK24	24 V AC / DC	On/off or 3 point	2,0 W	-	35...45 s
DAK24S	24 V AC / DC	On/off or 3 point	2.0 W	1 fixed SPDT 3 (1.5) A / AC 230 V positioned on 10°	35...45 s
DAK230	230 V AC	On/off or 3 point	1,5 W	-	35...45 s
DAK230S	230 V AC	On/off or 3 point	1.5 W	1 fixed SPDT 3 (1.5) A / AC 230 V positioned on 10°	35...45 s
DMK24	24 V AC / DC	2...10 V DC	2,5 W	-	45...55 s

## DAMPER ACTUATORS WITHOUT SPRING RETURN, 4 NM

Well-suited for applications with small dampers (up to 1 m<sup>2</sup>) in ventilation and air handling units.



DAN-DMN

Technical data	
Max. damper size	1 m <sup>2</sup>
Torque	4 Nm
Frequency	50...60 Hz
Stroke time	35 s
Rotation angle	90°. Limitation: 5...85° in 5° steps
Ambient temperature	-20...+50 °C
Ambient humidity	5...95 % RH
Noise level	Max 45 dB
Mounting	Directly on jack shaft
For jack shaft	10...16 mm Ø (round shaft), 10...12 mm (square shaft)
Protection class	IP44 or IP54 with cable glands
Isolation class	III (DAN230: class II)
Certification	CE

Article	Supply voltage	Control signal	Power consumption	Auxiliary switch	Weight
DAN24	24 V AC / DC	On/off or 3 point	Operating: 2.5 W Maintenance: 0.85 W	-	900 g
DAN24S	24 V AC / DC	On/off or 3 point	Operating: 2.5 W Maintenance: 0.85 W	2 x 3 (1.5) A / AC 230 V	900 g
DAN230	230 V AC	On/off or 3 point	Operating: 4.0 W Maintenance: 3.0 W	-	1000 g
DAN230S	230 V AC	On/off or 3 point	Operating: 4.0 W Maintenance: 3.0 W	2 x 3 (1.5) A / AC 230 V	1000 g
DMN24	24 V AC / DC	0...10 V DC	Operating: 2.5 W Maintenance: 0.85 W	-	900 g

## DAMPER ACTUATORS WITHOUT SPRING RETURN, 8 NM

Well-suited for applications with dampers (2 m<sup>2</sup>) in ventilation and air handling units.



DAS-DMS

Technical data	
Max. damper size	2 m <sup>2</sup>
Torque	8 Nm
Frequency	50...60 Hz
Stroke time	30 s
Rotation angle	Operating: 90° (93° mechanical) Limitation: 5...85° in 5° steps
Ambient temperature	-20...+50 °C
Ambient humidity	5...95 % RH
Noise level	Max 45 dB
Mounting	Directly on jack shaft
For jack shaft	10...20 mm Ø (round shaft), 10...20 mm (square shaft)
Weight	1200 g
Protection class	IP44 or IP54 with cable glands
Isolation class	III (DAS230, DMS230: class II)
Certification	CE

Article	Supply voltage	Control signal	Power consumption	Auxiliary switch
DAS24	24 V AC / DC	on/off or 3 point	Operating: 3.9 W Maintenance: 0.4 W	-
DAS24S	24 V AC / DC	on/off or 3 point	Operating: 3.9 W Maintenance: 0.4 W	2 x 3 (1.5) A / AC 230 V
DAS230	230 V AC	on/off or 3 point	Operating: 4.8 W Maintenance: 1.2 W	-
DAS230S	230 V AC	on/off or 3 point	Operating: 4.8 W Maintenance: 1.2 W	2 x 3 (1.5) A / AC 230 V
DMS24	24 V AC / DC	Y1: 0(2)...10 V DC Y2: 0(4)...20 mA U: 0(2)...10 V DC (feedback signal)	Operating: 4.0 W Maintenance: 0.7 W	-
DMS24S	24 V AC / DC	Y1: 0(2)...10 V DC Y2: 0(4)...20 mA U: 0(2)...10 V DC (feedback signal)	Operating: 4.0 W Maintenance: 0.7 W	2 x 3 (1.5) A / AC 230 V
DMS230	230 V AC	Y1: 0(2)...10 V DC Y2: - U: 0(2)...10 V DC (feedback signal)	Operating: 4.8 W Maintenance: 1.0 W	-
DMS230S	230 V AC	Y1: 0(2)...10 V DC Y2: - U: 0(2)...10 V DC (feedback signal)	Operating: 4.8 W Maintenance: 1.0 W	2 x 3 (1.5) A / AC 230 V



## DAMPER ACTUATORS WITHOUT SPRING RETURN, 16 NM

Well-suited for applications with dampers (4 m<sup>2</sup>) in ventilation and air handling units.



DA-DM

Technical data	
Max. damper size	4 m <sup>2</sup>
Torque	16 Nm
Frequency	50...60 Hz
Stroke time	80 s
Rotation angle	90° Limitation: 5...85° in 5° steps
Ambient temperature	-20...+50 °C
Ambient humidity	5...95 % RH
Noise level	Max 45 dB
Mounting	Directly on jack shaft
For jack shaft	10...20 mm Ø (round shaft), 10...20 mm (square shaft)
Weight	1200 g
Protection class	IP44 or IP54 with cable glands
Isolation class	III (DA230, DM230: class II)
Certification	CE

Article	Supply voltage	Control signal	Power consumption	Auxiliary switch
DA24	24 V AC / DC	on/off or 3 point	Operating: 3.9 W Maintenance: 0.4 W	-
DA24S	24 V AC / DC	on/off or 3 point	Operating: 3.9 W Maintenance: 0.4 W	2 x 3 (1.5) A / AC 230 V
DA230	230 V AC	on/off or 3 point	Operating: 4.8 W Maintenance: 1.2 W	-
DA230S	230 V AC	on/off or 3 point	Operating: 4.8 W Maintenance: 1.2 W	2 x 3 (1.5) A / AC 230 V
DM24	24 V AC / DC	Y1: 0(2)...10 V DC Y2: 0(4)...20 mA U: 0(2)...10 V DC (feedback signal)	Operating: 4.0 W Maintenance: 0.7 W	-
DM24S	24 V AC / DC	Y1: 0(2)...10 V DC Y2: 0(4)...20 mA U: 0(2)...10 V DC (feedback signal)	Operating: 4.0 W Maintenance: 0.7 W	2 x 3 (1.5) A / AC 230 V
DM230	230 V AC	Y1: 0(2)...10 V DC Y2: - U: 0(2)...10 V DC (feedback signal)	Operating: 4.8 W Maintenance: 1.0 W	-
DM230S	230 V AC	Y1: 0(2)...10 V DC Y2: - U: 0(2)...10 V DC (feedback signal)	Operating: 4.8 W Maintenance: 1.0 W	2 x 3 (1.5) A / AC 230 V

## DAMPER ACTUATORS WITHOUT SPRING RETURN, 24 NM

Well-suited for applications with dampers (6 m<sup>2</sup>) in ventilation and air handling units.



DAL-DML

Technical data	
Max. damper size	6 m <sup>2</sup>
Torque	24 Nm
Frequency	50...60 Hz
Stroke time	125 s
Rotation angle	90° Limitation: 5...85° in 5° steps
Ambient temperature	-20...+50 °C
Ambient humidity	5...95 % RH
Noise level	Max 45 dB
Mounting	Directly on jack shaft
For jack shaft	10...20 mm Ø (round shaft), 10...20 mm (square shaft)
Weight	1200 g
Protection class	IP44 or IP54 with cable glands
Isolation class	III (DAL230, DML230: class II)
Certification	CE

Article	Supply voltage	Control signal	Power consumption	Auxiliary switch
DAL24	24 V AC / DC	on/off or 3 point	Operating: 3.9 W Maintenance: 0.4 W	-
DAL24S	24 V AC / DC	on/off or 3 point	Operating: 3.9 W Maintenance: 0.4 W	2 x 3 (1.5) A / AC 230 V
DAL230	230 V AC	on/off or 3 point	Operating: 4.8 W Maintenance: 1.2 W	-
DAL230S	230 V AC	on/off or 3 point	Operating: 4.8 W Maintenance: 1.2 W	2 x 3 (1.5) A / AC 230 V
DML24	24 V AC / DC	Y1: 0(2)...10 V DC Y2: 0(4)...20 mA U: 0(2)...10 V DC (feedback signal)	Operating: 4.0 W Maintenance: 0.7 W	-
DML24S	24 V AC / DC	Y1: 0(2)...10 V DC Y2: 0(4)...20 mA U: 0(2)...10 V DC (feedback signal)	Operating: 4.0 W Maintenance: 0.7 W	2 x 3 (1.5) A / AC 230 V
DML230	230 V AC	Y1: 0(2)...10 V DC Y2: - U: 0(2)...10 V DC (feedback signal)	Operating: 4.8 W Maintenance: 1.0 W	-
DML230S	230 V AC	Y1: 0(2)...10 V DC Y2: - U: 0(2)...10 V DC (feedback signal)	Operating: 4.8 W Maintenance: 1.0 W	2 x 3 (1.5) A / AC 230 V

## DAMPER ACTUATORS WITHOUT SPRING RETURN, 32 NM

Well-suited for applications with medium or large dampers (8 m<sup>2</sup>) in ventilation and air handling units.



DAG-DMG

Technical data	
Max. damper size	8 m <sup>2</sup>
Torque	32 Nm
Frequency	50...60 Hz
Rotation angle	90° Limitation: 5...85° in 5° steps
Ambient temperature	-20...+50 °C
Ambient humidity	5...95 % RH
Noise level	Max 45 dB
Mounting	Directly on jack shaft
For jack shaft	10...20 mm Ø (round shaft), 10...16 mm (square shaft)
Protection class	IP44 or IP54 with cable glands
Isolation class	III (DAG230: class II)
Certification	CE

Article	Supply voltage	Control signal	Power consumption	Auxiliary switch	Stroke time	Weight
DAG24	24 V AC / DC	on/off or 3 point	Operating: 4.0 W Maintenance: 0.5 W	-	160 s	1100 g
DAG24S	24 V AC / DC	on/off or 3 point	Operating: 4.0 W Maintenance: 0.5 W	2 x 3 (1.5) A / AC 230 V	160 s	1100 g
DAG230	230 V AC	on/off or 3 point	Operating: 4.8 W Maintenance: 1.2 W	-	160 s	1200 g
DAG230S	230 V AC	on/off or 3 point	Operating: 4.8 W Maintenance: 1.2 W	2 x 3 (1.5) A / AC 230 V	160 s	1200 g
DMG24	24 V AC / DC	Y1: 0(2)...10 V DC Y2: 0(4)...20 mA U: 0(2)...10 V DC (feedback signal)	Operating: 2.5 W Maintenance: 0.3 W	-	240 s	1200 g
DMG24S	24 V AC / DC	Y1: 0(2)...10 V DC Y2: 0(4)...20 mA U: 0(2)...10 V DC (feedback signal)	Operating: 2.5 W Maintenance: 0.3 W	2 x 3 (1.5) A / AC 230 V	240 s	1200 g

## DAMPER ACTUATORS WITH SPRING RETURN, 5 NM

Well-suited for applications with security dampers used as antifreeze, antismoke or for sealing in the hygienic-sanitary field.



DAN230F

Technical data	
Max. damper size	1 m <sup>2</sup>
Torque	5 Nm
Frequency	50...60 Hz
Running time, actuator	50...70 s
Running time, spring return	< 20 s
Rotation angle	Operating: 90° Limitation: 5...85° in 5° steps
Ambient temperature	-20...+50 °C
Ambient humidity	5...95 % RH
Noise level	Max 45 dB
Mounting	Directly on jack shaft
For jack shaft	10...16 mm Ø (round shaft), 7...11 mm (square shaft)
Protection class	IP54
Isolation class	II
Certification	CE

Article	Supply voltage	Power consumption	Auxiliary switch	Weight
DAN24F	24 V AC / DC	Operating: 7.2 W Maintenance: 2.5 W	-	1800 g
DAN24FS	24 V AC / DC	Operating: 7.2 W Maintenance: 2.5 W	2 x SPDT 3 (1.5) A / AC 230 V	1800 g
DAN230F	230 V AC	Operating: 4.2 W Maintenance: 2.5 W	-	1900 g
DAN230FS	230 V AC	Operating: 4.2 W Maintenance: 2.5 W	2 x SPDT 3 (1.5) A / AC 230 V	1900 g

## DAMPER ACTUATORS WITH SPRING RETURN, 10 NM

Well-suited for applications with security dampers used as antifreeze, antismoke or for sealing in the hygienic-sanitary field.



DAT230F

Technical data	
Max. damper size	2 m <sup>2</sup>
Torque	10 Nm
Frequency	50...60 Hz
Running time, actuator	100 s
Running time, spring return	25 s
Rotation angle	-5°...+95°
Ambient temperature	-20...+50 °C
Ambient humidity	5...95 % RH
Noise level	Max 45 dB
Mounting	Directly on jack shaft
For jack shaft	10...19 mm Ø (round shaft), 10...16 mm (square shaft)
Weight	2300 g
Protection class	IP54
Isolation class	III (DAT230F: class II)
Certification	CE

Article	Supply voltage	Power consumption	Auxiliary switch
DAT24F	24 V AC / DC	Operating: 5.0 W Maintenance: 2.5 W	-
DAT24FS	24 V AC / DC	Operating: 5.0 W Maintenance: 2.5 W	2 x 3 (1,5) A / AC 230 V
DAT230F	230 V AC	Operating: 6.5 W Maintenance: 2.5 W	-
DAT230FS	230 V AC	Operating: 6.5 W Maintenance: 2.5 W	2 x 3 (1,5) A / AC 230 V

## DAMPER ACTUATORS WITH SPRING RETURN FOR FIRE DAMPERS, 5 NM

Well-suited for applications with security / fire dampers used as antifreeze, antismoke or for sealing in the hygienic-sanitary field.



AF230SE

Technical data	
Max. damper size	1 m <sup>2</sup>
Torque	5 Nm
Frequency	50...60 Hz
Thermal sensor	Duct 72°C
Running time, actuator	50...70 s
Running time, spring return	< 20 s
Rotation angle	90°
Ambient temperature	-20...+50 °C
Ambient humidity	5...95 % RH
Noise level	Max < 45 dB
Mounting	Directly on jack shaft
For jack shaft	12 mm (square shaft)
Protection class	IP54
Isolation class	II
Certification	CE

Article	Supply voltage	Power consumption	Auxiliary switch	Weight
AF24SE	24 V AC / DC	Operating: 7.2 W Maintenance: 2.5 W	2 x SPDT fixed 3 (1.5) A / AC 230 V	1800 g
AF230SE	230 V AC	Operating: 4.2 W Maintenance: 2.5 W	2 x SPDT fixed 3 (1.5) A / AC 230 V	1900 g

## DAMPER ACTUATORS WITH SPRING RETURN FOR FIRE DAMPERS, 8 NM

Well-suited for applications with security / fire dampers used as antifreeze, antismoke or for sealing in the hygienic-sanitary field.



NF24SE

Technical data	
Max. damper size	1.5 m <sup>2</sup>
Torque	8 Nm
Frequency	50...60 Hz
Thermal sensor	Duct 72°C
Running time, actuator	75...95 s
Running time, spring return	< 25 s
Rotation angle	90°
Ambient temperature	-20...+50 °C
Ambient humidity	5...95 % RH
Noise level	Max < 45 dB
Mounting	Directly on jack shaft
For jack shaft	12 mm (square shaft)
Protection class	IP54
Isolation class	II
Certification	CE

Article	Supply voltage	Power consumption	Auxiliary switch	Weight
NF24SE	24 V AC / DC	Operating: 7.0 W Maintenance: 2.0 W	2 SPDT fixed 3 (1.5) A / AC 230 V	2200 g
NF230SE	230 V AC	Operating: 8.0 W Maintenance: 5.5	2 SPDT fixed 3 (1.5) A / AC 230 V	2300 g

## POSITION TRANSDUCER

Article	Supply voltage	Output signal	Control signal	Mounting
DB-PA	24 V AC/DC	0(2)...10 V DC ( $R_{load} > 6K\Omega$ ) (control override)	0(2)...10 V DC	Wall
DB-PF	24 V AC/DC	0(2)...10 V DC ( $R_{load} > 6K\Omega$ ) (control override)	0(2)...10 V DC	Front-end



DB-PA



DB-PF





# 8 Valves and actuators

---

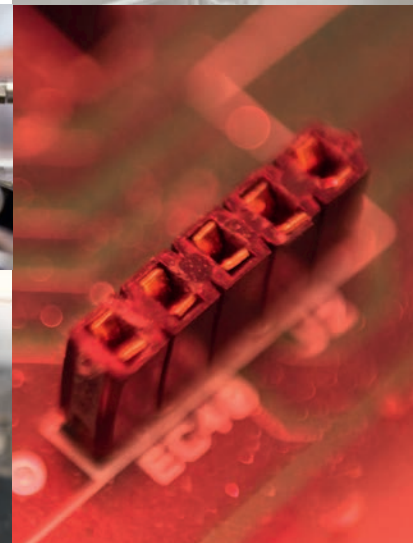
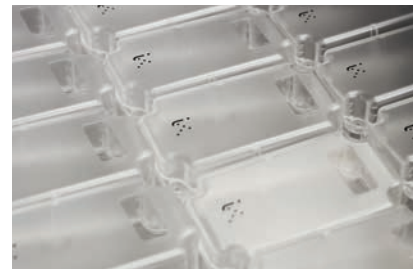





- x** Recommended choice
- ◆ Other possible alternative

### ACTUATORS AND VALVE BODIES COUPLING

					SM	FCA	SEB		
					synchronous, spring return 24 V AC/230 V AC	synchronous, spring return 230 V AC	On/off (3-wire), 24/230 V AC 0...10 V, 24 V AC		
							4 Nm	5Nm	
	DB-VZ	Internally threaded 2-, 3-way		DN 15–25	<b>x</b>				
	FCV	Internally threaded 2-, 3-way		DN 15–32		<b>x</b>			
	VFBV	Internally threaded 2-, 3-way	90°	DN 15–50			<b>x</b>		
				DN 32–50				<b>x</b>	
	VFX2	Externally threaded 2-way	stroke 2.5 mm	DN 15–20					
	VFX3	Externally threaded 3-way							
	VFX4	Externally threaded 3-way, 4 port							
	VFPI VPIM VFPI	Pressure independent valves	stroke 2.7mm	DN 15–25					
	VFMD2 VFMD3	Externally threaded 2-, 3-way	stroke 5.5 mm	DN 15–40					
	VFTR2 VFTR3	Externally threaded 2-, 3-way	stroke 5.5 mm	DN 15–25					
	VFBF2 VFBF3	Internally threaded 2-, 3-way	stroke 20 mm	DN 15–50					
	VFG2 VFG2...N VFG3	Internally threaded 2-, 3-way	stroke 20 mm	DN 15–50					
	VFD2 VFD3	Externally threaded 2-, 3-way	stroke 20 mm	DN 15–50					
	VFFG2 VFFG3	Flanged, 2-way 3-way	stroke 20 mm	DN 25–40					
			stroke 20 mm	DN 50–65					
			stroke 40 mm	DN 80–200					
	VFL2 VFL3	Flanged, 2-way 3-way	stroke 20 mm	DN 65–80					
			stroke 40 mm	DN 100–150					
			stroke 20 mm	DN 65–80					
			stroke 40 mm	DN 100–150					
	VFDH	Flanged, 2-way	stroke 20 mm	DN 15–50					
			stroke 20 mm	DN 65–80					
			stroke 38 mm	DN 100					
			stroke 40 mm	DN 125–150					
	VF	2-way, butterfly valve		DN 32–80					



## CALCULATION OF $K_{vs}$ VALUE

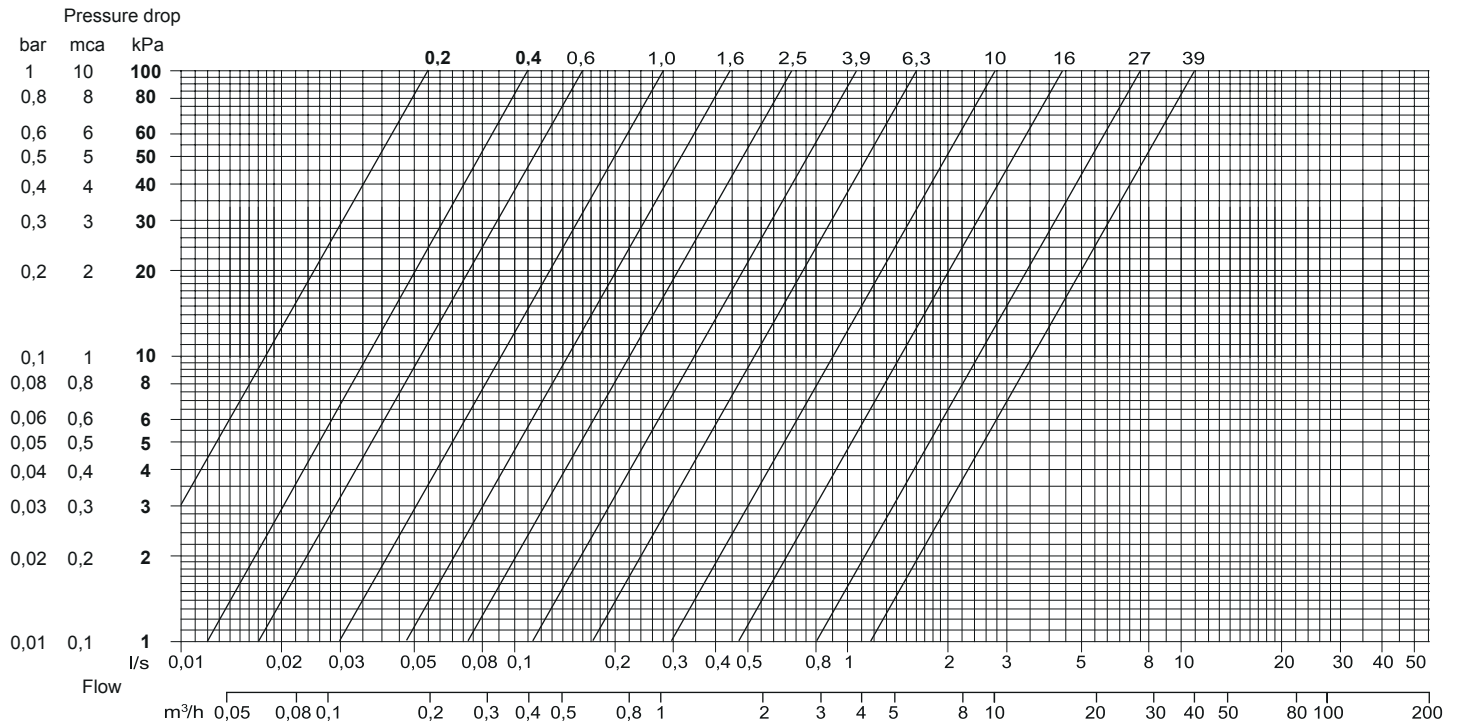

The **pressure drop diagram** allows the Calculation of  $K_{vs}$  for a regulation valve. It correlates the flow rate with the pressure drop. The axes use a logarithmic scale so that you can represent any of  $K_{vs}$  value with a straight line.

Example:

**TO CHOOSE A  $K_{vs}$  VALUE FOR A VALVE HAVING A PRESSURE DROP OF 80 KPA AND A FLOW RATE OF 0,2 L/S:**

- Draw a horizontal line corresponding to the pressure drop value (DP = 80 kPa)
- Draw a vertical line in correspondance of the flow rate value (0.2 l / s)
- Then draw a straight line from the intersection formed up to the nearest  $K_{vs}$  line
- Read the value of the corresponding  $K_{vs}$
- Result: 1.0  $K_{vs}$

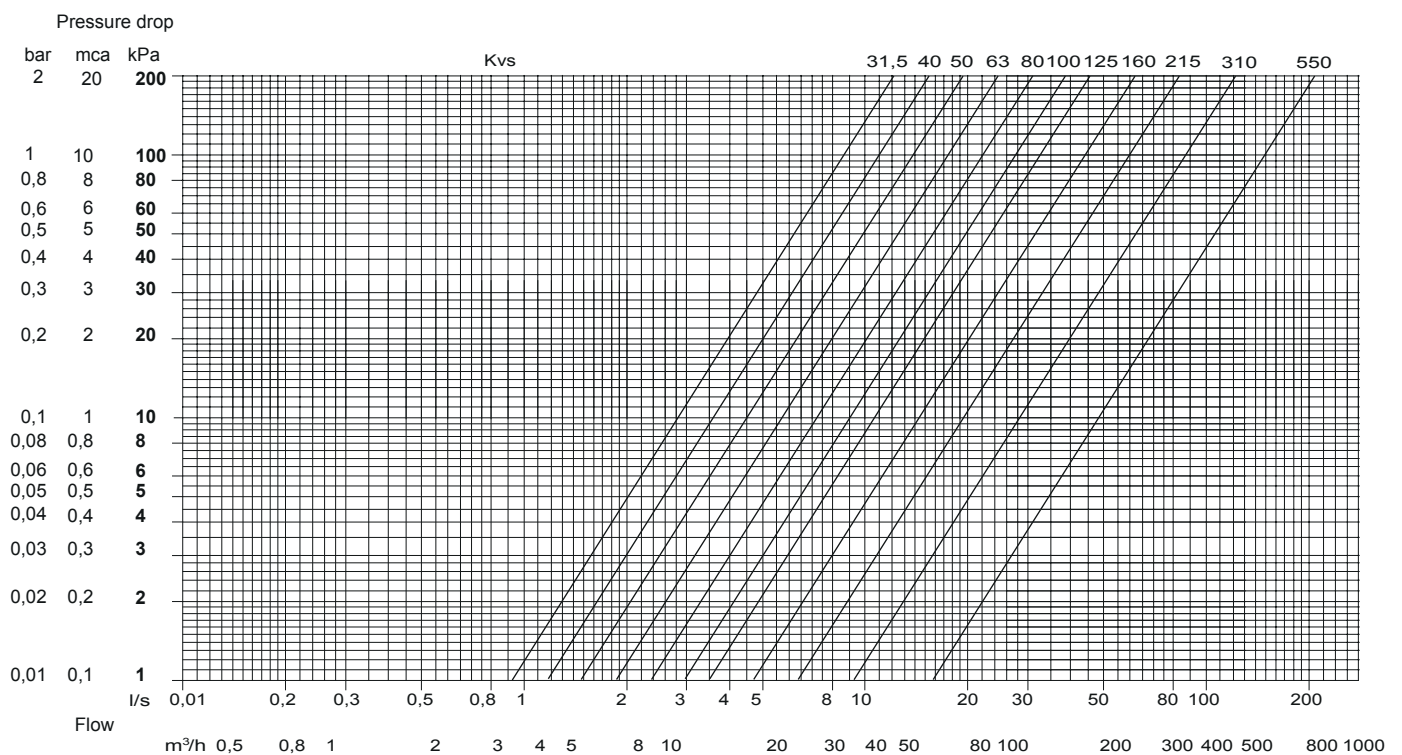

## THERMAL ACTUATORS FOR MANIFOLDS AND VALVES

Thermal actuator to be used on manifolds

Technical data	
Sensor element	Special wax
Power consumption	3 VA
Ambient temperature	0...50 °C
Ambient humidity	10...90 % RH (non-condensing)
Storage temperature	-10...+60 °C Humidity: < 95 % RH
Peak current	SE1C24, SE1C24S < 0.25 A SE1C230, SE1C230S < 1 A
Auxiliary switch	3 A 230 V AC
Cable	PVC, section 2(4) x 0.50 mm <sup>2</sup> , length 1 m
Connection, actuator	Metal ring M30 x 1.5
Material, casing	Matt polycarbonate, self extinguishing V0 - V1 according to UL94
Weight	150 g
Dimensions	Ø 48.5 x h 65 mm
Protection class	IP40 if mounted vertically: IP44 class II (SE1C230, SE1C230S) class III (SE1C24, SE1C24S)
Control signal	On/Off

Article	Supply voltage	Auxiliary switch	Stroke time
SE1C24	24 V AC ± 10%, 50/60 Hz	-	
SE1C230	230 V AC ± 10%, 50/60 Hz	-	
SE1C24S	24 V AC ± 10%, 50/60 Hz	X	
SE1C230S	230 V AC ± 10%, 50/60 Hz	X	



SE1C

### ACCESSORIES

Article	Actuator	Description
ADVFX	SE1C...	Adapter for SE1C/VFX coupling up to Kvs 2.5 to allow the valve to be normally open on direct way
ADV11	SE22.../SE1C...	Adapter for valve with 2.7 mm stroke



Articles available in multipack /M: SE1C.../M (72 pcs.)  
Adapters must be ordered separately.



ADVFX



ADV11

## DB-VZ – ON/OFF ZONE VALVES

On/off control of heat or cool water flow. The valves must be combined with the SM actuator.



DB-VZ2-20

### Technical data valve

Storage temperature	-20...+70 °C
Humidity	< 95 % RH
Media temperature	0...105 °C
Nominal pressure (PN)	16 bar
Weight	270...750 g

### Material

Body	Forged brass
Stem	Stainless steel AISI 302
Packing	NBR

### 2-WAY VALVES

Article	Nominal diameter	Connection	Kvs	Max. diff. pressure
DB-VZ2-15	DN15	G 1/2"	1.6 m <sup>3</sup> /h	250 kPa (2,5 bar)
DB-VZ2-20	DN20	G 3/4"	3.5 m <sup>3</sup> /h	100 kPa (1 bar)
DB-VZ2-25	DN25	G 1"	5.5 m <sup>3</sup> /h	60 kPa (0,6 bar)

### 3-WAY VALVES

Article	Nominal diameter	Connection	Kvs	Max. diff. pressure
DB-VZ3-15	DN15	G 1/2"	1.6 m <sup>3</sup> /h	250 kPa (2,5 bar)
DB-VZ3-20	DN20	G 3/4"	3.5 m <sup>3</sup> /h	100 kPa (1 bar)
DB-VZ3-25	DN25	G 1"	5.5 m <sup>3</sup> /h	60 kPa (0,6 bar)

## ACTUATOR FOR DB-VZ ON/OFF ZONE VALVES

Actuators with auxiliary microswitch for 2-way and 3-way DB-VZ valves.



SM24-CA

Technical data actuator	
Power consumption	7 VA
Load	max. 3A, 125...250 V AC
Opening time	≤ 10 s
Closing time, spring	≤ 5 s
Ambient temperature	2...60 °C
Ambient humidity	10...90 % RH (non-condensing)
Material, casing base	Aluminium alloy casting
Material, casing cover	Fire-proof ABS
Dimensions	77 x 65 x 62 mm
Protection class	IP40
Isolation class	II

### ACTUATORS

Article	Supply voltage	Auxiliary switch
SM230/CA	230 V AC ± 10%	X
SM24/CA	24 V AC ± 10%	X

## PRESSURE INDEPENDENT CONTROL VALVES, DN15-32, 2.7/6 MM STROKE

Pressure independent control valves, DN15-25, 2.7 mm stroke. The valve is a combined differential pressure regulator, flow limiter and equal percentage control valve with full stroke and authority. The pressure independent control valves are suitable for constant or variable temperature systems and can be used as constant flow limiters in constant volume systems (with no actuators), or as pressure independent control valves in variable volume systems (with actuators).

The VFPIP / VFPI / VFPI valves DN15-25 are intended to be used together with ITK's SE1Cxxx or SEZ2xxx actuators.



Technical data	
Application	Heating/cooling systems, fan coil units, radiant cooling and ventilation
Pressure class	25 bar
Flow characteristics	Equal percentage
Rangeability	50 ~ 100 : 1
Max. diff. pressure	600 kPa
Stroke	2,7 mm
Media	Hot water, cold water, glycol-mixed water (max. 50 % glycol)
Max. leakage	0.01 % of maximum flow, Class IV IEC 60534-4
Media temperature	-10...+120 °C
Material	
Body	Brass CW602N (CZ121)
Plug parabol	Brass CW614N (CZ132)
Stem	Stainless steel
O-rings	EPDM
Pressure controller	EPDM, stainless steel and high resistance polymer

### MODELS WITHOUT MEASURING PORT CONNECTORS

Article	Nominal diameter	Connec-tion	Max. flow rate	Max. start up pressure	Rangeability	Stroke	Actuator
VFPI15-150	DN15	G½"	150 l/h	20 kPa	50 ~ 100 : 1	2.7 mm	SE1C230, SE1C24, SEZ2F24/PT, SEZ2F230/PT, SEZ2M24-3.2/PT
VFPI15-600	DN15	G½"	600 l/h	25 kPa	50 ~ 100 : 1	2.7 mm	SE1C230, SE1C24, SEZ2F24/PT, SEZ2F230/PT, SEZ2M24-3.2/PT
VFPI15-900	DN15	G½"	900 l/h	30 kPa	50 ~ 100 : 1	2.7 mm	SE1C230, SE1C24, SEZ2F24/PT, SEZ2F230/PT, SEZ2M24-3.2/PT
VFPI20-600	DN20	G¾"	600 l/h	25 kPa	50 ~ 100 : 1	2.7 mm	SE1C230, SE1C24, SEZ2F24/PT, SEZ2F230/PT, SEZ2M24-3.2/PT
VFPI20-900	DN20	G¾"	900 l/h	30 kPa	50 ~ 100 : 1	2.7 mm	SE1C230, SE1C24, SEZ2F24/PT, SEZ2F230/PT, SEZ2M24-3.2/PT



The VFPI models are non-stock items.

## MODELS WITHOUT MEASURING PORT, WITH MEASURING PORT CONNECTORS

Article	Nominal diameter	Connection	Max. flow rate	Max. start up pressure	Rangeability	Max. diff. pressure	Stroke	Actuator
VFPIP15-150	DN15	G1/2"	150 l/h	20 kPa	50 ~ 100 : 1	600 kPa	2.7 mm	SE1C230, SE1C24, SEZ2F24/PT, SEZ2F230/PT, SEZ2M24-3.2/PT
VFPIP15-600	DN15	G1/2"	600 l/h	25 kPa	50 ~ 100 : 1	600 kPa	2.7 mm	SE1C230, SE1C24, SEZ2F24/PT, SEZ2F230/PT, SEZ2M24-3.2/PT
VFPIP15-780	DN15	G1/2"	780 l/h	35 kPa	50 ~ 100 : 1	600 kPa	2.7 mm	SE1C230, SE1C24, SEZ2F24/PT, SEZ2F230/PT, SEZ2M24-3.2/PT
VFPIP20-1000	DN20	G3/4"	1000 l/h	30 kPa	50 ~ 100 : 1	600 kPa	2.7 mm	SE1C230, SE1C24, SEZ2F24/PT, SEZ2F230/PT, SEZ2M24-3.2/PT
VFPIP20-1500	DN20	G3/4"	1500 l/h	35 kPa	50 ~ 100 : 1	600 kPa	2.7 mm	SE1C230, SE1C24, SEZ2F24/PT, SEZ2F230/PT, SEZ2M24-3.2/PT
VFPIP25-1500	DN25	G1"	1500 l/h	35 kPa	50 ~ 100 : 1	600 kPa	2.7 mm	SE1C230, SE1C24, SEZ2F24/PT, SEZ2F230/PT, SEZ2M24-3.2/PT

## MODELS WITH MEASURING PORTS

Article	Nominal diameter	Connection	Max. flow rate	Max. start up pressure	Rangeability	Stroke	Actuator
VFPI15-150	DN15	G1/2"	150 l/h	20 kPa	50 ~ 100 : 1	2.7 mm	SE1C230, SE1C24, SEZ2F24/PT, SEZ2F230/PT, SEZ2M24-3.2/PT
VFPI15-600	DN15	G1/2"	600 l/h	25 kPa	50 ~ 100 : 1	2.7 mm	SE1C230, SE1C24, SEZ2F24/PT, SEZ2F230/PT, SEZ2M24-3.2/PT
VFPI15-780	DN15	G1/2"	780 l/h	35 kPa	50 ~ 100 : 1	2.7 mm	SE1C230, SE1C24, SEZ2F24/PT, SEZ2F230/PT, SEZ2M24-3.2/PT
VFPI20-1000	DN20	G3/4"	1000 l/h	30 kPa	50 ~ 100 : 1	2.7 mm	SE1C230, SE1C24, SEZ2F24/PT, SEZ2F230/PT, SEZ2M24-3.2/PT
VFPI20-1500	DN20	G3/4"	1500 l/h	35 kPa	50 ~ 100 : 1	2.7 mm	SE1C230, SE1C24, SEZ2F24/PT, SEZ2F230/PT, SEZ2M24-3.2/PT
VFPI25-1500	DN25	G1"	1500 l/h	35 kPa	50 ~ 100 : 1	2.7 mm	SE1C230, SE1C24, SEZ2F24/PT, SEZ2F230/PT, SEZ2M24-3.2/PT

## ACCESSORIES

Article	Actuator	Description
ADV11	SE1C...	Adapter for PIC valves 2.7 mm stroke
ADV12	SEZ2...	Adapter for PICV valves 2.7 mm stroke



ADV11



ADV12



## VALVE ACTUATOR, 24 V OR 230 V SUPPLY VOLTAGE AND 0...10 V OR 2- POINT/3-POINT CONTROL

SEZ2 is a range of electromechanical valve actuators with 200N actuating force intended for control of Industrietechnik's valves VFX, and VFPI/VFPIP (DN15-32 with stroke 2.7 mm/6 mm) as well as for a wide range of other valves on the market.

The actuators can be operated manually with the manual override mechanism, using an Allen key, on the top.



### Technical data

Stroke	1-8.5 mm
Running time	5.5 s / mm
Force	200 N
Visual position indicator	LED
Status and diagnostic indicator	LED
Manual override	By 4 mm Allen key
Ambient temperature	0...50 °C
Ambient humidity	95 % RH, non-condensing
Dimensions (WxHxL)	50 x 88 x 93 mm
Protection class	IP54
Cable length	1.5 m (halogen free)

Article	Control signal	Supply voltage	Power consumption	Inrush current
SEZ2M24	0(2)...10 V/4...20 mA	24 V AC/DC +/- 15%	≤ 6 VA	1.8 A
SEZ2F24	2- point/3-point, 3-wire	24 V AC/DC +/- 15%	≤ 6 VA	1.6 A
SEZ2F230	2- point/3-point, 3-wire	230 V AC/DC +/- 15%	≤ 6 VA	1.2 A

Article	Description
ADV12	Adapter for VFPI valves 2.7 mm stroke or 6 mm stroke
29214112001	Adapter, M28 to M30, for electromechanical actuator SEZ2

## 2- AND 3-WAY ON/OFF VALVES, DN15-32, KVS 3.2-10

Valves, DN15-32, kvs 3.2-10, intended for on/off control of hot or cold water in heating or cooling systems. The valves can only be used together with FCA actuators and are available as both 2- and 3-way models.

Technical data	
Application	Heating systems, cooling systems, fan-coil units, ventilation systems
Max. leakage	0 % of the kvs value
Media	Hot water, cold water, glycol-mixed water (max. 50 % glycol)
Media temperature	2...94 °C
Pressure rating	PN16 (240 psi)
Connection	Internal thread BSP according to ISO 228/1
Material	
Body	Brass CW614N
Ball	EPDM
O-rings	EPDM



FCV-2



FCV-3

### 2-WAY

Article	Nominal diameter	Connection	Kvs	Max. diff. pressure	Actuator
FCV-215	DN15	G1/2"	3.2 m <sup>3</sup> /h	200 kPa	FCA-2
FCV-220	DN20	G3/4"	4.6 m <sup>3</sup> /h	150 kPa	FCA-2
FCV-225	DN25	G1"	5.7 m <sup>3</sup> /h	100 kPa	FCA-2
FCV-232	DN32	G1 1/4"	10 m <sup>3</sup> /h	80 kPa	FCA-2

### 3-WAY

Article	Nominal diameter	Connection	Kvs	Max. diff. pressure	Actuator
FCV-315	DN15	G1/2"	3.2 m <sup>3</sup> /h	150 kPa	FCA-3
FCV-320	DN20	G3/4"	4.6 m <sup>3</sup> /h	100 kPa	FCA-3
FCV-325	DN25	G1"	5.7 m <sup>3</sup> /h	100 kPa	FCA-3
FCV-332	DN32	G1 1/4"	8.4 m <sup>3</sup> /h	80 kPa	FCA-3

## ON/OFF VALVE ACTUATOR FOR ZFCM VALVES

Actuator intended for on/off control of hot or cold water in heating or cooling systems. The actuator has a synchronous motor and spring return mechanism. It is intended for use together with Regin's ZFCM valves.

Technical data	
Supply voltage	230 V AC, 50...60 Hz
Control signal	On/off
Power consumption	6 VA
Opening time	Approx. 15 s
Closing time, spring	4...5 s
Ambient temperature	0...60 °C
Storage temperature	-20...+65 °C
Material	ABS
Dimensions	91 x 68 x 65 mm
Protection class	IP44

Article	Valve
FCA-3	FCV-3
FCA-2	FCV-2



FCA-2

## 2-WAY, 3-WAY AND 3-WAY (BYPASS) ZONE VALVES DN15-20, KVS 0.25-6.0

Valves, DN15-50, kvs 0.6-63, for control of heating and cooling in fan coil or chilled beams applications. The valves are intended to be used together with the thermal SE1 actuators. They are available as 2- and 3-way versions, as well as bypass versions. The valves have linear flow characteristics.



VFX214



VFX237



VFX314



VFX337

### Technical data

Pressure rating	PN16
Connection	BSP externally threaded according to ISO 228/1
Flow characteristics	Linear
Max. leakage	0 % of the kvs value
Media	Hot water, cold water, glycol-mixed water (max. 40 % glycol)
Media temperature	2...95 °C
Stroke	2.5 mm

### Material

Body	Brass CW614N
Plug	PA + GF
Stem	PA + GF
Spring	Stainless steel
Packing box	PPO + GP
O-rings	FKM

### 2-WAY

Article	Nominal diameter	Connection	Kvs, A-AB	Kvs, B-AB	Max. diff. pressure	Actuator
VFX210	DN15	G1/2"	0.25 m <sup>3</sup> /h	- m <sup>3</sup> /h	250 kPa	SE1T / SE1M
VFX211	DN15	G1/2"	0.4 m <sup>3</sup> /h	- m <sup>3</sup> /h	250 kPa	SE1T / SE1M
VFX212	DN15	G1/2"	0.6 m <sup>3</sup> /h	- m <sup>3</sup> /h	250 kPa	SE1T / SE1M
VFX213	DN15	G1/2"	1.0 m <sup>3</sup> /h	- m <sup>3</sup> /h	250 kPa	SE1T / SE1M
VFX214	DN15	G1/2"	1.6 m <sup>3</sup> /h	- m <sup>3</sup> /h	250 kPa	SE1T / SE1M
VFX235	DN20	G3/4"	2.5 m <sup>3</sup> /h	- m <sup>3</sup> /h	250 kPa	SE1T / SE1M
VFX237	DN20	G3/4"	4.0 m <sup>3</sup> /h	- m <sup>3</sup> /h	80 kPa	SE1TP / SE1MP
VFX239	DN20	G3/4"	6.0 m <sup>3</sup> /h	- m <sup>3</sup> /h	80 kPa	SE1TP / SE1MP

### 3-WAY

Article	Nominal diameter	Connection	Kvs, A-AB	Kvs, B-AB	Max. diff. pressure	Actuator
VFX310	DN15	G1/2"	0.25 m <sup>3</sup> /h	0.25 m <sup>3</sup> /h	250 kPa	SE1T / SE1M
VFX311	DN15	G1/2"	0.4 m <sup>3</sup> /h	0.4 m <sup>3</sup> /h	250 kPa	SE1T / SE1M
VFX312	DN15	G1/2"	0.6 m <sup>3</sup> /h	0.6 m <sup>3</sup> /h	250 kPa	SE1T / SE1M
VFX313	DN15	G1/2"	1.0 m <sup>3</sup> /h	0.8 m <sup>3</sup> /h	250 kPa	SE1T / SE1M
VFX314	DN15	G1/2"	1.6 m <sup>3</sup> /h	1.0 m <sup>3</sup> /h	250 kPa	SE1T / SE1M
VFX335	DN20	G3/4"	2.5 m <sup>3</sup> /h	1.6 m <sup>3</sup> /h	250 kPa	SE1T / SE1M
VFX337	DN20	G3/4"	4.0 m <sup>3</sup> /h	2.5 m <sup>3</sup> /h	80 kPa	SE1TP / SE1MP
VFX339	DN20	G3/4"	6.0 m <sup>3</sup> /h	4.0 m <sup>3</sup> /h	80 kPa	SE1TP / SE1MP

### 3-WAY WITH BYPASS

Article	Nominal diameter	Connection	Kvs, A-AB	Kvs, B-AB	Max. diff. pressure	Actuator
VFX410	DN15	G1/2"	0.25 m <sup>3</sup> /h	0.25 m <sup>3</sup> /h	250 kPa	SE1T / SE1M
VFX411	DN15	G1/2"	0.4 m <sup>3</sup> /h	0.4 m <sup>3</sup> /h	250 kPa	SE1T / SE1M
VFX412	DN15	G1/2"	0.6 m <sup>3</sup> /h	0.6 m <sup>3</sup> /h	250 kPa	SE1T / SE1M
VFX413	DN15	G1/2"	1.0 m <sup>3</sup> /h	0.8 m <sup>3</sup> /h	250 kPa	SE1T / SE1M
VFX414	DN15	G1/2"	1.6 m <sup>3</sup> /h	1.0 m <sup>3</sup> /h	250 kPa	SE1T / SE1M
VFX435	DN20	G3/4"	2.5 m <sup>3</sup> /h	1.6 m <sup>3</sup> /h	250 kPa	SE1T / SE1M
VFX437	DN20	G3/4"	4.0 m <sup>3</sup> /h	2.5 m <sup>3</sup> /h	80 kPa	SE1TP / SE1MP
VFX439	DN20	G3/4"	6.0 m <sup>3</sup> /h	4.0 m <sup>3</sup> /h	80 kPa	SE1TP / SE1MP



VFX414



VFX437

### ACCESSORIES

Article	Description
VTP	Override control
ADVFX	Adapter for SE1C/VFX coupling up to Kvs 2.5 to allow the valve to be normally open on direct way



Articles available in multipack /M: VFX21.../M (140 pcs.); VFX31.../M (120 pcs.); VFX 41.../M (100 pcs.); VFX235/M (136 pcs.) VFX335/M (120 pcs.); VFX435/M (80 pcs.)



ADVFX



VTP

## THERMAL ACTUATORS 100/140 N, 2.5 MM STROKE

Thermal actuator with position indicator for control of valves in heating or cooling systems. The actuator can be used to control radiator circuits, solar heating systems, heating or cooling coils, floor heating etc. To be combined with the VFX range of valves.

### Technical data

Stroke	2.5 mm
Ambient temperature	0...50 °C
Ambient humidity	10...90 % RH (non-condensing)
Storage temperature	-20...+70 °C
Storage humidity	< 95 % RH (non-condensing)
Closing/opening time	SE1T230, SE1TP230: 210 s / SE1T24, SE1TP24: 270 s
Peak current	24 V AC: < 0.25 A / 230 V AC: < 0.90 A
Auxiliary switch	250 V AC 3 A
Cable	PVC, section 2 x 0.50 mm <sup>2</sup> , 2 m length
Connection	M30 x 1.5 metal ring
Material, casing	Matt polycarbonate, self extinguishing V0 - V1 according to UL94
Weight	200 g
Dimensions	Ø 40 x 61 mm
Protection class	IP40 (IP44 when vertically mounted)
Isolation class	II (SE1T230, SE1TP230) III (SE1T24, SE1TP24, SE1M24 e SE1MP24)

Article	Force	Supply voltage	Control signal	Power consumption	Stroke time	Auxiliary switch
SE1T24	100 N	24 V AC ± 10 %, 50/60 Hz	On/Off	3.0 VA	4.5 min	-
SE1T24S	100 N	24 V AC ± 10 %, 50/60 Hz	On/Off	3.0 VA	4.5 min	X
SE1T230	100 N	230 V AC ± 10 %, 50/60 Hz	On/Off	3.0 VA	3.5 min	-
SE1TP24	140 N	24 V AC ± 10 %, 50/60 Hz	On/Off	3.0 VA	4.5 min	-
SE1TP24S	140 N	24 V AC ± 10 %, 50/60 Hz	On/Off	3.0 VA	4.5 min	X
SE1TP230	140 N	230 V AC ± 10 %, 50/60 Hz	On/Off	3.0 VA	3.5 min	X
SE1T230S	100 N	230 V AC ± 10 %, 50/60 Hz	On/Off	3.0 VA	3.5 min	X
SE1TP230S	140 N	230 V AC ± 10 %, 50/60 Hz	On/Off	3.0 VA	3.5 min	X
SE1MP24	140 N	24 V AC ± 10 %, 50/60 Hz	0...10 V DC	3.5 VA	3.5 min	-
SE1M24	100 N	24 V AC ± 10 %, 50/60 Hz	0...10 V DC	3.5 VA	4.5 min	-



SE1T230



SE1T230S



SE1M24

## 2-WAY CONTROL VALVES, DN15-50, KVS 0.6-39, 20 MM STROKE

Valves, DN15-50, kvs 0.6-39, 20 mm stroke, designed for control of hot, cold or glycol-mixed water in heating and ventilation systems. They are pressure balanced (from DN20-50, not DN15) and can therefore handle high differential pressure with low force. The valves are intended to be used together with Industrietchnik's SE5... actuators. They should not be used in domestic water systems.



VFG2

Technical data	
Pressure rating	PN16
Connection	BSP internally threaded according to ISO 228/1
Flow characteristics	Equal percentage
Max. leakage	0 % of the Kvs value (PTFE gasket, carbon-filled 25 %, no leakage)
Max. diff. pressure	1600 kPa (16 bar)
Media	Hot water, cold water, glycol-mixed water (max. 50 % glycol)
Media temperature	-5...+140 °C
Rangeability	100:1
Stroke	20 mm
Material	
Body	Brass CW614N
Seat	Brass CW614N
Plug	Stainless steel 1.4301
Stem	Stainless steel 1.4305
Seat packing	PTFE with 25 % carbon
Packing box	Brass CW614N
O-rings	EPDM

### MODELS

Article	Nominal diameter	Connection	Kvs	Actuator
VFG215-0,6	DN15	G½"	0.6 m³/h	SE5
VFG215-1,0	DN15	G½"	1.0 m³/h	SE5
VFG215-1,6	DN15	G½"	1.6 m³/h	SE5
VFG215-2,5	DN15	G½"	2.5 m³/h	SE5
VFG215-4,0	DN15	G½"	4.0 m³/h	SE5
VFG220-1,6	DN20	G¾"	1.6 m³/h	SE5
VFG220-2,7	DN20	G¾"	2.7 m³/h	SE5
VFG220-3,9	DN20	G¾"	3.9 m³/h	SE5
VFG220-6,3	DN20	G¾"	6.3 m³/h	SE5
VFG225-6,3	DN25	G1"	6.3 m³/h	SE5
VFG225-10	DN25	G1"	10 m³/h	SE5
VFG232-10	DN32	G1¼"	10 m³/h	SE5
VFG232-16	DN32	G1¼"	16 m³/h	SE5
VFG240-10	DN40	G1½"	10 m³/h	SE5
VFG240-16	DN40	G1½"	16 m³/h	SE5
VFG240-27	DN40	G1½"	27 m³/h	SE5
VFG250-27	DN50	G2"	27 m³/h	SE5
VFG250-39	DN50	G2"	39 m³/h	SE5

### ACCESSORIES

Article		Description
IS02420001	IS02420001	Spare parts kit, O-ring kit for VFG2 valves from DN15 to DN25 (until 2018-12)
IS6321457301	IS6321457301	Spare parts kit, packing box, for VFG2 valves from DN32 to DN50 (until 2018-12) and FRS valves.
IS2921354201	IS2921354201	Spare parts kit, packing box, for VFG2 (from 2019-01), VFFG (DN25-40), VFBF.



IS02420001



IS6321457301



IS2921354201

## VFG2...N/VFG3 – 2- AND 3-WAY EXTERNALLY THREADED CONTROL VALVES

Valves, DN15-50 kvs 0.63-39, 20 mm stroke, designed for control of hot, cold or glycol-mixed water in heating and ventilation systems. They also function very well in domestic water systems. The valves are intended for use together with SE5... actuators. Valves with DN32-50 may also be used with SE10..., if a larger actuating force is required.



VFG2...N



VFG3

### Technical data

Pressure rating	PN16
Connection	BSP internally threaded according to ISO 228/1
Flow characteristics	Equal percentage
Max. leakage	0.1 % of Kvs
Media	Hot, cold, or glycol-mixed water (max. 50 % glycol)
Media temperature	-5...+150 °C
Rangeability	100:1
Stroke	20 mm
<b>Material</b>	
Body	Gunmetal CC491K (RG5)
Seat	Gunmetal CC491K (RG5)
Plug	Gunmetal CC491K (RG5)
Stem	Stainless steel 1.4305
Packing box	Dezincification resistant brass CW511L
O-rings	Viton

### 2-WAY VALVES

Article	Nominal diameter	Kvs	Connection	$\Delta P_s$ (RVAN5)	$\Delta P_{max}$ (RVAN5)	$\Delta P_s$ (RVAN10)	$\Delta P_{max}$ (RVAN10)
VFG215N-0,63	DN15	0.63 m <sup>3</sup> /h	G½"	1600 kPa	700 kPa	1600 kPa	700 kPa
VFG215N-1,0	DN15	1.0 m <sup>3</sup> /h	G½"	1600 kPa	700 kPa	1600 kPa	700 kPa
VFG215N-1,6	DN15	1.6 m <sup>3</sup> /h	G½"	1600 kPa	700 kPa	1600 kPa	700 kPa
VFG215N-2,1	DN15	2.1 m <sup>3</sup> /h	G½"	1600 kPa	700 kPa	1600 kPa	700 kPa
VFG215N-2,7	DN15	2.7 m <sup>3</sup> /h	G½"	1600 kPa	700 kPa	1600 kPa	700 kPa
VFG220N-4,2	DN20	4.2 m <sup>3</sup> /h	G¾"	1000 kPa	600 kPa	1600 kPa	600 kPa
VFG220N-5,6	DN20	5.6 m <sup>3</sup> /h	G¾"	1000 kPa	600 kPa	1600 kPa	600 kPa
VFG225N-10	DN25	10 m <sup>3</sup> /h	G1"	600 kPa	500 kPa	1400 kPa	500 kPa
VFG232N-16	DN32	16 m <sup>3</sup> /h	G1¼"	400 kPa	400 kPa	800 kPa	450 kPa
VFG240N-27	DN40	27 m <sup>3</sup> /h	G1½"	300 kPa	300 kPa	600 kPa	400 kPa
VFG250N-39	DN50	39 m <sup>3</sup> /h	G2"	200 kPa	200 kPa	400 kPa	300 kPa

### 3-WAY

Article	Nominal diameter	Connection	Max. diff. pressure	Kvs	Actuator
VFG315-0,63	DN15	G½"	1600 kPa	0.63 m³/h	SE5
VFG315-1,0	DN15	G½"	1600 kPa	1.0 m³/h	SE5
VFG315-1,6	DN15	G½"	1600 kPa	1.6 m³/h	SE5
VFG315-2,1	DN15	G½"	1600 kPa	2.1 m³/h	SE5
VFG315-2,7	DN15	G½"	1600 kPa	2.7 m³/h	SE5
VFG320-4,2	DN20	G¾"	1600 kPa	4.2 m³/h	SE5
VFG320-5,6	DN20	G¾"	1600 kPa	5.6 m³/h	SE5
VFG325-10	DN25	G1"	1000 kPa	10 m³/h	SE5
VFG332-16	DN32	G1¼"	600 kPa	16 m³/h	SE5, SE10
VFG340-27	DN40	G1½"	400 kPa	27 m³/h	SE5, SE10
VFG350-39	DN50	G2"	250 kPa	39 m³/h	SE5, SE10

### ACCESSORIES

Article	Description
IS0603080300	Spare parts kit, packing box for ETRS, MTVS and MTRS valves (until 2019-12), for ETVS valves (until 2021-04) and NTVS valves.
IS2921357901	Spare parts kit, packing box for ETRS, MTVS and MTRS valves (from 2020-01) and for ETVS valves (from 2021-05)



IS0603080300



IS2921357901



## 2-WAY CONTROL VALVES, DN15-50, KVS 0.25-40, 20 MM STROKE, DZR

2 way valves, DN15-50, kvs 0.25-40, 20 mm stroke. Designed for control of cold, hot or glycol-mixed water. For use in domestic water systems or district heating within the temperature range -5°C...+150°C. They are pressure balanced (from DN20-50, not DN15) and can therefore handle high differential pressure with low force. The valves are intended to be used together with SE5 actuators.



VFD2

Technical data	
Pressure rating	PN16
Connection	BSP externally threaded according to ISO 228/1; supplied with threaded connections
Flow characteristics	Equal percentage
Max. leakage	0.0 % of the Kvs value (PTFE gasket, carbon-filled 25 %, no leakage)
Media	Hot water, cold water, glycol-mixed water (max. 50 % glycol)
Media temperature	-5...+150 °C
Rangeability	100:1
Stroke	20 mm
Max. diff. pressure	1600 kPa
Material	
Body	Gunmetal CC491K (RG5)
Seat	Stainless steel 1.4301
Plug	Stainless steel 1.4305
Stem	Stainless steel 1.4305
Seat packing	PTFE with 25 % carbon
Packing box	Dezincification resistant brass CW511L
O-rings	EPDM
Material, connections	
Nut	Malleable cast iron, galvanized
Nipple	Dezincification resistant brass CW 511L
Fitting seal	Novatec Premium 2, Nitrile bonded aramid fibre with graphite

### MODELS

Article	Nominal diameter	Kvs	Actuator
VFD215-0,25	DN15	0.25 m <sup>3</sup> /h	SE5
VFD215-0,4	DN15	0.4 m <sup>3</sup> /h	SE5
VFD215-0,63	DN15	0.63 m <sup>3</sup> /h	SE5
VFD215-1,0	DN15	1,0 m <sup>3</sup> /h	SE5
VFD215-1,25	DN15	1.25 m <sup>3</sup> /h	SE5
VFD215-1,6	DN15	1.6 m <sup>3</sup> /h	SE5
VFD215-2,5	DN15	2.5 m <sup>3</sup> /h	SE5
VFD215-4,0	DN15	4 m <sup>3</sup> /h	SE5
VFD220-5,0	DN20	5 m <sup>3</sup> /h	SE5
VFD220-6,3	DN20	6.3 m <sup>3</sup> /h	SE5
VFD225-8,0	DN25	8 m <sup>3</sup> /h	SE5
VFD225-10	DN25	10 m <sup>3</sup> /h	SE5
VFD232-12,5	DN32	12.5 m <sup>3</sup> /h	SE5
VFD232-16	DN32	16 m <sup>3</sup> /h	SE5
VFD240-20	DN40	20 m <sup>3</sup> /h	SE5
VFD240-25	DN40	25 m <sup>3</sup> /h	SE5
VFD250-31,5	DN50	31.5 m <sup>3</sup> /h	SE5
VFD250-40	DN50	40 m <sup>3</sup> /h	SE5

### ACCESSORIES

Article	Description
IS0603080300	Spare parts kit, packing box for VFD3, VFG2 and VFG3 valves (until 2019-12) and for VFD2 (until 2021-04) and VFDH valves.
IS2921357901	Spare parts kit, packing box (from 2020-01)



IS0603080300



IS2921357901

## 3-WAY CONTROL VALVES DN15-50, KVS 0.63-40, 20 MM STROKE, DZR

Valves, DN15-50, kvs 0.63-40, 20 mm stroke, intended for control of cold, hot and glycol-mixed water in heating, ventilation and domestic water systems. The valves are intended to be used together with Industrietechnik's SE5... actuators. Valves with DN32-50 may also be used with SE10 if a larger actuating force is required.



VFD3

Technical data	
Pressure rating	PN16
Connection	BSP externally threaded according to ISO 228/1; supplied with threaded connections
Flow characteristics	Equal percentage
Max. leakage	0.1 % of the kvs value
Media	Hot, cold or glycol-mixed water (max. 50 % glycol)
Media temperature	-5...+150 °C
Rangeability	100:1
Stroke	20 mm
Material	
Body	Gunmetal CC491K (RG5)
Seat	Gunmetal CC491K (RG5)
Plug	Gunmetal CC491K (RG5)
Stem	Stainless steel 1.4305
Packing box	Dezincification resistant brass CW511L
O-rings	EPDM
Material, connections	
Nut	Malleable cast iron, galvanized
Nipple	Dezincification resistant brass CW 511L
Fitting seal	Novatec Premium 2, Nitrile bonded aramid fibre with graphite
Cover lid	Dezincification resistant brass CW 511L

### MODELS

Article	Nominal diameter	Max. diff. pressure	Kvs	Actuator
VFD315-0,63	DN15	1600 kPa	0.63 m <sup>3</sup> /h	SE5
VFD315-1,25	DN15	1600 kPa	1.25 m <sup>3</sup> /h	SE5
VFD315-1,6	DN15	1600 kPa	1.6 m <sup>3</sup> /h	SE5
VFD315-2,5	DN15	1600 kPa	2.5 m <sup>3</sup> /h	SE5
VFD315-4,0	DN15	1600 kPa	4 m <sup>3</sup> /h	SE5
VFD320-5,0	DN20	1600 kPa	5 m <sup>3</sup> /h	SE5
VFD320-6,3	DN20	1600 kPa	6.3 m <sup>3</sup> /h	SE5
VFD325-8,0	DN25	1000 kPa	8 m <sup>3</sup> /h	SE5
VFD325-10	DN25	1000 kPa	10 m <sup>3</sup> /h	SE5
VFD332-12,5	DN32	600 kPa	12.5 m <sup>3</sup> /h	SE5
VFD332-16	DN32	600 kPa	16 m <sup>3</sup> /h	SE5, SE10
VFD340-20	DN40	400 kPa	20 m <sup>3</sup> /h	SE5, SE10
VFD340-25	DN40	400 kPa	25 m <sup>3</sup> /h	SE5, SE10
VFD350-31,5	DN50	250 kPa	31.5 m <sup>3</sup> /h	SE5, SE10
VFD350-40	DN50	250 kPa	40 m <sup>3</sup> /h	SE5, SE10

Article	Description
IS0603080300	Spare parts kit, packing box for VFD3, VFG2 and VFG3 valves (until 2019-12) and for VFD2 (until 2021-04) and VFDH valves.
IS2921357901	Spare parts kit, packing box (from 2020-01)



IS0603080300



IS2921357901

## 2- AND 3-WAY CONTROL VALVES, DN25-200, KVS 6.3-550, DIN-STANDARD

Control valves, DN25-200, kvs 6.3-550, DIN-standard, for use in heating, cooling and ventilation systems. They are intended to be used together with SE actuators. The valves have DIN-standard lengths.



VFFG2



VFFG3

Technical data	
Pressure rating	PN16
Connection	Flanged according to EN 1092-2
Flow characteristics	A - AB = equal percentage, B - AB = linear
Max. leakage	0 % of Kvs
Media	Hot water, cold water, glycol-mixed water (max. 50 % glycol)
Media temperature	-5...+120 °C
Rangeability	100:1 (DN50...200), > 50:1 (DN25...40)
Max. diff. pressure	If a smaller actuator than the suggested one is used, the max. differential pressure may be different. More information is available in the product sheet.
Material	
Body	Grey cast iron EN-JL1040/EN-GJL-250
Plug	Gunmetal 1400 LG2 (DN50...200), Brass CW614N (DN25...40)
Seat	Gunmetal 1400 LG2 (DN50...200), Cast iron Grade 250 (DN25...40)
Stem	Stainless steel 1.4305
Packing box	Brass CW614N
Bonnet	Brass CW614N
O-rings	EPDM
Packing	Aramid reinforced rubber

### 2-WAY VALVES

Article	Kvs	Nominal diameter	Max. diff. pressure	Actuator
VFFG225-6,3	6.3 m <sup>3</sup> /h	DN25	400 kPa	SE5, SE10
VFFG225-10	10 m <sup>3</sup> /h	DN25	400 kPa	SE5, SE10
VFFG232-10	10 m <sup>3</sup> /h	DN32	350 kPa	SE5, SE10
VFFG232-16	16 m <sup>3</sup> /h	DN32	350 kPa	SE5, SE10
VFFG240-16	16 m <sup>3</sup> /h	DN40	300 kPa	SE5, SE10
VFFG240-25	25 m <sup>3</sup> /h	DN40	300 kPa	SE5, SE10
VFFG250-31,5	31.5 m <sup>3</sup> /h	DN50	450 kPa	SE18
VFFG250-40	40 m <sup>3</sup> /h	DN50	450 kPa	SE18
VFFG265-50	50 m <sup>3</sup> /h	DN65	350 kPa	SE18
VFFG265-63	63 m <sup>3</sup> /h	DN65	350 kPa	SE18
VFFG280-80	80 m <sup>3</sup> /h	DN80	300 kPa	SE18
VFFG280-100	100 m <sup>3</sup> /h	DN80	300 kPa	SE18
VFFG2100-125	125 m <sup>3</sup> /h	DN100	200 kPa	SE18
VFFG2100-160	160 m <sup>3</sup> /h	DN100	200 kPa	SE18
VFFG2125-215	215 m <sup>3</sup> /h	DN125	120 kPa	SE25
VFFG2150-310	310 m <sup>3</sup> /h	DN150	100 kPa	SE25
VFFG2200-550	550 m <sup>3</sup> /h	DN200	200 kPa	SE25

### 3-WAY VALVES

Article	Kvs	Nominal diameter	Max. diff. pressure	Actuator
VFFG325-6,3	6.3 m <sup>3</sup> /h	DN25	400 kPa	SE5, SE10
VFFG325-10	10 m <sup>3</sup> /h	DN25	400 kPa	SE5, SE10
VFFG332-10	10 m <sup>3</sup> /h	DN32	350 kPa	SE5, SE10
VFFG332-16	16 m <sup>3</sup> /h	DN32	350 kPa	SE5, SE10
VFFG340-16	16 m <sup>3</sup> /h	DN40	300 kPa	SE5, SE10
VFFG340-25	25 m <sup>3</sup> /h	DN40	300 kPa	SE5, SE10
VFFG350-31,5	31.5 m <sup>3</sup> /h	DN50	450 kPa	SE18
VFFG350-40	40 m <sup>3</sup> /h	DN50	450 kPa	SE18
VFFG365-50	50 m <sup>3</sup> /h	DN65	350 kPa	SE18
VFFG365-63	63 m <sup>3</sup> /h	DN65	350 kPa	SE18
VFFG380-80	80 m <sup>3</sup> /h	DN80	300 kPa	SE18
VFFG380-100	100 m <sup>3</sup> /h	DN80	300 kPa	SE18
VFFG3100-125	125 m <sup>3</sup> /h	DN100	200 kPa	SE18
VFFG3100-160	160 m <sup>3</sup> /h	DN100	200 kPa	SE18
VFFG3125-215	215 m <sup>3</sup> /h	DN125	120 kPa	SE25
VFFG3150-310	310 m <sup>3</sup> /h	DN150	100 kPa	SE25
VFFG3200-550	550 m <sup>3</sup> /h	DN200	70 kPa	SE25

Article	Description
02133005	Washer for actuator, 3 mm thick with ø14 mm hole. For SE5 and SE10 on DN50-65-valves.
IS2921354201	Spare parts kit, packing box, for VFG2 (from 2019-01), VFFG (DN25-40), VFBF.
IS2921351201	Spare parts kit, packing box DN50-200



*For the use of DN 50 and DN65 valves with the SE5 and SE10 actuators, accessory 02133005 is required (to be ordered separately).*



02133005



IS2921354201



IS2921351201

## VFL2/VFL3 – 2- AND 3-WAY DIN-STANDARD FLANGED VALVE

Control valves intended for use in heating, cooling and ventilation systems. They are intended to be used together with the SE 18, SE 25 actuators. The valves have DIN-standard lengths.



VFL2



VFL3

### Technical data

Pressure rating	PN16
Connection	Flanged according to EN 1092-2
Flow characteristics	A → AB: 0-30 % open = linear, 30 - 100 % open = equal percentage B → AB: linear
Max. leakage	A - AB: DN65...DN80 = max 0.1 % of the kvs value, DN100...DN150 = max 0.2 % of the kvs value B - AB: Max 2 % of the kvs value
Media	Hot water, cold water, glycol-mixed water (max. 50 % glycol)
Media temperature	-5...+120 °C
Rangeability	100:1

### Material

Body	Cast iron Grade 200
Seat	Cast iron Grade 200
Plug	Stainless steel 1.4301
Stem	Stainless steel 1.4301
Packing box	Brass CW 617N
Bonnet	Cast iron Grade 200
O-rings	EPDM
Packing	Aramid reinforced rubber

### 3-WAY VALVES

Article	Nominal diameter	Kvs	Stroke	Actuator
VFL265-52	DN65	52 m <sup>3</sup> /h	20 mm	SE18, SE25
VFL80-79	DN80	79 m <sup>3</sup> /h	20 mm	SE18, SE25
VFL2100-124	DN100	124 m <sup>3</sup> /h	40 mm	SE18, SE25
VFL2125-200	DN125	200 m <sup>3</sup> /h	40 mm	SE18, SE25
VFL2150-300	DN150	300 m <sup>3</sup> /h	40 mm	SE18, SE25
VFL365-52	DN65	52 m <sup>3</sup> /h	20 mm	SE18, SE25
VFL380-79	DN80	79 m <sup>3</sup> /h	20 mm	SE18, SE25
VFL3100-124	DN100	124 m <sup>3</sup> /h	40 mm	SE18, SE25
VFL3125-200	DN125	200 m <sup>3</sup> /h	40 mm	SE18, SE25
VFL3150-300	DN150	300 m <sup>3</sup> /h	40 mm	SE18, SE25



For the use of DN65 and DN80 valves with the SE18 and SE25 actuators, accessory 02133011 is required (to be ordered separately).



02133011

## 2-WAY CONTROL VALVES, DN15-150, KVS 0.4-310, DIN-STANDARD

Pressure balanced 2-way valve, DN15-150, kvs 0.4-310, DIN-standard. Intended for control of hot, cold or glycol-mixed water, ideal for district heating within the temperature range -5...+185°C. Intended for use with the SE5.../SE10.../SE18.../SE25... actuators.



VFDH

Technical data	
Pressure rating	PN16
Connection	Flanges according to EN 1092-2
Flow characteristics	Equal percentage
Max. leakage	0.0 % of the kvs value (PTFE gasket, carbon-filled 25 %, no leakage) / 0.05 % of kvs for NTVS...-...M models with metal packing
Media	Hot water, cold water, glycol-mixed water (max. 50 % glycol)
Media temperature	-5...+185 °C
Rangeability	100:1
Max. diff. pressure	1600 kPa
Material	
Body	Nodular cast iron (GJS) EN-JS1050
Seat	Stainless steel 1.4301 (DN15...DN100) or gunmetal CC491K (RG5) (DN125...DN150)
Plug	Stainless steel 1.4305 (DN15...DN100) or gunmetal CC491K (RG5) (DN125...DN150)
Stem	Stainless steel 1.4305
Lining	Stainless steel 1.4301
Seat packing, soft seal	PTFE with 25 % carbon
Seat packing, metal seal	Stainless steel 1.4057
Packing box	Dezincification resistant brass CW 602N, self-adjusting teflon
O-rings	Viton

### MODELS

Article	Nominal diameter	Kvs	Stroke	Actuator
VFDH15-1,6	DN15	1.6 m <sup>3</sup> /h	20 mm	SE5
VFDH15-2,7	DN15	2.7 m <sup>3</sup> /h	20 mm	SE5
VFDH20-6,3	DN20	6.3 m <sup>3</sup> /h	20 mm	SE5
VFDH25-10	DN25	10 m <sup>3</sup> /h	20 mm	SE5
VFDH32-16	DN32	16 m <sup>3</sup> /h	20 mm	SE5
VFDH40-27	DN40	27 m <sup>3</sup> /h	20 mm	SE5
VFDH50-39	DN50	39 m <sup>3</sup> /h	20 mm	SE5
VFDH65-63	DN65	63 m <sup>3</sup> /h	20 mm	SE10
VFDH80-100	DN80	100 m <sup>3</sup> /h	20 mm	SE10
VFDH100-160	DN100	160 m <sup>3</sup> /h	38 mm	SE18
VFDH125-215	DN125	215 m <sup>3</sup> /h	40 mm	SE25
VFDH150-310	DN150	310 m <sup>3</sup> /h	40 mm	SE25

### ACCESSORIES

Article	Description
IS0603080300	Spare parts kit, packing box for ETRS, MTRV and MTRV valves (until 2019-12), for ETRV valves (until 2021-04) and NTRV valves.



IS0603080300

## 2- AND 3-WAY CONTROL VALVES, DN15-50, KVS 0.63-40, 20 MM STROKE

Valves, DN15-50, kvs 0.63-40, 20 mm stroke, designed for control of hot, cold or glycol-mixed water in heating and ventilation systems. The valves are intended for use together with Industrietechnik's SE5.../SE10... actuators.



VFBF2



VFBF3

Technical data	
Application	Heating systems, cooling systems, ventilation systems
Pressure rating	PN16
Connection	BSP internally threaded according to ISO 228/1
Flow characteristics	A - AB = equal percentage, B - AB = linear
Max. leakage	0.1 % of Kvs
Media	Hot water, cold water, glycol-mixed water (max. 50 % glycol)
Media temperature	-5...+140 °C
Rangeability	100:1
Stroke	20 mm
Material	
Body	Brass CW614N
Seat	Brass CW614N
Plug	Brass CW614N
Stem	Stainless steel 1.4305
Packing box	Brass CW614N
O-rings	EPDM

### 2-WAY VALVES

Article	Nominal diameter	Kvs	Connection	Actuator	Max. diff. pressure (SE5...)	Max. diff. pressure (SE10...)
VFBF215-0.63	DN15	0.63 m <sup>3</sup> /h	G ½"	SE5, SE10	700 kPa	700 kPa
VFBF215-1.0	DN15	1.0 m <sup>3</sup> /h	G ½"	SE5, SE10	700 kPa	700 kPa
VFBF215-1.6	DN15	1.6 m <sup>3</sup> /h	G ½"	SE5, SE10	700 kPa	700 kPa
VFBF215-2.1	DN15	2.1 m <sup>3</sup> /h	G ½"	SE5, SE10	700 kPa	700 kPa
VFBF215-2.7	DN15	2.7 m <sup>3</sup> /h	G ½"	SE5, SE10	700 kPa	700 kPa
VFBF220-4.2	DN20	4.2 m <sup>3</sup> /h	G ¾"	SE5, SE10	600 kPa	600 kPa
VFBF220-5.6	DN20	5.6 m <sup>3</sup> /h	G ¾"	SE5, SE10	600 kPa	600 kPa
VFBF225-10	DN25	10 m <sup>3</sup> /h	G 1"	SE5, SE10	500 kPa	500 kPa
VFBF232-16	DN32	16 m <sup>3</sup> /h	G 1¼"	SE5, SE10	400 kPa	450 kPa
VFBF240-25	DN40	25 m <sup>3</sup> /h	G 1½"	SE5, SE10	300 kPa	400 kPa
VFBF250-40	DN50	40 m <sup>3</sup> /h	G 2"	SE5, SE10	200 kPa	300 kPa

### 3-WAY VALVES

Article	Nominal diameter	Kvs	Connection	Actuator	Max. diff. pressure (SE5...)	Max. diff. pressure (SE10...)
IS2921354201						
VFBF315-0.63	DN15	0.63 m <sup>3</sup> /h	G ½"	SE5, SE10	700 kPa	700 kPa
VFBF315-1.0	DN15	1.0 m <sup>3</sup> /h	G ½"	SE5, SE10	700 kPa	700 kPa
VFBF315-1.6	DN15	1.6 m <sup>3</sup> /h	G ½"	SE5, SE10	700 kPa	700 kPa
VFBF315-2.1	DN15	2.1 m <sup>3</sup> /h	G ½"	SE5, SE10	700 kPa	700 kPa
VFBF315-2.7	DN15	2.7 m <sup>3</sup> /h	G ½"	SE5, SE10	700 kPa	700 kPa
VFBF320-4.2	DN20	4.2 m <sup>3</sup> /h	G ¾"	SE5, SE10	600 kPa	600 kPa
VFBF320-5.6	DN20	5.6 m <sup>3</sup> /h	G ¾"	SE5, SE10	600 kPa	600 kPa
VFBF325-10	DN25	10 m <sup>3</sup> /h	G 1"	SE5, SE10	500 kPa	500 kPa
VFBF332-16	DN32	16 m <sup>3</sup> /h	G 1¼"	SE5, SE10	400 kPa	450 kPa
VFBF340-25	DN40	25 m <sup>3</sup> /h	G 1½"	SE5, SE10	300 kPa	400 kPa
VFBF350-40	DN50	40 m <sup>3</sup> /h	G 2"	SE5, SE10	200 kPa	300 kPa

### ACCESSORIES

Article	Description
IS2921354201	Spare parts kit, packing box, for BTV (from 2019-01), GF (DN25-40), BF



IS2921354201

## VALVE ACTUATOR, 24 V SUPPLY VOLTAGE AND 3-POINT CONTROL

Valve actuator for control of Industrietechnik's range of valves. Available in models with actuator force of 500, 1000, 1800 or 2500 N. The actuators can be operated manually with the manual override mechanism on the lid.

### Technical data

Supply voltage	24 V AC
Control signal	3-point
Ambient temperature	0...50 °C
Storage temperature	-40...80 °C
Ambient humidity	10...90 % RH
Protection class	IP54

### MODELS

Article	Max. power consumption	Force	Stroke	Stroke time
SE5F24	7.8 W / 8.0 VA	500 N	10...30 mm	3 s/mm
SE10F24	6.2 W / 6.7 VA	1000 N	10...30 mm	3 s/mm
SE18F24	10.9 W / 11.7 VA	1800 N	10...52 mm	3 s/mm
SE25F24	10.9 W / 11.7 VA	2500 N	10...52 mm	3 s/mm



SE5



SE10



SE18-SE25

## VALVE ACTUATOR, 24 V SUPPLY VOLTAGE AND 0(2)...10 V DC CONTROL

Valve actuator with automatic stroke adjustment for control of Industrietechnik's range of valves. Available in models with actuator force of 500, 1000, 1800 or 2500 N. The actuators can be operated manually with the manual override mechanism on the lid.

### Technical data

Supply voltage	24 V AC/DC
Control signal	0...10 V DC or 2...10 V DC (or 4...20 mA with a 500 Ω resistor connected)
Ambient temperature	0...50 °C
Storage temperature	-40...80 °C
Ambient humidity	10...90 % RH
Protection class	IP54

### MODELS

Article	Max. power consumption	Force	Stroke	Stroke time
SE5M24	5.1 W / 13.9 VA	500 N	10...30 mm	1.5 s/mm
SE10M24	6.2 W / 17.4 VA	1000 N	10...30 mm	1.5 s/mm
SE18M24	8.6 W / 22.4 VA	1800 N	10...52 mm	3 s/mm
SE25M24	8.6 W / 22.4 VA	2500 N	10...52 mm	3 s/mm



SE5



SE10



SE18-SE25



## VALVE ACTUATOR, 230 V SUPPLY VOLTAGE AND 3-POINT CONTROL

Valve actuator for control of Industrietechnik's range of valves. Available in models with actuator force of 500, 1000, 1800 or 2500 N. The actuators can be operated manually with the manual override mechanism on the lid.

### Technical data

Supply voltage	230 V AC $\pm$ 15 %, 50 Hz
Control signal	3-point
Power consumption	15.3 W / 16.5 VA
Ambient temperature	0...50 °C
Storage temperature	-40...+80 °C
Ambient humidity	10...90 % RH
Protection class	IP54

### MODELS

Article	Max. power consumption	Force	Stroke	Stroke time
SE5F230	15.3 W / 16.5 VA	500 N	10...30 mm	3 s/mm
SE10F230	15.3 W / 16.5 VA	1000 N	10...30 mm	3 s/mm
SE18F230	15.3 W / 16.5 VA	1800 N	10...52 mm	3 s/mm
SE25F230	15.3 W / 16.5 VA	2500 N	10...52 mm	3 s/mm



SE5



SE10



SE18-SE25

## 2- AND 3-WAY CONTROL VALVES DN15-40, KVS 0.25-25, 5.5 MM STROKE

Externally threaded control valves, DN15-40, kvs 0.25-25, 5.5 mm stroke. Intended for use in heating and cooling systems together with the SEZ4... series of electromechanical actuators.

Technical data	
Application	Heating systems, cooling systems, fan-coil units, ventilation systems
Pressure rating	PN16
Connection	BSP externally threaded according to ISO 228/1
Flow characteristics	Linear
Max. leakage	0.0 % of kvs
Media	Hot water, cold water, glycol-mixed water (max. 50 % glycol)
Media temperature	2...110 °C
Rangeability	50:1
Stroke	5.5 mm
Material	
Body	Brass CW614N
Seat	Brass CW614N
Plug	Brass CW614N
Stem	Stainless steel 1.4305
Seat packing	EPDM
O-rings	EPDM
Material, connections	
Nut	Malleable cast iron, galvanized
Nipple	Dezincification resistant brass CW 602N (DN15-DN20), Malleable cast iron (DN25-DN40)
Fitting seal	Novatec Premium 2, Nitrile bonded aramid fibre with graphite
Cover lid	Dezincification resistant brass CW 602N



VFMD2



VFMD3

### 2-WAY VALVES

Article	Nominal diameter	Kvs	Max. diff. pressure	Actuator
VFMD215-0.25	DN15	0.25 m <sup>3</sup> /h	400 kPa	SEZ4
VFMD215-0.4	DN15	0.4 m <sup>3</sup> /h	400 kPa	SEZ4
VFMD215-0.6	DN15	0.6 m <sup>3</sup> /h	400 kPa	SEZ4
VFMD215-1.0	DN15	1.0 m <sup>3</sup> /h	400 kPa	SEZ4
VFMD215-1.6	DN15	1.6 m <sup>3</sup> /h	400 kPa	SEZ4
VFMD215-2.5	DN15	2.5 m <sup>3</sup> /h	400 kPa	SEZ4
VFMD215-4.0	DN15	4.0 m <sup>3</sup> /h	400 kPa	SEZ4
VFMD220-6.3	DN20	6.3 m <sup>3</sup> /h	350 kPa	SEZ4
VFMD225-10	DN25	10 m <sup>3</sup> /h	200 kPa	SEZ4
VFMD232-16	DN32	16 m <sup>3</sup> /h	130 kPa	SEZ4
VFMD240-25	DN40	25 m <sup>3</sup> /h	60 kPa	SEZ4

### 3-WAY VALVES

Article	Nominal diameter	Kvs	Max. diff. pressure	Actuator
VFMD315-0.25	DN15	0.25 m <sup>3</sup> /h	400 kPa	SEZ4
VFMD315-0.4	DN15	0.4 m <sup>3</sup> /h	400 kPa	SEZ4
VFMD315-0.6	DN15	0.6 m <sup>3</sup> /h	400 kPa	SEZ4
VFMD315-1.0	DN15	1.0 m <sup>3</sup> /h	400 kPa	SEZ4
VFMD315-1.6	DN15	1.6 m <sup>3</sup> /h	400 kPa	SEZ4
VFMD315-2.5	DN15	2.5 m <sup>3</sup> /h	400 kPa	SEZ4
VFMD315-4.0	DN15	4.0 m <sup>3</sup> /h	400 kPa	SEZ4
VFMD320-6.3	DN20	6.3 m <sup>3</sup> /h	350 kPa	SEZ4
VFMD325-10	DN25	10 m <sup>3</sup> /h	200 kPa	SEZ4
VFMD332-16	DN32	16 m <sup>3</sup> /h	130 kPa	SEZ4
VFMD340-25	DN40	25 m <sup>3</sup> /h	60 kPa	SEZ4

### ACCESSORIES

Article	Description
2951352501	Hand wheel



2951352501

## 2- AND 3-WAY CONTROL VALVES DN15-25, KVS 0.25-7.0, 5.5 MM STROKE

Valves, DN15-25, kvs 0.25-7.0, 5.5 mm stroke, intended for control of hot and cold water in climate, heating and ventilation systems. They can also control glycol-mixed water in for example liquid connected recovery systems. Intended to be used together with the SEZ4 actuators.



VFTR2



VFTR3

### Technical data

Pressure rating	PN16
Connection, actuator	M30 x 1.5
Connection	BSP externally threaded according to ISO 228/1
Flow characteristics	Equal percentage
Max. leakage	0 % of the kvs value
Media temperature	1...110 °C (the valve has a max. temperature of 140°C, the RVAZ4 actuators have a max. temperature of 110°C)
Media	Hot water, cold water, glycol-mixed water (max. 30 % glycol)
Rangeability	50:1
Stroke	5.5 mm

### Material

Body	Brass CW614N
Seat	Brass CW614N
Plug	Brass CW614N
Stem	Stainless steel 1.4305
Seat packing	EPDM
O-rings	EPDM

### 2-WAY VALVES

Article	Nominal diameter	Kvs	Connection	Max. diff. pressure	Actuator
VFTR215-0.25	DN15	0.25 m <sup>3</sup> /h	G1/2"	350 kPa	SEZ4
VFTR215-0.4	DN15	0.4 m <sup>3</sup> /h	G1/2"	350 kPa	SEZ4
VFTR215-0.6	DN15	0.6 m <sup>3</sup> /h	G1/2"	350 kPa	SEZ4
VFTR215-1.0	DN15	1.0 m <sup>3</sup> /h	G1/2"	350 kPa	SEZ4
VFTR215-1.6	DN15	1.6 m <sup>3</sup> /h	G1/2"	350 kPa	SEZ4
VFTR220-2.0	DN20	2.0 m <sup>3</sup> /h	G3/4"	250 kPa	SEZ4
VFTR220-2.5	DN20	2.5 m <sup>3</sup> /h	G3/4"	250 kPa	SEZ4
VFTR220-4.0	DN20	4.0 m <sup>3</sup> /h	G3/4"	150 kPa	SEZ4
VFTR220-6.0	DN20	6.0 m <sup>3</sup> /h	G3/4"	150 kPa	SEZ4
VFTR225-7.0	DN25	7.0 m <sup>3</sup> /h	G1"	70 kPa	SEZ4

### 3-WAY VALVES

Article	Nominal diameter	Kvs	Connection	Max. diff. pressure	Actuator
VFTR315-0.25	DN15	0.25 m <sup>3</sup> /h	G1/2"	350 kPa	SEZ4
VFTR315-0.4	DN15	0.4 m <sup>3</sup> /h	G1/2"	350 kPa	SEZ4
VFTR315-0.6	DN15	0.6 m <sup>3</sup> /h	G1/2"	350 kPa	SEZ4
VFTR315-1.0	DN15	1.0 m <sup>3</sup> /h	G1/2"	350 kPa	SEZ4
VFTR315-1.6	DN15	1.6 m <sup>3</sup> /h	G1/2"	350 kPa	SEZ4
VFTR320-2.0	DN20	2.0 m <sup>3</sup> /h	G3/4"	250 kPa	SEZ4
VFTR320-2.5	DN20	2.5 m <sup>3</sup> /h	G3/4"	250 kPa	SEZ4
VFTR320-4.0	DN20	4.0 m <sup>3</sup> /h	G3/4"	100 kPa	SEZ4
VFTR320-6.0	DN20	6.0 m <sup>3</sup> /h	G3/4"	100 kPa	SEZ4
VFTR325-7.0	DN25	7.0 m <sup>3</sup> /h	G1"	70 kPa	SEZ4

## VALVE ACTUATOR 400 N, 5.5 MM STROKE, 0...10 V OR 3-POSITION CONTROL

The SEZ4 series of valve actuators are easy to mount and have a clear position indication which shows the position of the actuator. The actuator has manual manoeuvring.



SEZ4

### Technical data

Force	400 N
Stroke	5.5 mm
Ambient temperature	0...50 °C
Storage temperature	-10...+80 °C
Media temperature	1...110 °C
Ambient humidity	Max. 95 % RH
Protection class	IP44
Connection	M30 x 1.5

### ACTUATORS FOR INDUSTRIE TECHNIK'S VALVE RANGES VFTR AND VFMD

Article	Supply voltage	Power consumption	Control signal	Stroke time
SEZ4F24	24 V AC ±15 %	0.6 W / 0.6 VA	3-point	150 s
SEZ4M24	24 V AC ±15 %, 24 V DC ±15 %	6 W / 6 VA	0...10 V DC	30 s
SEZ4F230	230 V AC ±15 %, 50/60 Hz	6 W / 6 VA	3-point	150 s

## 2- AND 3-WAY BALL VALVES, DN15-50, KVS 0.6-63

Ball valves, DN15-50, kvs 0.6-63, designed for control of hot, cold or glycol-mixed water in heating and ventilation systems. These ball valves can be used as either characterized control ball valves when a flow plate is installed in port A (default mode), or as on/off ball valves when the flow plate is removed. When the flow plate is removed the Kvs between port A and AB is increased. To be coupled to SEB4 / SEB5 actuators.

Technical data	
Application	Heating systems, cooling systems, ventilation systems
Pressure rating	PN40
Connection	BSP internally threaded according to ISO 228/1
Flow characteristics	A - AB = equal percentage (Flow plate installed), B - AB = linear, On/Off (No flow plate)
Max. leakage	0.0 % of the kvs value
Media	Hot water, cold water, glycol-mixed water (max. 50 % glycol)
Media temperature	-5...+140 °C
Rangeability	100:1
Material	
Body	Brass CW617N
Ball	Chromed brass CW614N
Seat	PTFE
Stem	Stainless steel 1.4305
Flow plate	POM
Circlips	Stainless steel 1.4310
O-rings	EPDM



VFBV2



VFBV3

### 2-WAY VALVES

Article	Nominal diameter	Kvs with flow plate installed in port A	Kvs (On/off, A-AB)	Actuator
VFBV215	DN15	0.6/1.0/1.6/2.5/4.0 m <sup>3</sup> /h	6.3 m <sup>3</sup> /h	SEB4
VFBV220	DN20	6.3 m <sup>3</sup> /h	10 m <sup>3</sup> /h	SEB4
VFBV225	DN25	10 m <sup>3</sup> /h	16 m <sup>3</sup> /h	SEB4
VFBV232	DN32	16 m <sup>3</sup> /h	25 m <sup>3</sup> /h	SEB5
VFBV240	DN40	25 m <sup>3</sup> /h	40 m <sup>3</sup> /h	SEB5
VFBV250	DN50	40 m <sup>3</sup> /h	63 m <sup>3</sup> /h	SEB5

### 3-WAY VALVES

Article	Nominal diameter	Kvs with flow plate installed in port A	Kvs (On/off, A-AB)	Kvs (On/off, B-AB)	Actuator
VFBV315	DN15	0.6/1.0/1.6/2.5/4.0 m <sup>3</sup> /h	6.3 m <sup>3</sup> /h	4 m <sup>3</sup> /h	SEB4
VFBV320	DN20	6.3 m <sup>3</sup> /h	10 m <sup>3</sup> /h	6.3 m <sup>3</sup> /h	SEB4
VFBV325	DN25	10 m <sup>3</sup> /h	16 m <sup>3</sup> /h	10 m <sup>3</sup> /h	SEB4
VFBV332	DN32	16 m <sup>3</sup> /h	25 m <sup>3</sup> /h	16 m <sup>3</sup> /h	SEB5
VFBV340	DN40	25 m <sup>3</sup> /h	40 m <sup>3</sup> /h	25 m <sup>3</sup> /h	SEB5
VFBV350	DN50	40 m <sup>3</sup> /h	63 m <sup>3</sup> /h	40 m <sup>3</sup> /h	SEB5

### ACCESSORIES

Article	Description
VF-HL1	Hand lever for manual operation of ball valves



VF-HL1

## BALL VALVE ACTUATOR FOR VFBV2 AND VFBV3 VALVES

Ball valve actuator with bi-directional motor mainly used in central air-conditioning systems, heating systems, water treatment, and production industry to control the flow of cold/hot media.



SEB

### Technical data

Ambient temperature	-5...+50 °C
Storage temperature	-30...+70 °C
Ambient humidity	Max. 90 % RH (non-condensing)
Protection class	IP54
Working angle	90°
Connection, actuator	Square 9 mm hole with M5 screw

### MODELS

Article	Supply voltage	Power consumption	Control signal	Torque	Running time, actuator	
SEB4F24	24 V AC	3 VA	Floating or On/off (3-wire)	≥ 4 Nm	45 s / 90°	SEB4F24
SEB4M24	24 V AC	4 VA	0(2)...10 V DC or 0(4)...20 mA	≥ 4 Nm	45 s / 90°	SEB4M24
SEB4F230	230 V ~	5 VA	Floating or On/off (3-wire)	≥ 4 Nm	45 s / 90°	SEB4F230
SEB5F24	24 V AC	3 VA	Floating or On/off (3-wire)	≥ 5 Nm	50 s / 90°	SEB5F24
SEB5M24	24 V AC	4 VA	0(2)...10 V DC or 0(4)...20 mA	≥ 5 Nm	50 s / 90°	SEB5M24
SEB5F230	230 V ~	5 VA	Floating or On/off (3-wire)	≥ 5 Nm	50 s / 90°	SEB5F230

## BUTTERFLY VALVES

The VF series of butterfly valves are designed for use in LPW (low pressure water) heating and air conditioning systems.



VF

### Technical data

Pressure rating	PN16
Media temperature	-15...+90 °C

Article	Nominal diameter	Kvs	Max. diff. pressure	Actuator
VF32	DN32	40 m³/h	1000 kPa / 10 bar	DAL... / DML24
VF40	DN40	50 m³/h	1000 kPa / 10 bar	DAL... / DML24
VF50	DN50	99 m³/h	800 kPa / 8 bar	DAL... / DML24
VF65	DN65	170 m³/h	600 kPa / 6 bar	DAL... / DML24
VF80	DN80	261 m³/h	600 kPa / 6 bar	DAG... / DMG24

### ACCESSORY

Article	Description
KIT-VF32/80	Assembly kit for butterfly valves VF with electric actuator



KIT-VF32/80



*The valves are supplied with the assembly kit model KIT-VF32/80.*

## ELECTRIC ACTUATORS FOR VF VALVES SERIES

Bi-directional actuators with manual override, 2 SPDT auxiliary switches, selectable rotation direction, IP44 or IP54 with cable glands.

Article	Torque	Running time, actuator	Supply voltage	Control signal	Auxiliary switch
DAL24S	24	125 s	24 V AC / DC	on/off or 3 point	2 x 3 (1.5) A / AC 230 V
DAL230S	24	125 s	230 V AC	on/off or 3 point	2 x 3 (1.5) A / AC 230 V
DML24S	24	125 s	24 V AC / DC	Y1: 0(2)...10 V DC Y2: 0(4)...20 mA U: 0(2)...10 V DC (feedback signal)	2 x 3 (1.5) A / AC 230 V
DAG24S	32	160 s	24 V AC / DC	on/off or 3 point	2 x 3 (1.5) A / AC 230 V
DAG230S	32	160 s	230 V AC	on/off or 3 point	2 x 3 (1.5) A / AC 230 V
DMG24S	32	240 s	24 V AC / DC	Y1: 0(2)...10 V DC Y2: 0(4)...20 mA U: 0(2)...10 V DC (feedback signal)	2 x 3 (1.5) A / AC 230 V



DAL-DML



DAG-DMG

# Accessories

## VALVE CONNECTIONS FOR COPPER TUBING

Nut and olive for VFTR2, VFTR3 and VFX



Article	Connection	Valve
1885136	1/2", K12	VFTR215, VFTR315, VFTR220, VFTR3
1886274	3/4", K15	VFTR220 (kvs 2.0-2.5), VFTR3 (kvs 2.0-2.5), VFX23x (kvs 2.5), VFX33x (kvs 2.5), VFX43x (kvs 2.5)
1884709	3/4", K18	VFTR220, VFTR3, VFX23x, VFX33x, VFX43x, VFPI20
1886282	1", K22	VFTR225, VFTR315

## STEEL PIPE CONNECTION FOR VFX, VFTR2 AND VFTR3



Article	Description	Valve
OVC-Z15	Pipe connection	VFX2/VFX3/VFX4, VFTR2 (DN15), VFTR3 (DN15)
OVC-Z20	Pipe connection	VFX2/VFX3/VFX4, VFTR2/VFTR3, VFPI (DN20)
OVC-Z25	Pipe connection	VFTR2/VFTR3 (DN25)

## VALVE STEM HEATER

Valve stem heater to be used in systems with media temperatures below 0 °C to prevent freezing and blockage from ice formation. Can be used with all valves when SExxxx-actuator is used.



Technical data	
Supply voltage	24 V AC (22...26 V AC, 50/60 Hz)
Power consumption	50 W
Media temperature	-10...0 °C
Ambient temperature	5...40 °C
Protection class	IP54
Cable length	0.6 m

## MODELS

Article	Description
STEAMHEATER	Valve stem heater



## ADAPTER KIT FOR ADAPTING REGIN'S ACTUATORS TO VALVES OF OTHER BRANDS

### BELIMO

Valve	DN min.-max.	Stroke	Actuator	Adapter type
H4	15 - 50 mm	15 mm	SE5.../SE10...	OVA-015
H5	15 - 50 mm	15 mm	SE5.../SE10...	OVA-015
H6	15 - 50 mm	15 mm	SE5.../SE10...	OVA-015
H6	65 mm (kvs 58)	18 mm	SE10...	OVA-015
H7	15 - 50 mm	15 mm	SE5.../SE10...	OVA-015
H7	65 mm (kvs 58)	18 mm	SE10...	OVA-015
H7	80 mm (kvs 90)	18 mm	SE10...	OVA-015



OVA-015

### CONTROLLI

Valve	DN min.-max.	Stroke	Actuator	Adapter type
VSB	15 - 50 mm	16,5 mm	SE5.../SE10...	OVA-141
VMB	15 - 50 mm	16,5 mm	SE5.../SE10...	OVA-141
VSX..PB	15 - 20 mm	2,5 mm	SE22...	N/A
VSX..PB	15 - 20 mm	5 mm	SE22...	N/A
VSX..PB	25 - 32 mm	5,5 mm	SE22...	N/A
VSXT..PB	15 - 20 mm	2,5 mm	SE22...	N/A
VSXT..PB	15 - 20 mm	5 mm	SE22...	N/A
VSXT..PB	25 - 32 mm	5,5 mm	SE22...	N/A
VSX	15 - 20 mm	2,5 mm	SE22...	N/A
VMX	15 - 20 mm	2,5 mm	SE22...	N/A
VTX	15 - 20 mm	2,5 mm	SE22...	N/A
VSXT	15 - 25 mm	5,5 mm	SE22...	N/A
VMXT	15 - 25 mm	5,5 mm	SE22...	N/A
VLX	15 - 25 mm	4 mm	SE22...	N/A



OVA-141



OVA-020

### DANFOSS

Valve	DN min.-max.	Stroke	Actuator	Adapter type
(H)VF2/(H)VF3	15 - 50 mm	15 mm	SE5.../SE10...	OVA-020
(H)VL2/(H)VL3	15 - 50 mm	15 mm	SE5.../SE10...	OVA-020
(H)VRB2/(H)VRB3	15 mm	10 mm	SE5...	OVA-020
(H)VRB2/(H)VRB3	20 - 50 mm	15 mm	SE5.../SE10...	OVA-020
(H)VRG2/(H)VRG3	15 mm	10 mm	SE5...	OVA-020
(H)VRG2/(H)VRG3	20 - 50 mm	15 mm	SE5.../SE10...	OVA-020
(H)VFS2	15 - 25 mm	15 mm	SE5.../SE10...	OVA-020
VR2/VR3	15 - 25 mm	15 mm	SE5.../SE10...	OVA-020
AB-QM	10 - 20 mm	2,3 mm	SE22...	N/A
AB-QM	25 - 32 mm	4,5 mm	SE22...	N/A

ESBE

Valve	DN min.-max.	Stroke	Actuator	Adapter type
VLF125	15 - 50 mm	20 mm	SE5.../SE10...	OVA-131
VLF135	15 - 50 mm	20 mm	SE5.../SE10...	OVA-131
VLF335	65 - 80 mm	20 mm	SE18.../SE25...	OVA-F4
VLA121	15 - 50 mm	20 mm	SE5.../SE10...	OVA-131
VLA221	15 - 50 mm	20 mm	SE5.../SE10...	OVA-131
VLA131	15 - 50 mm	20 mm	SE5.../SE10...	OVA-131
VLA325	15 - 50 mm	20 mm	SE5.../SE10...	OVA-131
VLA325	65 mm	25 mm	SE5.../SE10...	OVA-131
VLB225	15 - 50 mm	20 mm	SE5.../SE10...	OVA-131
VLB225	65 - 150 mm	40 mm	SE18.../SE25...	OVA-F4
VLA335	15 - 50 mm	20 mm	SE5.../SE10...	OVA-131
VLA335	65 - 150 mm	40 mm	SE18.../SE25...	OVA-F4
VLB335	15-50 mm	20 mm	SE5.../SE10...	OVA-131
VLB335b	65 mm	25 mm	SE5.../SE10...	OVA-131
VLB335	65 mm	25 mm	SE18.../SE25...	OVA-031
VLB335	80-150 mm	45 mm	SE18.../SE25...	OVA-031
VL2FS	20-40 mm	20 mm	SE5.../SE10...	OVA-131
VLB125	65-150 mm	40 mm	SE18.../SE25...	OVA-031
VLB135	65-150 mm	40 mm	SE18.../SE25...	OVA-031
VLB235	15 - 50 mm	20 mm	SE5.../SE10...	OVA-131
VLB235	65 - 150 mm	40 mm	SE18.../SE25...	OVA-F4
VLA425	25 - 50 mm	20 mm	SE5.../SE10...	OVA-131
VLE122	15 - 50 mm	20 mm	SE5.../SE10...	OVA-131
VLE132	15 - 50 mm	20 mm	SE.../SE10...	OVA-131
VLE222	25 - 50 mm	20 mm	SE5.../SE10...	OVA-131
VLE325	20 - 40 mm	20 mm	SE5.../SE10...	OVA-131
VLC125	15 - 50 mm	20 mm	SE5.../SE10...	OVA-131
VLC225	25 - 50 mm	20 mm	SE5.../SE10...	OVA-131
VLC325	15 - 50 mm	20 mm	SE5.../SE10...	OVA-131
VLC425	25 - 50 mm	20 mm	SE5.../SE10...	OVA-131
VL2FC	15 - 50 mm	20 mm	SE5.../SE10...	OVA-131
VL3FC	15 - 50 mm	20 mm	SE5.../SE10...	OVA-131
VL2TA	15 - 50 mm	20 mm	SE5.../SE10...	OVA-131
VL2TAA	25 - 50 mm	20 mm	SE5.../SE10...	OVA-131
VL3TA	15 - 50 mm	20 mm	SE5.../SE10...	OVA-131
VL2FA	15 - 50 mm	20 mm	SE5.../SE10...	OVA-131
VL2FAA	25 - 50 mm	20 mm	SE5.../SE10...	OVA-131
VL3FA	15 - 50 mm	20 mm	SE5.../SE10...	OVA-131
VL2TB	15 - 50 mm	20 mm	SE5.../SE10...	OVA-131
VL2TBA	25 - 50 mm	20 mm	SE5.../SE10...	OVA-131
VL3TB	15 - 50 mm	20 mm	SE5.../SE10...	OVA-131
VL2FD	15 - 50 mm	20 mm	SE5.../SE10...	OVA-131
VL2FDA	25 - 50 mm	20 mm	SE5.../SE10...	OVA-131



OVA-131



OVA-F4

## HONEYWELL

Valve	DN min.-max.	Stroke	Actuator	Adapter type
V5011R	15 - 50 mm	20 mm	SE5.../SE10...	OVA-011
V5013A	15 - 50 mm	20 mm	SE5.../SE10...	OVA-011
V5013F	15 - 50 mm	20 mm	SE5.../SE10...	OVA-011
V5013R	15 - 50 mm	20 mm	SE5.../SE10...	OVA-011
V5015A	100 - 150 mm	38 mm	SE18.../SE25...	OVA-013
V5329C	15 - 80 mm	20 mm	SE5.../SE10...	OVA-011
V5329A	15 - 80 mm	20 mm	SE5.../SE10...	OVA-011
V5016A	15 - 80 mm	20 mm	SE5.../SE10...	OVA-011
V5016A	100 - 150 mm	38 mm	SE18.../SE25...	OVA-013
V5025A	15 - 80 mm	20 mm	SE5.../SE10...	OVA-011
V5025A	100 - 150 mm	38 mm	SE18.../SE25...	OVA-013
V5049A	15 - 80 mm	20 mm	SE5.../SE10...	OVA-011
V5049A	100 - 150 mm	38 mm	SE18.../SE25...	OVA-013
V5050A	15 - 80 mm	20 mm	SE5.../SE10...	OVA-011
V5050A	100 - 150 mm	38 mm	SE18.../SE25...	OVA-013
V5328A	15 - 80 mm	20 mm	SE5.../SE10...	OVA-011
V176A	15 mm	20 mm	SE5.../SE10...	OVA-011
V176B	20 - 80 mm	20 mm	SE5.../SE10...	OVA-011
V176B	100 mm	38 mm	SE18.../SE25...	OVA-013
V538C6xxx	50 - 150 mm	27 - 40 mm	SE18.../SE25...	OVA-013
V538C3xxx	15 - 50 mm	20 mm	SE5.../SE10...	OVA-011
V5004TY Kombi-QM	15 - 25 mm	2,7 mm	SEZ2...	VA748X
V5004TY Kombi-QM	20 - 32 mm	6,0 mm	SEZ2...	VA748X
V186	15 mm	20 mm	SE5.../SE10...	OVA-011
V186	20 - 80 mm	20 mm	SE5.../SE10...	OVA-011
V186	100 mm	38 mm	SE18.../SE25...	OVA-013



OVA-011



OVA-013



VA748X

## JOHNSON

Valve	DN min.-max.	Stroke	Actuator	Adapter type
VG7201/VG7203	25 - 32 mm	13 mm	SE5.../SE10...	OVA-J1
VG7201/VG7203	40 - 50 mm	19 mm	SE5.../SE10...	OVA-J1
VG7401/VG7403	25 - 32 mm	13 mm	SE5.../SE10...	OVA-J1
VG7401/VG7403	40 - 50 mm	19 mm	SE5.../SE10...	OVA-J1
VG7802/VG7804	25 - 32 mm	13 mm	SE5.../SE10...	OVA-J1
VG7802/VG7804	40 - 50 mm	19 mm	SE5.../SE10...	OVA-J1
BM-2xx2	15 - 50 mm	19 mm	SE5.../SE10...	OVA-J1
BM-2xx8	15 - 50 mm	19 mm	SE5.../SE10...	OVA-J1
VG6210	15 - 25 mm	2,5 mm	SE22...	N/A
VG6510	15 - 25 mm	2,5 mm	SE22...	N/A
VG6810	15 - 25 mm	2,5 mm	SE22...	N/A
V5210	10 - 20 mm	4 mm	SE22...	N/A
V5510	10 - 20 mm	3,7 mm	SE22...	N/A
V5810	10 - 20 mm	3,7 mm	SE22...	N/A
VP140	15 - 20 mm	3 mm	SE22...	VA748X
VP140	25 mm	6 mm	SE22...	VA748X



The OVA-J1 adapter applies to valves with a M28x1,5 neck and a 1/4" UNF-28 threaded stem.



OVA-J1



VA748X



OVA-A1

## KIEBACK UND PETER

Valve	DN min.-max.	Stroke	Actuator	Adapter type
RF	15 - 50 mm	14 mm	SE5.../SE10...	OVA-A1
RF	65 - 100 mm	20 - 30 mm	SE18.../SE25...	OVA-A2
RK	15 - 50 mm	14 mm	SE5.../SE10...	OVA-A1
RK	65 - 100 mm	20 - 30 mm	SE18.../SE25...	OVA-A2



OVA-A2

## L&G, L&S, SIEMENS VALVES

Valve	DN min.-max.	Stroke	Actuator	Adapter type
VFF31 (VARISHUNT)	65 mm	40 mm	SE18.../SE25...	OVA-031
VFF32 (VARISHUNT)	65 mm	40 mm	SE18.../SE25...	OVA-031
VFF33 (VARISHUNT)	65 mm	40 mm	SE18.../SE25...	OVA-031
VFF34 (VARISHUNT)	65 mm	40 mm	SE18.../SE25...	OVA-031
VFF35 (VARISHUNT)	65 mm	40 mm	SE18.../SE25...	OVA-031
VFF36 (VARISHUNT)	65 mm	40 mm	SE18.../SE25...	OVA-031
VFG31 (VARISHUNT)	25 - 40 mm	20 mm	SE5.../SE10...	OVA-134
VFG32 (VARISHUNT)	25 - 40 mm	20 mm	SE5.../SE10...	OVA-134
VFG33 (VARISHUNT)	25 - 40 mm	20 mm	SE5.../SE10...	OVA-134
VFG34 (VARISHUNT)	25 - 40 mm	20 mm	SE5.../SE10...	OVA-134
VFG35 (VARISHUNT)	25 - 40 mm	20 mm	SE5.../SE10...	OVA-134
VFG36 (VARISHUNT)	25 - 40 mm	20 mm	SE5.../SE10...	OVA-134
VPF52E	15 - 40 mm	20 mm	SE5.../SE10...	OVA-081
VPF52F	15 - 40 mm	20 mm	SE5.../SE10...	OVA-081
VPI46..	15 - 32 mm	2,5 / 4,5 / 5 mm	SE22	N/A
VPI46..Q	15 - 32 mm	2,5 / 4,5 / 5 mm	SE22	N/A
VPP46..	10 - 32 mm	2,5 / 4,5 / 5 mm	SE22	N/A
VQI46..	15 - 25 mm	4 mm	SE22	N/A
VQI46..Q	15 - 25 mm	4 mm	SE22	N/A
VQP46..	10 - 25 mm	4 mm	SE22	N/A
VQP46--Q	10 - 25 mm	4 mm	SE22	N/A
WVF21	15 - 80 mm	20 mm	SE5.../SE10...	OVA-081
WVF21	100 mm	40 mm	SE18.../SE25...	OVA-082
WVF22	25 - 80 mm	20 mm	SE5.../SE10...	OVA-081
WVF22	25 - 80 mm	20 mm	SE18.../SE25...	OVA-081 + 02133011
WVF22 (until 2015-10)	100 mm	40 mm	SE18.../SE25...	OVA-081 + 02133011
WVF22 (from 2015-10)	100 mm	40 mm	SE18.../SE25...	OVA-082
WVF31	25 - 80 mm	20 mm	SE5.../SE10...	OVA-081
WVF31	100 - 150 mm	40 mm	SE18.../SE25...	OVA-082
WVF32	15 - 80 mm	20 mm	SE5.../SE10...	OVA-081
WVF32	15 - 80 mm	20 mm	SE18.../SE25...	OVA-081 + 02133011
WVF32 (until 2015-10)	100 - 150 mm	40 mm	SE18.../SE25...	OVA-081 + 02133011
WVF32 (from 2015-10)	100 - 150 mm	40 mm	SE18.../SE25...	OVA-082
WVF40	15 - 80 mm	20 mm	SE5.../SE10...	OVA-081
WVF40	100 - 150 mm	40 mm	SE18.../SE25...	OVA-082
WVF41	50 - 150 mm	20/40 mm	SE18.../SE25...	OVA-082
WVF42	15 - 80 mm	20 mm	SE5.../SE10...	OVA-081
WVF42	15 - 80 mm	20 mm	SE18.../SE25...	OVA-081 + 02133011
WVF42 (until 2015-10)	100 - 150 mm	40 mm	SE18.../SE25...	OVA-081 + 02133011
WVF42 (from 2015-10)	100 - 150 mm	40 mm	SE18.../SE25...	OVA-082
WVF42...K	50 - 80 mm	20 mm	SE5.../SE10...	OVA-081
WVF42...K	50 - 80 mm	20 mm	SE18.../SE25...	OVA-081 + 02133011
WVF42...K	100 - 150 mm	40 mm	SE18.../SE25...	OVA-081 + 02133011
WVF43	65 - 250 mm	40 mm	SE18.../SE25...	OVA-081 + 02133011
WVF45	50 - 150 mm	20/40 mm	SE18.../SE25...	OVA-082
WVF51	15 - 40 mm	20 mm	SE5.../SE10...	OVA-081
WVF52	15 - 40 mm	20 mm	SE5.../SE10...	OVA-081
WVF53	15 - 80 mm	20 mm	SE5.../SE10...	OVA-081
WVF53	15 - 80 mm	20 mm	SE18.../SE25...	OVA-081 + 02133011
WVF53	100 - 150 mm	40 mm	SE18.../SE25...	OVA-081 + 02133011
WVF53...K	50 - 80 mm	20 mm	SE5.../SE10...	OVA-081



OVA-031



OVA-134



OVA-081



OVA-082



OVA-L1

Valve	DN min.-max.	Stroke	Actuator	Adapter type
VVF53...K	50 - 80 mm	20 mm	SE18.../SE25...	OVA-081 + 02133011
VVF53...K	100 - 150 mm	40 mm	SE18.../SE25...	OVA-081 + 02133011
VVF53...K	200 - 250 mm	40 mm	SE18.../SE25...	OVA-082
VVF61	15 - 25 mm	20 mm	SE5.../SE10...	OVA-081
VVF61	40 - 150 mm	20/40 mm	SE18.../SE25...	OVA-082
VVG11 (VARIVALVE)	15 mm	5,5 mm	SEZ4L1...	OVA-L1
VVG11	20 - 40 mm	20 mm	SE5.../SE10...	OVA-134
VVG12 (VARIVALVE)	25 - 40 mm	20 mm	SE5.../SE10...	OVA-134
VXF21	25 - 80 mm	20 mm	SE5.../SE10...	OVA-081
VXF21	100 mm	40 mm	SE18.../SE25...	OVA-082
VXF22	25 - 80 mm	20 mm	SE5.../SE10...	OVA-081
VXF22	25 - 80 mm	20 mm	SE18.../SE25...	OVA-081 + 02133011
VXF22 (until 2015-10)	100 mm	40 mm	SE18.../SE25...	OVA-081 + 02133011
VXF22 (from 2015-10)	100 mm	40 mm	SE18.../SE25...	OVA-082
VXF31	25 - 80 mm	20 mm	SE5.../SE10...	OVA-081
VXF31	100 - 150 mm	40 mm	SE18.../SE25...	OVA-082
VXF32	15 - 80 mm	20 mm	SE5.../SE10...	OVA-081
VXF32	15 - 80 mm	20 mm	SE18.../SE25...	OVA-081 + 02133011
VXF32 (until 2015-10)	100 - 150 mm	40 mm	SE18.../SE25...	OVA-081 + 02133011
VXF32 (from 2015-10)	100 - 150 mm	40 mm	SE18.../SE25...	OVA-082
VXF40	15 - 80 mm	20 mm	SE5.../SE10...	OVA-081
VXF40	100 - 150 mm	10 mm	SE18.../SE25...	OVA-082
VXF41	15 - 40 mm	20 mm	SE5.../SE10...	OVA-081
VXF41	50 - 150 mm	40 mm	SE18.../SE25...	OVA-082
VXF42	15 - 80 mm	20 mm	SE5.../SE10...	OVA-081
VXF42	15 - 80 mm	20 mm	SE18.../SE25...	OVA-081 + 02133011
VXF42 (until 2015-10)	100 - 150 mm	40 mm	SE18.../SE25...	OVA-081 + 02133011
VXF42 (from 2015-10)	100 - 150 mm	40 mm	SE18.../SE25...	OVA-082
VXF43	65 - 250 mm	40 mm	SE18.../SE25...	OVA-081 + 02133011
VXF53	15 - 80 mm	20 mm	SE5.../SE10...	OVA-081
VXF61	15 - 25 mm	20 mm	SE5.../SE10...	OVA-081
VXF61	40 - 150 mm	20/40 mm	SE18.../SE25...	OVA-082
VVG41	15 - 50 mm	20 mm	SE5.../SE10...	OVA-081
VXG11 (VARIVALVE)	15 mm	5,5 mm	SEZ4L1...	OVA-L1
VXG11	20 - 40 mm	20 mm	SE5.../SE10...	OVA-134
VXG12 (VARIVALVE)	25 - 40 mm	20 mm	SE5.../SE10...	OVA-134
VXG41	15 - 50 mm	20 mm	SE5.../SE10...	OVA-081
VXG44	15 - 50 mm	5,5 mm	SEZ4L1	OVA-L1
VVG44	15 - 40 mm	5,5 mm	SEZ4L1...	OVA-L1
VVG549	15 - 25 mm	5,5 mm	SEZ4L1...	OVA-L1
VVI52	15 mm	5,5 mm	SEZ4L1...	OVA-L1
VVG55	15 - 25 mm	5,5 mm	SEZ4L1...	OVA-L1
VVP45	10 - 40 mm	5,5 mm	SEZ4L1...	OVA-L1
VXP45	10 - 40 mm	5,5 mm	SEZ4L1...	OVA-L1
VMP43	15 - 20 mm	5,5 mm	SEZ4L1...	OVA-L1
VMP45	10 - 40 mm	5,5 mm	SEZ4L1...	OVA-L1
VVI46	15 - 25 mm	2,5 mm	SEZ2...	N/A
VXI46	15 - 25 mm	2,5 mm	SEZ2...	N/A
VVS46	15 - 25 mm	2,5 mm	SEZ2...	N/A
VXS46	15 - 25 mm	2,5 mm	SEZ2...	N/A
VVP47	10 - 20 mm	2,5 mm	SEZ2...	N/A
VXP47	10 - 20 mm	2,5 mm	SEZ2...	N/A
VMP47	10 - 20 mm	2,5 mm	SEZ2...	N/A

## OVENTROP

Valve	DN min.-max.	Stroke	Actuator	Adapter type
Cocon 2TZ	15 - 20 mm	2,5 mm	SE2...	N/A
Cocon QTZ	10 - 32 mm	2,8 / 3,5 / 4 mm	SE2...	N/A
Tri-M Plus	15 mm	2,5 mm	SE2...	N/A



VA748X

## PETTINAROLI

Valve	DN min.-max.	Stroke	Actuator	Adapter type
91-series	10 - 25 mm	2,7 mm	SE2...	VA748X
92-series	15 - 20 mm	3 mm	SE2...	VA748X
92-series	25 mm	6 mm	SE2...	VA748X
93-series	20 - 32 mm	6 mm	SE2...	VA748X



OVA-133

## REGIN

Valve	DN min.-max.	Stroke	Actuator	Adapter type
VTTV/VTTR/VTTB	15 - 20 mm	2,5 mm	SE2...	N/A

## SATCHWELL

Valve	DN min.-max.	Stroke	Actuator	Adapter type
SVB-XXX-F3	50 - 150 mm	23 - 40 mm	SE18.../SE25...	OVA-133
SVG-XXX-F3	50 - 150 mm	23 - 40 mm	SE18.../SE25...	OVA-133
SVR-XXX-F3	50 - 150 mm	23 - 40 mm	SE18.../SE25...	OVA-133
SVR-G2	15 - 50 mm	20 mm	SE5.../SE10...	OVA-132
SVR-G3	15 - 50 mm	20 mm	SE5.../SE10...	OVA-132
VZ, MVZ	15 - 50 mm	20 mm	SE5.../SE10...	OVA-132
VZF, MVZF	65 - 150 mm	27 - 40 mm	SE18.../SE25...	OVA-133



OVA-132

## SAUTER

Valve	DN min.-max.	Stroke	Actuator	Adapter type
V6R	15 - 50 mm	14 mm	SE5.../SE10...	OVA-151
B6R	15 - 50 mm	14 mm	SE5.../SE10...	OVA-151
VXD	15 - 50 mm	14 mm	SE5.../SE10...	OVA-151
VXE	15 - 50 mm	14 mm	SE5.../SE10...	OVA-151
BXD	15 - 50 mm	14 mm	SE5.../SE10...	OVA-151
BXE	15 - 50 mm	14 mm	SE5.../SE10...	OVA-151
V6F	15 - 50 mm	14 mm	SE5.../SE10...	OVA-151
V6G	15 - 50 mm	14 mm	SE5.../SE10...	OVA-151
V6S	15 - 50 mm	14 mm	SE5.../SE10...	OVA-151
B6F	15 - 50 mm	14 mm	SE5.../SE10...	OVA-151
B6G	15 - 50 mm	14 mm	SE5.../SE10...	OVA-151
B6S	15 - 50 mm	14 mm	SE5.../SE10...	OVA-151
VUL	10 - 20 mm	4 mm	SE2...	N/A
BUL	10 - 20 mm	3,7 mm	SE2...	N/A
VUT	10 - 20 mm	3/4 mm	SE2...	N/A
BUT	10 - 20 mm	3 mm	SE2...	N/A
VXL	10 - 20 mm	2,5 mm	SE2...	N/A
BXL	25 - 40 mm	2,9 mm	SE2...	N/A
VCL	10 - 32 mm	2,8 / 3,5 / 4 mm	SE2...	N/A
VDL	15 - 20 mm	2,5 mm	SE2...	N/A
VDL	15 - 20 mm	5 mm	SE2...	N/A
VDL	25 - 32 mm	5,5 mm	SE2...	N/A



OVA-151

TAC + SCHNEIDER

Valve	DN min.-max.	Stroke	Actuator	Adapter type
STL	20 - 65 mm	31.5 mm	SE18...	OVA-031
STL-SR	20 - 65 mm	22 mm	SE5.../SE10...	OVA-131
V241	15 - 50 mm	20 mm	SE5.../SE10...	OVA-131
V341	15 - 50 mm	20 mm	SE5.../SE10...	OVA-131
V353	15 - 50 mm	20 mm	SE5.../SE10...	OVA-131
V231	15 - 50 mm	20 mm	SE5.../SE10...	OVA-131
V232	25 - 50 mm	20 mm	SE5.../SE10...	OVA-131
V298	20 - 40 mm	22 mm	SE5.../SE10...	OVA-131
V211	15 - 50 mm	20 mm	SE5.../SE10...	OVA-131
V211T	15 - 50 mm	20 mm	SE5.../SE10...	OVA-131
V282	20 - 32 mm	22 mm	SE5.../SE10...	OVA-131
V282	40 - 50 mm	31.5 mm	SE18...	OVA-031
V282	15 mm	15 mm	SE5...	OVA-231
VG211	15 - 50 mm	16.5/25 mm	SE5.../SE10...	OVA-131
VG221F	65 mm	25 mm	SE10...	OVA-131
VG221F	80 - 150 mm	45 mm	SE18.../SE25...	OVA-031
VG222	65 - 150 mm	25/45 mm	SE18.../SE25...	OVA-031
VG311F	65 mm	25 mm	SE10...	OVA-131
VG311F	65 - 150 mm	25/45 mm	SE18.../SE25...	OVA-031
VG321	65 - 150 mm	25 - 45 mm	SE18.../SE25...	OVA-031
VP228E	15 - 20 mm	2,25 mm	SE22...	N/A
VP229E	15 - 20 mm	4 mm	SE22...	N/A
VP229E	25 - 32 mm	4,5 mm	SE22...	N/A
V311	15 - 50 mm	20 mm	SE5.../SE10...	OVA-131
V311T	15 - 50 mm	20 mm	SE5.../SE10...	OVA-131
V212	25 - 50 mm	20 mm	SE5.../SE10...	OVA-131
V212T	25 - 50 mm	20 mm	SE5.../SE10...	OVA-131
V395	40 - 50 mm	20 mm	SE5.../SE10...	OVA-131
V395	65 - 100 mm	30/39.5 mm	SE18.../SE25...	OVA-031
V265	40 - 100 mm	31.5/40.9/50.3 mm	SE18.../SE25...	OVA-031
V221	65 - 100 mm	30/39.5 mm	SE18.../SE25...	OVA-031
V384	20 - 32 mm	22 mm	SE5.../SE10...	OVA-131
V384	40 - 50 mm	31.5 mm	SE18...	OVA-031
V384	15 mm	15 mm	SE5...	OVA-231
V386	20 - 32 mm	22 mm	SE5.../SE10...	OVA-131
V386	40 - 50 mm	31.5 mm	SE18...	OVA-031
V386	15 mm	15 mm	SE5...	OVA-231
V392	20 - 32 mm	22 mm	SE5.../SE10...	OVA-131
V392	40 - 50 mm	31.5 mm	SE18...	OVA-031
V392	15 mm	15 mm	SE5...	OVA-231
V394	20 - 50 mm	20 mm	SE5.../SE10...	OVA-131
V394	40 - 53 mm	31.5 mm	SE18...	OVA-031
V394	15 mm	15 mm	SE5...	OVA-231
V292	20 - 32 mm	22 mm	SE5.../SE10...	OVA-131
V292	40 - 100 mm	31.5/40.9/50.3 mm	SE18.../SE25...	OVA-031
V292	15 mm	15 mm	SE5...	OVA-231
V294	20 - 32 mm	22 mm	SE5.../SE10...	OVA-131
V294	15 mm	15 mm	SE5	OVA-231
V295	20 - 32 mm	22 mm	SE5.../SE10...	OVA-131
V295	40 - 100 mm	31.5/40.9/50.3 mm	SE18.../SE25...	OVA-031
V222	65 - 100 mm	30 mm	SE18...	OVA-031
V321	65 - 100 mm	30 mm	SE18...	OVA-031
VZ28/VZ28C	15 - 20 mm	2,5 mm	SE22...	N/A
VZ38/VZ38C	15 - 20 mm	2,5 mm	SE22...	N/A
VZ48/VZ48C	15 - 20 mm	2,5 mm	SE22...	N/A



OVA-031



OVA-131



OVA-231



## WATTS INDUSTRIES

Valve	DN min.-max.	Stroke	Actuator	Adapter type
2131	15 - 25 mm	2,5 mm	SEZ2...	N/A
3131	15 - 25 mm	2,5 mm	SEZ2...	N/A
4131	15 - 25 mm	2,5 mm	SEZ2...	N/A
4131	15 - 32 mm	3 mm	SEZ2...	N/A

## VIROLINE/VIR

Valve	DN min.-max.	Stroke	Actuator	Adapter type
9700	15 - 32 mm	3 mm	SEZ2...	N/A
9705	15 - 32 mm	3 mm	SEZ2...	N/A
9920	15 - 25 mm	3 mm	SEZ2...	N/A
9925	15 - 25 mm	3 mm	SEZ2...	N/A

## MMA/PURMO

Valve	DN min.-max.	Stroke	Actuator	Adapter type
FVR	15 - 20 mm	1,7 mm	SEZ2...	29214112001
FVRe	15 - 20 mm	1,7 mm	SEZ2...	29214112001
FVV	15 - 20 mm	1,7 mm	SEZ2...	29214112001
FVAV	15 - 20 mm	1,7 mm	SEZ2...	29214112001
FVXR	10 - 15 mm	1,7 mm	SEZ2...	29214112001
VHR	15 - 25 mm	1,7 mm	SEZ2...	29214112001
Evoflow	15 - 20 mm	1,7 mm	SEZ2...	29214112001
TOV	15 - 20 mm	2,5 mm	SEZ2...	N/A
TOV	15 - 20 mm	5 mm	SEZ2...	N/A
TOV	25 - 32 mm	5,5 mm	SEZ2...	N/A



Most MMA / Purmo valves with thread M28 x 1.5 fit with SEZ2 together with adapter 29214112001

## FRESE

Valve	DN min.-max.	Stroke	Actuator	Adapter type
Optima Compact	10 - 32 mm	2,5/5,0/5,5 mm	SEZ2...	N/A

## BROEN

Valve	DN min.-max.	Stroke	Actuator	Adapter type
Ballorex dynamic	15 - 32 mm	3 mm	SEZ2...	N/A

## CALEFFI

Valve	DN min.-max.	Stroke	Actuator	Adapter type
145-series	15 - 25 mm	4 mm	SEZ2...	N/A

## CIMBERIO

Valve	DN min.-max.	Stroke	Actuator	Adapter type
Cim 716	10 - 32 mm	4 mm	SEZ2...	N/A
Cim 717	15 - 32 mm	4 mm	SEZ2...	N/A

## IMI/TA HYDRONIC

Valve	DN min.-max.	Stroke	Actuator	Adapter type
KTM512	15 - 50 mm	10 mm	SE5...	OVA-171
TBV-C	15 - 20 mm	3,7 mm	SEZ2...	N/A
TBV-C	25 mm	4,4 mm	SEZ2...	N/A
TBV-CM	15 - 25 mm	4,3 mm	SEZ2...	N/A
TBV-CMP	15 - 25 mm	4,3 mm	SEZ2...	N/A
KTCM512	15 - 25 mm	4,3 mm	SEZ2...	N/A
TA-COMPACT-P	10 - 32 mm	4,2 mm	SEZ2...	N/A
TA-Modulator	15 - 20 mm	4 mm	SEZ2...	N/A
TA-Modulator	25 - 32 mm	6,5 mm	SEZ2...	N/A
Eclipse	10 - 20 mm	2,5 mm	SEZ2...	N/A
Calypso TRV-3	10 - 20 mm	2,5 mm	SEZ2...	N/A

## CRANE

Valve	DN min.-max.	Stroke	Actuator	Adapter type
D995	15 - 32 mm	4 mm	SEZ2...	N/A

## FLOWCON

Valve	DN min.-max.	Stroke	Actuator	Adapter type
V121G (M6 threaded stem)	15 - 25 mm	3,4 mm	SEZ2...	
V121G (M6 threaded stem)	15 - 25 mm	3,4 mm	SEZ2...	
V121G (M6 threaded stem)	25 - 32 mm	5,2 mm	SEZ2...	

## TIGER CONTROLS

Valve	DN min.-max.	Stroke	Actuator	Adapter type
TD2V	15 - 25 mm	4 mm	SEZ2...	N/A

## ALBION

Valve	DN min.-max.	Stroke	Actuator	Adapter type
ART20	15 - 32 mm	4 mm	SEZ2...	N/A

## HERZ

Valve	DN min.-max.	Stroke	Actuator	Adapter type
4006	15 - 50 mm	4 mm	SEZ2...	N/A
4206	15 - 50 mm	4 mm	SEZ2...	N/A



# 9 Presence and smoke detectors

---

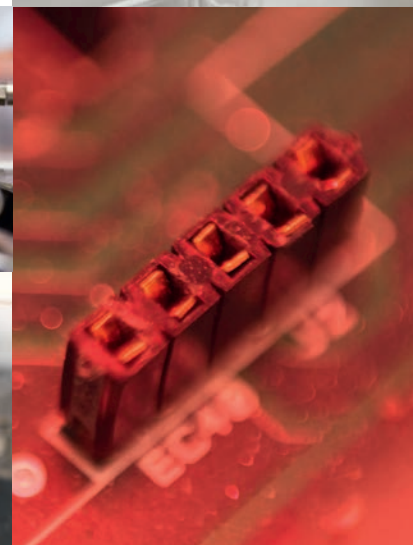
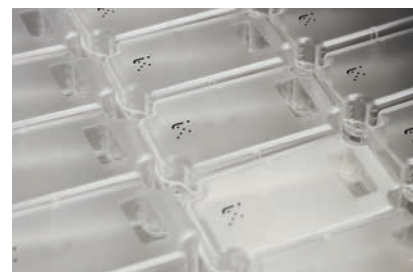

## MOTION DETECTOR

Motion detector with pulse detecting function that minimizes the risk of false triggering. Adjustable on/off delays and change-over relay.



SIR24-PC

Technical data	
Supply voltage	24 AC/DC
Alarm relay	200 mA, 24 V AC/DC, potential-free, change-over relay
Current consumption	5 mA
Temperature range	-20...+50 °C
Ambient humidity	Max. 95 % RH
Dimensions	Wall model: 112 x 66 x 45 mm Ceiling model: Ø 110 x h 44 mm
Protection class	IP20

Article	Mounting	Detection area
SIR24-PC	Ceiling	Height x 2.5 = coverage diameter, 25° angle

## SMOKE DETECTOR FOR DUCT MOUNTING, OPTICAL

Single-tube detector, including 600 mm Venturi tube.



SSDD-OE65

Technical data	
Supply voltage	9...33 V DC (via CABV control unit). 24 V AC ±15 % for RAC models.
Power consumption, incl. end resistor (not RAC(M))	Normal operation: 10 mA at 24 V DC. Alarm condition: 50 mA at 24 V DC. Service alarm condition: 20 mA at 24 V DC.
Mounting	Duct
Tube length	540 mm Ø 30 mm
Dimensions	155 x 115 x 75 mm
Protection class	IP54

Article	Description
SSDD-OE65	Optical detector with service alarm (max 20 sensors, to be connected to CABV control unit) including 600 mm Venturi tube.
SSDD-OE65-RAC	Optical detector with AC power supply and relay output only, with service alarm, including 600 mm Venturi tube.

## ACCESSORIES

Article	Description
SSDD-TDS	Mounting spacer for insulated pipe ducts
SSDD-VR600	Venturi tube, 540 mm length (standard supply together with the detector)
SSDD-VR2000	Venturi tube, 1940 mm length



SSDD-TDS



SSDD-VR600/  
VR2000

## SMOKE DETECTOR FOR CEILING MOUNTING

Smoke detector for all kinds of areas. Constructed to meet the high demands of a modern fire installation. To be used with CABV control unit.

Technical data	
Supply voltage	9...33 V DC (via CABV control unit)
Current consumption	10 mA (50 mA if an alarm occurs)
Mounting	Ceiling
Dimensions	Ø 100 x h 50 mm
Protection class	IP43



SSDC65-OE

### MODELS

Article	Description	Detection principle
SSDC65-OE	Optical detector with service alarm	Optical. Photoelectric, reflecting type



SSDC-BP

### ACCESSORIES

Article	Description
SSDC-BP	Base for detectors
SSDC-BPR-S65	Base for S65 detectors with built-in change-over relay (24 V AC)

## CONTROL UNITS FOR SMOKE DETECTORS

Control unit for smoke detectors. Provides power supply and alarm handling for smoke detectors, with or without service alarm. Two relay contacts for alarm handling.

Technical data	
Current consumption	30 mA (70 mA if an alarm occurs)
Mounting	DIN-rail
Number of modules	3
Dimensions	52 x 85 x 74 mm
Protection class	IP20



CABV24-S-300/D

Article	Supply voltage	Alarm outputs
CABV24-S-300/D	24 V AC/DC	One change-over contact (smoke), one closing contact (smoke), one closing contact (service)
CABV-S-300/D	230 V AC	One change-over contact (smoke), one closing contact (smoke), one closing contact (service)



CABV-S-300/D

## SMOKE SPRAY

Spray for control of smoke detectors. Suitable for control of ionisation or optical smoke detectors.

Article	Description
SPRAY-260	Smoke spray, 260 ml



SPRAY-260



# 10 Miscellaneous products

---

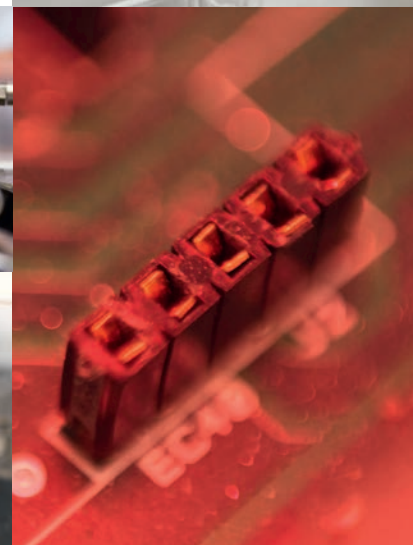
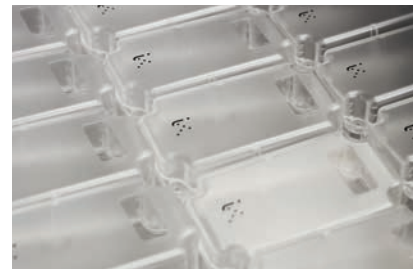



## TRANSFORMER, 15 VA, DIN-RAIL MOUNTING

Transformer with built-in PTC fuse. Overload and short-circuit proof.



TR15-2D

Technical data	
Supply voltage	230 V ~ (230 V ~ 50/60 Hz 15 VA)
Output voltage	12 / 24 V AC
Max. load	15 VA
Mounting	DIN-rail
Number of modules	2
Dimensions, external (WxHxD)	35 x 90 x 60 mm
Protection class	IP20

Article	Description
TR15-2D	Transformer

## TRANSFORMER, 40 VA, DIN-RAIL MOUNTING

Transformer with built-in PTC fuse. Overload and short-circuit proof.



TR40

Technical data	
Supply voltage	230 V ~ (230 V ~ 50/60 Hz 40 VA)
Output voltage	12 V AC and 24 V AC
Max. load	40 VA
Ambient temperature	Max. 40 °C °C
Mounting	DIN-rail
Number of modules	3
Dimensions, external (WxHxD)	53 x 90 x 60 mm
Temperature class	B
Protection class	IP20

Article	Description
TR40	Transformer

## STEP CONTROLLER, 1- AND 2-STAGE

Step controller suitable for heating/cooling or alarm applications. It converts a 0...10 V DC input signal to a relay output. The controller is suitable for DIN-rail or cabinet mounting and have adjustable switching points. The step controller with 2 relays can be set to either binary or sequential control. Individually settable on/off levels



SC1

Technical data	
Supply voltage	24 V AC +/- 15 % 50-60 Hz, 24 V DC (18...35 V DC)
Input signal	0...10 V DC
Output signal	0...10 V DC
Mounting	DIN-rail
Number of modules	3
Dimensions	52 x 85 x 74 mm
Protection class	IP20

Article	Description	Output	Step differential
SC1	Step controller with 1 relay (change-over)	One relay, change-over, 10 A, 250 V AC	-
SC2	Step controller with 2 relays (closing)	Two relays, in closing, 10 A, 250 V AC	0...2 V DC



SC2

## STEP CONTROLLER, 4- OR 6-STAGE

Controller intended for control of electric heating coils, four or six relays. It can be used with any controller with a 0...10 V DC or 10...2 V DC output signal. The step controller also have an analogue output (0...10 V) for control of an electric heating controller to give proportional heating between steps.

Technical data	
Supply voltage	24 V AC, 6 VA
Output	4 alt. 6 relays (closing), binary or sequential control
Input signal	0...10 V DC
Output signal	0...10 V DC
Mounting	DIN-rail
Number of modules	6
Dimensions	100 x 85 x 74 mm
Protection class	IP20

Article	Description	Delay
SC4	Step controller with 4 relays	-
SC6	Step controller with 6 relays	Switch off relay 6 after 3 minutes



SC4



SC6

## FROST PROTECTION UNIT

The electronic frost protection unit is mainly intended for use in air handling systems. If the temperature falls below the setpoint, the relays will fall and an alarm LED lights up. The unit should be connected to an NTC sensor placed on the heating coil or return water pipe. The frost protection unit has two alarm relays and manual or automatic reset. The sensor must have 0...30°C temperature range.

When there is frost risk, the device has a 0...10 V DC control output that can be used to override the valve.

Technical data	
Supply voltage	24 V AC
Power consumption	2 VA
Setpoint	0...15 °C
P-band, control signal override	5 K (fixed)
Mounting	DIN-rail
Number of modules	3
Dimensions	52 x 85 x 74 mm
Protection class	IP20

Inputs	
Sensor inputs	1, 0...30°C (NTC sensor)
Control signal	0...10 V DC (from the controller)
Outputs	
Relays	24 V AC, 1 A, change-over and 230 V AC, 1 A, single contact
Output signal	0...10 V DC

Article	Description
FV	Frost protection unit (delivered without a sensor)



FV



# INDEX

000071	44	DAG24S	112, 148	DBET-7/2	47
02133005	137	DAG230	112	DBET-8	47
104552	97	DAG230S	112, 148	DBET-10	47
1884709	149	DAK24	108	DBET-11	47
1885136	149	DAK24S	108	DBET-16	47
1886274	149	DAK230	108	DBET-16U	47
1886282	149	DAK230S	108	DBET-17	47
2951352501	143	DAL24	111	DBET-18	47
29214112001	126, 158	DAL24S	111, 148	DBET-22	45
984.M	97	DAL230	111	DBET-22/2	45
<b>A</b>		DAL230S	111, 148	DBET-22/2U	45
ADV11	121, 125	DAN24	108	DBET-22U	45
ADV12	125, 126	DAN24F	113	DBET-23	45
ADVFX	121, 129	DAN24FS	113	DBET-23U	45
AF24SE	114	DAN24S	108	DBET-26	45
AF230SE	114	DAN230	108	DBET-26/2	45
AHU	22	DAN230F	113	DBET-26/2U	45
ANS-3	99	DAN230FS	113	DBET-26U	45
ANS-20	99	DAN230S	108	DBET-27	45
AT2090	50	DAS24	109	DBET-27U	45
AT2090U	50	DAS24S	109	DB-I4D/02/001	34
<b>C</b>		DAS230	109	DB-I4D/02/002	34
CA1	24	DAS230S	109	DB-I4D/02/003	34
CABV24-S-300/D	163	DAT24F	114	DB-I4D/02/004	34
CABV-S-300/D	163	DAT24FS	114	DBKH-10	83
CFW	105	DAT230F	114	DBKH-10H	84
CTR25	58	DAT230FS	114	DBKH-10U	83
CTR40	59	DB10MI	91	DBKH-20H	84
CTR80	59	DB15MI	91	DB-KLQ	79
CTR230X010	56	DB20MI	91	DB-KLQ5	79
CTR400X010	56	DB20MI/1	91	DBL-205A	95
CTR2000	57	DB25MI	91	DBL-205B	95
CTR-ADD	56	DB32MI	91	DBL-205C	95
CTR/D	56	DB40MI	91	DBL-205D	95
CTR-M	56	DB50MI	91	DBL-205E	95
CTR-S1	57	DBAT-3	50	DB-M6	96
CTR-X/D	56	DBAT-3U	50	DB-M6P6	96
<b>D</b>		DBAT-5	50	DB-M10	96
DA24	110	DBAT-5U	50	DB-M10P13	96
DA24S	110	DBET-4	47	DB-PA	115
DA230	110	DBET-4/2	47	DB-PF	115
DA230S	110	DBET-4U	47	DB-RLQ	81
DAG24	112	DBET-5	47	DB-RLQ5	81
		DBET-5U	47	DB-TA-3A5-000	31
		DBET-6	47	DB-TA-3C3-13A	32
		DBET-7	47	DB-TA-3C3-19A	32

DB-TA-3C3-99A	32
DB-TA-33A-10A	30
DB-TA-33A-13A	30
DB-TA-323-435	26
DB-TA-335-993	26
DB-TA-343-139	27
DB-TA-345-139	27
DB-TA-345-199	27
DB-TA-345-999	27
DB-TA-363-436	28
DB-TA-383-433	28
DB-TA-385-433	29
DB-TA-387-866	29
DB-TA-393-435	31
DBTV-1	53
DBTV-7U	53
DBTV-8	53
DBTV-11	53
DBTV-16	53
DBTV-17	53
DBTV-18	53
DBTZ-2U	49
DBTZ-7	49
DBTZ-7/2	49
DBTZ-8	49
DBTZ-12U	49
DB-VZ2-15	122
DB-VZ2-20	122
DB-VZ2-25	122
DB-VZ3-15	122
DB-VZ3-20	122
DB-VZ3-25	122
DBZ-01	47, 51, 54
DBZ-02	47, 51, 54
DBZ-06	95, 97
DBZ-08	94
DBZ-09	92
DBZ-14A	95, 97
DBZ-14B	95, 97
DBZ-16	47, 54
DBZ-16/14	53, 54
DBZ-17	47, 54
DBZ-17/14	53, 54
DBZ-17/14/200	54
DBZ-18	54
DBZ-19	54
DBZ-22	76, 80, 89, 90
DBZ-25	48, 49

DBZ-30/14	46, 52, 54
DBZ-31/14	46, 52
DBZ-40/14	52, 54
DBZ-41/14	52, 54
DBZ-90R	69
DBZ-90WN	67
DBZ-135R	69
DBZ-220R	69
DBZ-300R	69
DBZ-AD1	69, 101
DBZH-101	82
DBZH-101U	82
DBZH-102	83
DF	68
DM24	110
DM24S	110
DM230	110
DM230S	110
DMG24	112
DMG24S	112, 148
DMK24	108
DML24	111
DML24S	111, 148
DML230	111
DML230S	111
DMN24	108
DMS24	109
DMS24S	109
DMS230	109
DMS230S	109
DPTD-PT100	67
DPTD-PT1000	67
DTR11N7	35
<b>E</b>	
ET060	44
ET060U	44
ET06060	44
ET06060U	44
<b>F</b>	
FCA-2	127
FCA-3	127
FCV-215	127
FCV-220	127
FCV-225	127
FCV-232	127
FCV-315	127

FCV-320	127
FCV-325	127
FCV-332	127
FH	23
FH-2MCSH1	23
FH-2MSSH1	23
FH-4MCSH1	23
FH-4MSSH1	23
FV	167
<b>I</b>	
IS02420001	131
IS0603080300	133, 134, 135, 139
IS2921351201	137
IS2921354201	131, 137, 140
IS2921357901	133, 134, 135
IS6321457301	131
<b>K</b>	
KIT-VF32/80	147
<b>M</b>	
MR32W	104
<b>N</b>	
NF24SE	115
NF230SE	115
NT0220-NI1000-01	71
NT0220-NI1000-02	71
NT0220-NTC1.8	71
NT0220-NTC2.2	71
NT0220-NTC10-01	71
NT0220-NTC10-02	71
NT0220-NTC10-03	71
NT0220-NTC20	71
NT0220-NTC100	71
NT0420-NI1000-01	71
NT0420-NI1000-02	71
NT0420-NTC1.8	71
NT0420-NTC2.2	71
NT0420-NTC10-01	71
NT0420-NTC10-02	71
NT0420-NTC10-03	71
NT0420-NTC20	71
NT0515-NTC15	72
<b>O</b>	
OVA-011	152

OVA-013	152
OVA-015	150
OVA-020	150
OVA-031	151, 154, 157
OVA-081	154, 155
OVA-081+02133011	154, 155
OVA-082	154, 155
OVA-131	151, 157
OVA-132	156
OVA-133	156
OVA-134	154, 155
OVA-141	150
OVA-151	156
OVA-171	159
OVA-231	157
OVA-A1	153
OVA-A2	153
OVA-F4	151
OVA-J1	153
OVA-L1	155
OVC-Z15	149
OVC-Z20	149
OVC-Z25	149

## P

PASTA-20	62, 63, 72, 73
PC-H	24
PC-T	24
PC-TC	24
PC-U	24
PT0415-PT100	72
PT0415-PT1000	72
PT1020C-PT100	73
PT1020C-PT1000	73
PT1020-PT100	72
PT1020-PT1000	72

## S

SA-NI1000-01	69
SA-NI1000-02	69
SA-NTC1.8	69
SA-NTC2.2	69
SA-NTC10-01	69
SA-NTC10-02	69
SA-NTC10-03	69
SA-NTC15-01	69
SA-NTC15-03	69
SA-NTC15-04	69

SA-NTC20	69
SAP-NI1000-01-2	70
SAP-NI1000-02-2	70
SAP-NTC1.8-2	70
SAP-NTC2.2-2	70
SAP-NTC10-02-2	70
SAP-NTC10-03-2	70
SAP-NTC15-01-3	70
SAP-NTC20-2	70
SAP-PT100-2	70
SAP-PT1000-1	70
SAP-PT1000-2	70
SA-PT100	69
SA-PT1000	69
SAUW	104
SC1	166
SC2	166
SC4	167
SC6	167
SCC-NI1000-01	63
SCC-NI1000-02	63
SCC-NTC1.8	63
SCC-NTC2.2	63
SCC-NTC10-01	63
SCC-NTC10-02	63
SCC-NTC10-02-BR-J	63
SCC-NTC10-03	63
SCC-NTC15-01	63
SCC-NTC20	63
SCC-PT100	63
SCC-PT1000	63
SC-NI1000-01-Y	62
SC-NI1000-02-Y	62
SC-NTC1.8-Y	62
SC-NTC2.2-Y	62
SC-NTC10-02-Y	62
SC-NTC10-03-Y	62
SC-NTC20-Y	62
SC-PT100-Y	62
SC-PT1000-Y	62
SE1C24	121
SE1C24S	121
SE1C230	121
SE1C230S	121
SE1M24	130
SE1MP24	130
SE1T24	130
SE1T24S	130

SE1T230	130
SE1T230S	130
SE1TP24	130
SE1TP24S	130
SE1TP230	130
SE1TP230S	130
SE5F24	141
SE5F230	142
SE5M24	141
SE10F24	141
SE10F230	142
SE10M24	141
SE18F24	141
SE18F230	142
SE18M24	141
SE25F24	141
SE25F230	142
SE25M24	141
SEB4F24	147
SEB4F230	147
SEB4M24	147
SEB5F24	147
SEB5F230	147
SEB5M24	147
SE-NI1000-01-Y	70
SE-NI1000-02-Y	70
SE-NTC1.8-Y	70
SE-NTC2.2-Y	70
SE-NTC10-01-Y	70
SE-NTC10-02-Y	70
SE-NTC10-03-Y	70
SE-NTC20-Y	70
SE-PT100-Y	70
SE-PT1000-Y	70
SET-30	73
SET-PT1000	73
SEW	104
SEW-PT1000	104
SEZ2F24	126
SEZ2F230	126
SEZ2M24	126
SEZ4F24	145
SEZ4F230	145
SEZ4M24	145
SF1E	92
SF1K	92
SF1RE	92
SF2EI	92

SF2REI	92
SF3E	92
SF4E	92
SF6E	92
SI-NI1000-01-Y	66
SI-NI1000-02-Y	66
SI-NTC1.8-Y	66
SI-NTC2.2-Y	66
SI-NTC10-01-Y	66
SI-NTC10-02-Y	66
SI-NTC10-03-Y	66
SI-NTC20-Y	66
SI-PT100-Y	66
SI-PT1000-Y	66
SIR24-PC	162
SIR-PW	105
SIR-SW	105
SL1E	94
SM24/CA	123
SM230/CA	123
SPRAY-260	163
SQ01	102
SSDC65-OE	163
SSDC-BP	163
SSDC-BPR-S65	163
SSDD-OE65	162
SSDD-OE65-RAC	162
SSDD-TDS	162
SSDD-VR600	162
SSDD-VR2000	162
STCC-NI1000-01	65
STCC-NI1000-02	65
STCC-NTC1.8	65
STCC-NTC2.2	65
STCC-NTC10-01	65
STCC-NTC10-02	65
STCC-NTC10-03	65
STCC-NTC15-01	65
STCC-NTC15-02	65
STCC-NTC15-03	65
STCC-NTC15-04	65
STCC-NTC20	65
STCC-PT100	65
STCC-PT1000	65
STC-NI1000-01-Y	64
STC-NI1000-02-Y	64
STC-NTC1.8-Y	64
STC-NTC2.2-Y	64

STC-NTC10-01-Y	64
STC-NTC10-02-Y	64
STC-NTC10-03-Y	64
STC-NTC20-Y	64
STC-PT100-Y	64
STC-PT1000/430-Y	64
STC-PT1000-Y	64
STEAMHEATER	149
STIC-NI1000-01/135	68
STIC-NI1000-01/220	68
STIC-NI1000-01/300	68
STIC-NI1000-02/135	68
STIC-NI1000-02/220	68
STIC-NI1000-02/300	68
STIC-NTC1.8/135	68
STIC-NTC1.8/220	68
STIC-NTC1.8/300	68
STIC-NTC2.2/135	68
STIC-NTC2.2/220	68
STIC-NTC2.2/300	68
STIC-NTC10-01/135	68
STIC-NTC10-01/220	68
STIC-NTC10-01/300	68
STIC-NTC10-02/135	68
STIC-NTC10-02/220	68
STIC-NTC10-02/300	68
STIC-NTC10-03/135	68
STIC-NTC10-03/220	68
STIC-NTC10-03/300	68
STIC-NTC20/135	68
STIC-NTC20/220	68
STIC-NTC20/300	68
STIC-PT100/135	68
STIC-PT100/220	68
STIC-PT100/300	68
STIC-PT1000/135	68
STIC-PT1000/220	68
STIC-PT1000/300	68
STI-NI1000-01-Y	67
STI-NI1000-02-Y	67
STI-NTC1.8-Y	67
STI-NTC2.2-Y	67
STI-NTC10-01-Y	67
STI-NTC10-02-Y	67
STI-NTC10-03-Y	67
STI-NTC20-Y	67
STI-PT100-Y	67
STI-PT1000-Y	67

STM-PT1000-Y	65
--------------	----

## T

TA31/I	44
TA33/I	44
TA34/I	44
TAE1	25
TAE2	25
TC060	46
TC090	46
TCO1	81
TCO2A	78
TCO2A-D	78
TCO2A-D-M	78
TCO2A-D-NI1000-01	78
TCO2A-D-NI1000-02	78
TCO2A-D-NTC1.8	78
TCO2A-D-NTC2.2	78
TCO2A-D-NTC10-01	78
TCO2A-D-NTC10-02	78
TCO2A-D-NTC10-03	78
TCO2A-D-NTC20	78
TCO2A-D-PT100	78
TCO2A-D-PT1000	78
TCO2A-M	78
TCO2A-NI1000-01	78
TCO2A-NI1000-02	78
TCO2A-NTC1.8	78
TCO2A-NTC2.2	78
TCO2A-NTC10-01	78
TCO2A-NTC10-02	78
TCO2A-NTC10-03	78
TCO2A-NTC20	78
TCO2A-PT100	78
TCO2A-PT1000	78
TCO2AU	79
TCO2AU-D	79
TCO2AU-D-M	79
TCO2AU-D-NI1000-01	79
TCO2AU-D-NI1000-02	79
TCO2AU-D-NTC1.8	79
TCO2AU-D-NTC2.2	79
TCO2AU-D-NTC10-01	79
TCO2AU-D-NTC10-02	79
TCO2AU-D-NTC10-03	79
TCO2AU-D-NTC20	79
TCO2AU-D-PT100	79
TCO2AU-D-PT1000	79

TCO2AU-M	79	TPDL10	101	TTC021	76
TCO2AU-NI1000-01	79	TPDL10-420	101	TTC022	76
TCO2AU-NI1000-02	79	TPDL20	101	TTC023	76
TCO2AU-NTC1.8	79	TPDL20-420	101	TTE011	76
TCO2AU-NTC2.2	79	TPDL40	101	TTE012	76
TCO2AU-NTC10-01	79	TPDL40-420	101	TTE013	76
TCO2AU-NTC10-02	79	TPDL100	101	TTE021	76
TCO2AU-NTC10-03	79	TPDL100-420	101	TTE022	76
TCO2AU-NTC20	79	TPDL250	101	TTE023	76
TCO2AU-PT100	79	TPDL250-420	101	TTI011	77
TCO2AU-PT1000	79	TPDL400	101	TTI012	77
TCO2C	80	TPDL400-420	101	TTI013	77
TCO2C-05	80	TPDL600	101	TTI021	77
TCO2C-NI1000-01	80	TPDL600-420	101	TTI022	77
TCO2C-NI1000-02	80	TPDL1000	101	TTI023	77
TCO2C-NTC1.8	80	TPDL1000-420	101	TTUA	86
TCO2C-NTC2.2	80	TPDL1600	101	TTUA-C	85
TCO2C-NTC10-01	80	TPDL1600-420	101	TTUA-CD	85
TCO2C-NTC10-02	80	TPDL2500	101	TTUA-D	86
TCO2C-NTC10-03	80	TPDL2500-420	101	TTUA-D-M	86
TCO2C-NTC20	80	TPDL-NIPPEL	101	TTUA-D-NI1000-01	86
TCO2C-PT100	80	TPDL-R	101	TTUA-D-NI1000-02	86
TCO2C-PT1000	80	TPGL1	100	TTUA-D-NTC1.8	86
TF18	51	TPGL1-420	100	TTUA-D-NTC2.2	86
TF18R	51	TPGL2.5	100	TTUA-D-NTC10-01	86
TF30	51	TPGL2.5-420	100	TTUA-D-NTC10-02	86
TF30R	51	TPGL6	100	TTUA-D-NTC10-03	86
TF60	51	TPGL6-420	100	TTUA-D-NTC20	86
TF60R	51	TPGL10	100	TTUA-D-PT100	86
TF150	51	TPGL10-420	100	TTUA-D-PT1000	86
TF150R	51	TPGL16	100	TTUA-M	86
TH	20	TPGL16-420	100	TTUA-NI1000-01	86
THS2	21	TPGL25	100	TTUA-NI1000-02	86
THS2-0MM	21	TPGL25-420	100	TTUA-NTC1.8	86
TPDA	98	TPGL40	100	TTUA-NTC2.2	86
TPDA12A	100	TPGL40-420	100	TTUA-NTC10-01	86
TPDA-12CX	99	TPL105074	101	TTUA-NTC10-02	86
TPDA-12CX2	99	TR15-2D	166	TTUA-NTC10-03	86
TPDA-12CXS25C	99	TR40	166	TTUA-NTC20	86
TPDA-12CXS75C	99	TTA	75	TTUA-PT100	86
TPDA25A	100	TTA-C	75	TTUA-PT1000	86
TPDA-25CX	99	TTA-CD	75	TUA	84
TPDA-25CX2C	99	TTA-D	75	TUA-C	85
TPDA75A	100	TTA-D-M	75	TUA-CD	85
TPDA-75CX	99	TTA-M	75	TUA-D	84
TPDA1225A2	100	TTC011	76	TUA-D-M	84
TPDA1275A2	100	TTC012	76	TUA-M	84
TPDA-C	98	TTC013	76	TUC1	89



TUC2	89	TV09090U	52	VFD215-0,25	134
TUC3	89	TVR6585	52	VFD215-0,63	134
TUE1	87	TVR90110	52	VFD215-1,0	134
TUE2	87	TZ090U	48	VFD215-1,6	134
TUE3	87	TZR6585	48	VFD215-1,25	134
TUTC0111	90	<b>V</b>		VFD215-2,5	134
TUTC0121	90			VFD215-4,0	134
TUTC0131	90	VA748X	152, 153, 156	VFD220-5,0	134
TUTC0212	90	VF32	147	VFD220-6,3	134
TUTC0222	90	VF40	147	VFD225-8,0	134
TUTC0232	90	VF50	147	VFD225-10	134
TUTC1101	90	VF65	147	VFD232-12,5	134
TUTC1102	90	VF80	147	VFD232-16	134
TUTC1103	90	VFBF215-0.63	140	VFD240-20	134
TUTC1301	90	VFBF215-1.0	140	VFD240-25	134
TUTC1302	90	VFBF215-1.6	140	VFD250-31,5	134
TUTC1401	90	VFBF215-2.1	140	VFD250-40	134
TUTC1402	90	VFBF215-2.7	140	VFD315-0,63	135
TUTC1501	90	VFBF220-4.2	140	VFD315-1,6	135
TUTC1502	90	VFBF220-5.6	140	VFD315-1,25	135
TUTC1601	90	VFBF225-10	140	VFD315-2,5	135
TUTC1602	90	VFBF232-16	140	VFD315-4,0	135
TUTC1701	90	VFBF240-25	140	VFD320-5,0	135
TUTC2101	90	VFBF250-40	140	VFD320-6,3	135
TUTC2102	90	VFBF315-0.63	140	VFD325-8,0	135
TUTE0111	88	VFBF315-1.0	140	VFD325-10	135
TUTE0121	88	VFBF315-1.6	140	VFD332-12,5	135
TUTE0131	88	VFBF315-2.1	140	VFD332-16	135
TUTE0212	88	VFBF315-2.7	140	VFD340-20	135
TUTE0222	88	VFBF320-4.2	140	VFD340-25	135
TUTE0232	88	VFBF320-5.6	140	VFD350-31,5	135
TUTE1101	88	VFBF325-10	140	VFD350-40	135
TUTE1102	88	VFBF332-16	140	VFDH15-1,6	139
TUTE1103	88	VFBF340-25	140	VFDH15-2,7	139
TUTE1301	88	VFBF350-40	140	VFDH20-6,3	139
TUTE1302	88	VFBV215	146	VFDH25-10	139
TUTE1401	88	VFBV220	146	VFDH32-16	139
TUTE1402	88	VFBV225	146	VFDH40-27	139
TUTE1501	88	VFBV232	146	VFDH50-39	139
TUTE1502	88	VFBV240	146	VFDH65-63	139
TUTE1601	88	VFBV250	146	VFDH80-100	139
TUTE1602	88	VFBV315	146	VFDH100-160	139
TUTE1701	88	VFBV320	146	VFDH125-215	139
TUTE2101	88	VFBV325	146	VFDH150-310	139
TUTE2102	88	VFBV332	146	VFFG225-6,3	136
TV090	52	VFBV340	146	VFFG225-10	136
TV090U	52	VFBV350	146	VFFG232-10	136
TV090UR85	52	VFD215-0,4	134	VFFG232-16	136

VFFG240-16	136	VFG225N-10	132	VFMD315-1.6	143
VFFG240-25	136	VFG232-10	131	VFMD315-2.5	143
VFFG250-31,5	136	VFG232-16	131	VFMD315-4.0	143
VFFG250-40	136	VFG232N-16	132	VFMD320-6.3	143
VFFG265-50	136	VFG240-10	131	VFMD325-10	143
VFFG265-63	136	VFG240-16	131	VFMD332-16	143
VFFG280-80	136	VFG240-27	131	VFMD340-25	143
VFFG280-100	136	VFG240N-27	132	VFPI15-150	124
VFFG325-6,3	137	VFG250-27	131	VFPI15-600	124
VFFG325-10	137	VFG250-39	131	VFPI15-900	124
VFFG332-10	137	VFG250N-39	132	VFPI20-600	124
VFFG332-16	137	VFG315-0,63	133	VFPI20-900	124
VFFG340-16	137	VFG315-1,0	133	VFPI15-150	125
VFFG340-25	137	VFG315-1,6	133	VFPI15-600	125
VFFG350-31,5	137	VFG315-2,1	133	VFPI15-780	125
VFFG350-40	137	VFG315-2,7	133	VFPI20-1000	125
VFFG365-50	137	VFG320-4,2	133	VFPI20-1500	125
VFFG365-63	137	VFG320-5,6	133	VFPI25-1500	125
VFFG380-80	137	VFG325-10	133	VFPIP15-150	125
VFFG380-100	137	VFG332-16	133	VFPIP15-600	125
VFFG2100-125	136	VFG340-27	133	VFPIP15-780	125
VFFG2100-160	136	VFG350-39	133	VFPIP20-1000	125
VFFG2125-215	136	VF-HL1	146	VFPIP20-1500	125
VFFG2150-310	136	VFL80-79	138	VFPIP25-1500	125
VFFG2200-550	136	VFL265-52	138	VFTR215-0.4	144
VFFG3100-125	137	VFL365-52	138	VFTR215-0.6	144
VFFG3100-160	137	VFL380-79	138	VFTR215-0.25	144
VFFG3125-215	137	VFL2100-124	138	VFTR215-1.0	144
VFFG3150-310	137	VFL2125-200	138	VFTR215-1.6	144
VFFG3200-550	137	VFL2150-300	138	VFTR220-2.0	144
VFG215-0,6	131	VFL3100-124	138	VFTR220-2.5	144
VFG215-1,0	131	VFL3125-200	138	VFTR220-4.0	144
VFG215-1,6	131	VFL3150-300	138	VFTR220-6.0	144
VFG215-2,5	131	VFMD215-0.4	143	VFTR225-7.0	144
VFG215-4,0	131	VFMD215-0.6	143	VFTR315-0.4	144
VFG215N-0,63	132	VFMD215-0.25	143	VFTR315-0.6	144
VFG215N-1,0	132	VFMD215-1.0	143	VFTR315-0.25	144
VFG215N-1,6	132	VFMD215-1.6	143	VFTR315-1.0	144
VFG215N-2,1	132	VFMD215-2.5	143	VFTR315-1.6	144
VFG215N-2,7	132	VFMD215-4.0	143	VFTR320-2.0	144
VFG220-1,6	131	VFMD220-6.3	143	VFTR320-2.5	144
VFG220-2,7	131	VFMD225-10	143	VFTR320-4.0	144
VFG220-3,9	131	VFMD232-16	143	VFTR320-6.0	144
VFG220-6,3	131	VFMD240-25	143	VFTR325-7.0	144
VFG220N-4,2	132	VFMD315-0.4	143	VFX210	128
VFG220N-5,6	132	VFMD315-0.6	143	VFX211	128
VFG225-6,3	131	VFMD315-0.25	143	VFX212	128
VFG225-10	131	VFMD315-1.0	143	VFX213	128

VFX214	128
VFX235	128
VFX237	128
VFX239	128
VFX310	128
VFX311	128
VFX312	128
VFX313	128
VFX314	128
VFX335	128
VFX337	128
VFX339	128
VFX410	129
VFX411	129
VFX412	129
VFX413	129
VFX414	129
VFX435	129
VFX437	129
VFX439	129
VTP	129



# General sales conditions of AB Industrietechnik SRL

THIS ISSUE REPLACES AND CANCELS ALL PREVIOUS ONES AND IS SUBJECT TO MODIFICATION WITHOUT PRIOR NOTICE. THE BUYER FULLY ACCEPTS THESE GENERAL SALES CONDITIONS.

## PRICES

The prices mentioned in our current price list are in Euro (€), do not include VAT and, even if confirmed, may be subject to variations due to increases in raw materials and labour costs. If the price is tied to parity between the Euro and a foreign currency, the rate of exchange value is specified by the Banca d'Italia, as indicated in the „Il Sole 24 Ore“ daily newspaper. If the rate of exchange varies by more than 5%, we reserve the right to modify at any time our prices and the discounts applied to current orders. In such a case, the buyer is entitled to withdraw immediately from the order. The said prices do not include transport and insurance costs, import license expenses, customs charges, etc., which are considered chargeable to the Buyer.

Our quotations are not binding for the order; the Buyer accepts our delivery terms.

After issuing our order acknowledgement, the order is confirmed.

For invoices under € 50,00 net a sum of € 10,00 will be applied for management cost.

Neutral products:

are supplied without a surcharge but with a minimum of 50 pieces/part number.

Customized products pad printing:

- cliché cost for colour € 95,00 (max 2 colours)

- tampography on box, min. 100 pieces/order, surcharge of € 1,50 net/piece. For higher quantities, the surcharge may be discussed.

Customized products laser printing:

- cliché costs € 85,00 (grayscale)

- laser printing on plastics min. 20 pieces / order, no surcharges for higher quantities.

The products, wherever possible, can be supplied with a test certificate (part number 103999) at the net price of € 31,00 net + VAT to be requested during the ordering process. Certificates of origin issued by the Chamber of Commerce cost € 50,00. Certificates legalized by foreign embassy min. € 250,00.

## PACKING

Packing is included in the sales price. A packaging different from the standard will be invoiced at cost (standard plastic pallets at € 11,00 net each).

## TECHNICAL DATA AND DOCUMENTS RELATED TO THE SUPPLY

Weights, dimensions, prices, performance, colours, pictures and other information, including samples characteristics, indicated in AB Industrietechnik Srl's catalogues, price lists, circular letters or other sales and technical literature are merely indicative and not binding, unless AB Industrietechnik Srl expressly refers to them in its quotation or order confirmation.

AB Industrietechnik Srl reserves the right to make changes at any time to its products' technical specifications in order to improve their performance, informing the Buyer in writing in case the above changes are substantial (i.e. changes affecting: products' installation procedures, products' interchangeability features, etc.).

We reserve our rights on all documents referring to the products and/or made available with quotations, acknowledgements or on delivery. Such documents may neither be copied nor made available to third parties without our written agreement. They must be returned to us on request.

## SHIPMENT

Shipment is ex our works in Bressanone, unless otherwise agreed. As soon as the goods are handed over to the forwarder, all our obligations are considered fulfilled. Therefore, all expenses and risks will be the Buyer's responsibility without any exceptions, even if the shipping charges are prepaid by us. It is the Buyer's responsibility to insure the goods against damage and/or loss. We therefore cannot be held liable for damage and/or loss.

The shipping rates for Italy are at cost price, and we reserve the right to select the most suitable means of transport. In case of payment by cash on delivery, the fees are always incurred by us and debited to the Buyer.

## DELIVERY TERMS

Delivery terms are indicative and are not binding. We cannot be held liable for any production or shipment delay, if such a delay is caused by one of the following reasons: a commercial blockade, difficulties in obtaining raw materials and/or other circumstances beyond our control. In that case we do not accept any penalties and the Buyer renounces any claims for indemnity and/or reimbursement of damages.

We reserve the right to deliver the goods before the agreed date.

## CLAIMS

Claims have to be brought to our attention within 8 days after the receipt of the goods, otherwise we will not accept the said claims. Claims do not authorise delays in payment or further price reductions. In case of packing received damaged, the Buyer must inform the forwarder immediately, and send a copy to us for information.

The total liability of AB Industrietechnik Srl, on all claims of any kind, whether in contract, warranty, indemnity, tort (including negligence), strict liability, or otherwise, arising out of the performance or breach of the contract or use of any product, shall not exceed the value of the product such liability is related to.

In no event shall AB Industrietechnik Srl be liable for loss of profit or revenues ("lucro cessante"), loss of use of the product or any associated equipment, claims of Buyer's or third parties for such damages, or for any special, consequential, incidental, indirect or exemplary damages.

## PAYMENT TERMS

Invoices are payable in the currency specified in the invoice. Payments must be remitted within the agreed deadline. We reserve the ownership of the goods until the invoice and any accessory expenses have been fully paid. Failure by the Buyer to pay by the due date automatically gives rise to interest, giving us the right to deem the contract cancelled because of such failure, unless we prefer to ask for settlement of the amount due, by recourse to law if necessary, with bank interest and damages added. If the Buyer stops a payment, the outstanding amount becomes immediately due and we will file a petition for bankruptcy. Interest on arrears: in the case of delayed payments, interest on arrears will be calculated at the rate of 8 (eight) points above the official rate of discount of the Banca d'Italia in force at the time such interest was applied.

## WARRANTY

All the products supplied by us are guaranteed against construction faults or defects of material for 24 months from the date of delivery, the term by which we shall repair the faulty parts in order to restore correct operation of the appliances. We do not accept any responsibility for direct or indirect damage caused by the use of said appliances. Any return of material must be requested from us in writing, must reach us free our works and will be returned ex our works.

The guarantee is restricted exclusively to the repair at our plant of appliances acknowledged to be defective, whereas all other costs of transport or labour for technical operations on the appliances are charged to the Buyer. The guarantee is voided if the appliances are found to have been tampered with or dismantled. If interventions on appliances not considered to be under guarantee are requested, we reserve the right to debit the Buyer for management of the return € 40,00, spare parts, manpower etc. not included. Errors caused by improper or incorrect use, installation and/or commissioning are not subject to any kind of warranty.

In the event of a dispute, the Buyer accepts that the Bolzano Court of Law is competent and accepts the laws in force in Italy.

## BUYER COMMITMENTS

The Buyer is the sole party responsible for the choice of products purchased and for all activities subsequent to sale, namely the installation, handling, assembly, set-up and maintenance of the product at the Buyer's premises. These activities must be carried out in full compliance with the instructions given in the technical documentation. The Buyer must also be in possession of structures and skills (including technological skills) necessary for the correct use of the product.

More specifically, in order to ensure correct installation and subsequent correct function of the product, the Buyer must comply in full and diligently with all obligations listed in the technical documentation.

The Buyer must also comply with and apply all regulations and local rules applicable in the country in which the product is to be used. These include all those concerning the protection of public health and safety and good commercial practice. Any costs relating to the compliance of the product with the rules set out by the legislation of the country in which it is to be used, will be paid for exclusively by the Buyer.

## SOFTWARE

Should the product include a software application, the use of this software may, as applicable, be governed by specific, separate terms and conditions of a use license.

## AUTHOR'S RIGHTS

Without prior written authorization of AB Industrietechnik Srl, the customer is not allowed to copy or reproduce the contents of AB Industrietechnik Srl's catalogue, in particular technical drawings and pictures, for advertising purposes or the like.

These general sale and delivery conditions are subject to the author's right. Legal action will be taken in case of failure to comply with this right.

# CONVERSION CHARTS

	UNIT	FACTOR	UNIT	FACTOR	UNIT
<b>Length</b>	Inches	x 25.4	= mm	x 0.03937	= inches
	Feet	x 0.3048	= m	x 3.208	= feet
<b>Area</b>	Square inches	x 645.16	= mm <sup>2</sup>	0.00155	= in <sup>2</sup>
	Square feet	x 0.0929	= m <sup>2</sup>	x 10.764	= ft <sup>2</sup>
<b>Volume</b>	Cubic inches	x 16387	= mm <sup>3</sup>	0.000061	= in <sup>3</sup>
	Cubic feet	x 0.02832	= m <sup>3</sup>	x 35.31	= ft <sup>3</sup>
	Cubic feet	x 28.32	= litre	x 0.0353	= ft <sup>3</sup>
	Pints	x 0.56825	= litre	x 1.7598	= Pints
	Imp.gal	x 4.546	= litre	x 0.22	= Imp.gal
	Imp.gal	x 0.004546	= m <sup>3</sup>	x 220	= Imp.gal
<b>Mass</b>	lb (pounds)	x 0.4536	= kg	x 2.2046	= lb
<b>Force</b>	lb (pounds)	x 4.448	= N	x 0.22482	= lb
<b>Speed</b>	ft/min	x 0.00508	= m/s	x 196.85	= ft/m
<b>Flow</b>	imp.gal/min	x 0.07577	= l/s	x 13.2	= imp.gal/min
	Imp.gal/h	x 0.000126	= m <sup>3</sup> /s	x 7936.51	= imp.gal/h
	ft <sup>3</sup> /min	x 0.000472	= m <sup>3</sup> /s	x 2118.64	= ft <sup>3</sup> /min
<b>Heating power</b>	kcal/h	x 1.163	= W	x 0.8598	= kcal/h
<b>Pressure</b>	lb/in <sup>2</sup>	x 0.0689	= bar	x 14.5	= lb/in <sup>2</sup>
	lb/in <sup>2</sup>	x 0.0703	= kg/cm <sup>2</sup>	x 14.22	= ib/in <sup>2</sup>
	kg/cm <sup>2</sup>	x 0.9807	= bar	x 1.020	= kg/cm <sup>2</sup>

	kPa	Pa	bar	mmWC	mWC	MPa	kp/CM <sup>2</sup>	psi
1 kPa		1000	0.01	100	0.1	0.001	0.01	0.15
1 Pa	0.001		0.00001	0.1	0.0001	0.000001	0.00001	0.00015
1 bar	100	100000		10000	10	0.1	1	15
1 mmWC	0.01	10	0.0001		0.001	0.00001	0.0001	0.0015
1 mWC	10	10000	0.1	1000		0.01	0.1	1.5
1 MPa	1000	1000000	10	100000	100		10	150
1 kp/cm <sup>2</sup>	100	100000	1	10000	10	0.1		15
1 psi	6.666667	6666.667	0.066667	666.6667	0.666667	0.006667	0.066667	

bar	x 14.50377	= psi
bar	x 100	= kPa
kg/cm <sup>2</sup>	x 14.22334	= psi
inches Hg	x 0.4912	= psi
N/m <sup>2</sup>	x 1.0	= Pa
mbar	x 100	= Pa
°C	x (1.8x°C)+32	= °F
kgcm	x 0.098	= Nm
litre	x 1000	= m <sup>3</sup>
gal (IMP)	x 4.5460	= litre
gal (US)	x 3.7854	= litre
gal (IMP)	x 1.20095	= gal (US)



“We believe that listening and being creative are the keys to innovation and smart solutions.”

#### HEAD OFFICE / VISITING ADDRESS

AB Industrietechnik SRL  
Via Julius Durst 50  
IT-39042 Bressanone (BZ) – Italy

VAT No. IT02748450216

Tel: +39 0472 830626  
Fax: +39 0472 831840  
info@industrietechnik.it

[www.industrietechnik.it](http://www.industrietechnik.it)

